

INTERNATIONAL STANDARD

NORME INTERNATIONALE



**Audio/video, information and communication technology equipment –
Part 1: Safety requirements**

**Équipements des technologies de l'audio/vidéo, de l'information et de la
communication –
Partie 1: Exigences de sécurité**



THIS PUBLICATION IS COPYRIGHT PROTECTED

Copyright © 2014 IEC, Geneva, Switzerland

All rights reserved. Unless otherwise specified, no part of this publication may be reproduced or utilized in any form or by any means, electronic or mechanical, including photocopying and microfilm, without permission in writing from either IEC or IEC's member National Committee in the country of the requester. If you have any questions about IEC copyright or have an enquiry about obtaining additional rights to this publication, please contact the address below or your local IEC member National Committee for further information.

Droits de reproduction réservés. Sauf indication contraire, aucune partie de cette publication ne peut être reproduite ni utilisée sous quelque forme que ce soit et par aucun procédé, électronique ou mécanique, y compris la photocopie et les microfilms, sans l'accord écrit de l'IEC ou du Comité national de l'IEC du pays du demandeur. Si vous avez des questions sur le copyright de l'IEC ou si vous désirez obtenir des droits supplémentaires sur cette publication, utilisez les coordonnées ci-après ou contactez le Comité national de l'IEC de votre pays de résidence.

IEC Central Office
3, rue de Varembe
CH-1211 Geneva 20
Switzerland

Tel.: +41 22 919 02 11
Fax: +41 22 919 03 00
info@iec.ch
www.iec.ch

About the IEC

The International Electrotechnical Commission (IEC) is the leading global organization that prepares and publishes International Standards for all electrical, electronic and related technologies.

About IEC publications

The technical content of IEC publications is kept under constant review by the IEC. Please make sure that you have the latest edition, a corrigenda or an amendment might have been published.

IEC Catalogue - webstore.iec.ch/catalogue

The stand-alone application for consulting the entire bibliographical information on IEC International Standards, Technical Specifications, Technical Reports and other documents. Available for PC, Mac OS, Android Tablets and iPad.

IEC publications search - www.iec.ch/searchpub

The advanced search enables to find IEC publications by a variety of criteria (reference number, text, technical committee,...). It also gives information on projects, replaced and withdrawn publications.

IEC Just Published - webstore.iec.ch/justpublished

Stay up to date on all new IEC publications. Just Published details all new publications released. Available online and also once a month by email.

Electropedia - www.electropedia.org

The world's leading online dictionary of electronic and electrical terms containing more than 30 000 terms and definitions in English and French, with equivalent terms in 14 additional languages. Also known as the International Electrotechnical Vocabulary (IEV) online.

IEC Glossary - std.iec.ch/glossary

More than 55 000 electrotechnical terminology entries in English and French extracted from the Terms and Definitions clause of IEC publications issued since 2002. Some entries have been collected from earlier publications of IEC TC 37, 77, 86 and CISPR.

IEC Customer Service Centre - webstore.iec.ch/csc

If you wish to give us your feedback on this publication or need further assistance, please contact the Customer Service Centre: csc@iec.ch.

A propos de l'IEC

La Commission Electrotechnique Internationale (IEC) est la première organisation mondiale qui élabore et publie des Normes internationales pour tout ce qui a trait à l'électricité, à l'électronique et aux technologies apparentées.

A propos des publications IEC

Le contenu technique des publications IEC est constamment revu. Veuillez vous assurer que vous possédez l'édition la plus récente, un corrigendum ou amendement peut avoir été publié.

Catalogue IEC - webstore.iec.ch/catalogue

Application autonome pour consulter tous les renseignements bibliographiques sur les Normes internationales, Spécifications techniques, Rapports techniques et autres documents de l'IEC. Disponible pour PC, Mac OS, tablettes Android et iPad.

Recherche de publications IEC - www.iec.ch/searchpub

La recherche avancée permet de trouver des publications IEC en utilisant différents critères (numéro de référence, texte, comité d'études,...). Elle donne aussi des informations sur les projets et les publications remplacées ou retirées.

IEC Just Published - webstore.iec.ch/justpublished

Restez informé sur les nouvelles publications IEC. Just Published détaille les nouvelles publications parues. Disponible en ligne et aussi une fois par mois par email.

Electropedia - www.electropedia.org

Le premier dictionnaire en ligne de termes électroniques et électriques. Il contient plus de 30 000 termes et définitions en anglais et en français, ainsi que les termes équivalents dans 14 langues additionnelles. Egalement appelé Vocabulaire Electrotechnique International (IEV) en ligne.

Glossaire IEC - std.iec.ch/glossary

Plus de 55 000 entrées terminologiques électrotechniques, en anglais et en français, extraites des articles Termes et Définitions des publications IEC parues depuis 2002. Plus certaines entrées antérieures extraites des publications des CE 37, 77, 86 et CISPR de l'IEC.

Service Clients - webstore.iec.ch/csc

Si vous désirez nous donner des commentaires sur cette publication ou si vous avez des questions contactez-nous: csc@iec.ch.

CONTENTS

FOREWORD.....	19
INTRODUCTION.....	22
0 Principles of this product safety standard	22
0.1 Objective	22
0.2 Persons	22
0.2.1 General	22
0.2.2 Ordinary person.....	22
0.2.3 Instructed person.....	22
0.2.4 Skilled person.....	22
0.3 Model for pain and injury.....	22
0.4 Energy sources.....	23
0.5 Safeguards	24
0.5.1 General	24
0.5.2 Equipment safeguard.....	25
0.5.3 Installation safeguard	25
0.5.4 Personal safeguard.....	25
0.5.5 Behavioural safeguards	26
0.5.6 Safeguards during ordinary or instructed person service conditions	27
0.5.7 Equipment safeguards during skilled person service conditions	27
0.5.8 Examples of safeguard characteristics	27
0.6 Electrically-caused pain or injury (electric shock).....	28
0.6.1 Models for electrically-caused pain or injury	28
0.6.2 Models for protection against electrically-caused pain or injury.....	29
0.7 Electrically-caused fire.....	30
0.7.1 Models for electrically-caused fire.....	30
0.7.2 Models for protection against electrically-caused fire	31
0.8 Injury caused by hazardous substances	31
0.9 Mechanically-caused injury	32
0.10 Thermally-caused injury (skin burn)	32
0.10.1 Models for thermally-caused injury	32
0.10.2 Models for protection against thermally-caused pain or injury	33
0.11 Radiation-caused injury	34
1 Scope.....	36
2 Normative references	37
3 Terms, definitions and abbreviations	43
3.1 Energy source abbreviations.....	43
3.2 Other abbreviations	43
3.3 Terms and definitions.....	44
3.3.1 Circuit terms	46
3.3.2 Enclosure terms.....	46
3.3.3 Equipment terms	47
3.3.4 Flammability terms	47
3.3.5 Insulation.....	49
3.3.6 Miscellaneous.....	49

3.3.7	Operating and fault conditions	51
3.3.8	Persons	52
3.3.9	Potential ignition sources.....	52
3.3.10	Ratings	53
3.3.11	Safeguards	53
3.3.12	Spacings	55
3.3.13	Temperature controls.....	55
3.3.14	Voltages and currents.....	55
3.3.15	Classes of equipment with respect to protection from electric shock.....	56
3.3.16	Chemical terms.....	57
3.3.17	Batteries	57
4	General requirements	59
4.1	General.....	59
4.1.1	Application of requirements and acceptance of materials, components and subassemblies	59
4.1.2	Use of components	59
4.1.3	Equipment design and construction	59
4.1.4	Equipment installation	60
4.1.5	Constructions and components not specifically covered.....	60
4.1.6	Orientation during transport and use.....	60
4.1.7	Choice of criteria	60
4.1.8	Conductive liquids	60
4.1.9	Electrical measuring instruments	60
4.1.10	Temperature measurements	60
4.1.11	Steady state conditions.....	61
4.1.12	Hierarchy of safeguards.....	61
4.1.13	Examples mentioned in the standard	61
4.1.14	Tests on parts or samples separate from the end-product.....	61
4.1.15	Markings and instructions	61
4.2	Energy source classifications	61
4.2.1	Class 1 energy source	61
4.2.2	Class 2 energy source	62
4.2.3	Class 3 energy source	62
4.2.4	Energy source classification by declaration.....	62
4.3	Protection against energy sources	62
4.3.1	General	62
4.3.2	Safeguards for protection of an ordinary person	62
4.3.3	Safeguards for protection of an instructed person.....	64
4.3.4	Safeguards for protection of a skilled person	64
4.3.5	Safeguards in a restricted access area	65
4.4	Safeguards	66
4.4.1	Equivalent materials or components	66
4.4.2	Composition of a safeguard	66
4.4.3	Accessible parts of a safeguard	66
4.4.4	Safeguard robustness.....	66
4.5	Explosion.....	68
4.5.1	General	68
4.5.2	Requirements	68

4.6	Fixing of conductors.....	69
4.6.1	Requirements	69
4.6.2	Compliance criteria.....	69
4.7	Equipment for direct insertion into mains socket-outlets	69
4.7.1	General	69
4.7.2	Requirements	69
4.7.3	Compliance criteria.....	70
4.8	Products containing lithium coin / button cell batteries	70
4.8.1	General	70
4.8.2	Instructional safeguard	70
4.8.3	Construction	70
4.8.4	Tests	71
4.8.5	Compliance criteria.....	71
4.9	Likelihood of fire or shock due to entry of conductive objects	72
5	Electrically-caused injury.....	72
5.1	General.....	72
5.2	Classification and limits of electrical energy sources.....	73
5.2.1	Electrical energy source classifications.....	73
5.2.2	Electrical energy source ES1 and ES2 limits.....	73
5.3	Protection against electrical energy sources	79
5.3.1	General	79
5.3.2	Accessibility to electrical energy sources and safeguards.....	79
5.4	Insulation materials and requirements.....	81
5.4.1	General	81
5.4.2	Clearances	87
5.4.3	Creepage distances.....	97
5.4.4	Solid insulation	101
5.4.5	Antenna terminal insulation.....	110
5.4.6	Insulation of internal wire as a part of a supplementary safeguard	111
5.4.7	Tests for semiconductor components and for cemented joints	111
5.4.8	Humidity conditioning	111
5.4.9	Electric strength test.....	112
5.4.10	Safeguards against transient voltages from external circuits.....	115
5.4.11	Separation between external circuits and earth.....	117
5.5	Components as safeguards.....	118
5.5.1	General	118
5.5.2	Capacitors and RC units	118
5.5.3	Transformers	120
5.5.4	Optocouplers	120
5.5.5	Relays	120
5.5.6	Resistors	120
5.5.7	SPDs.....	120
5.5.8	Insulation between the mains and an external circuit consisting of a coaxial cable	121
5.6	Protective conductor	121
5.6.1	General	121
5.6.2	Requirements for protective conductors	121
5.6.3	Requirements for protective earthing conductors	122

	5.6.4	Requirements for protective bonding conductors	123
	5.6.5	Terminals for protective conductors	125
	5.6.6	Resistance of the protective bonding system	126
	5.6.7	Reliable earthing	128
5.7		Prospective touch voltage, touch current and protective conductor current.....	128
	5.7.1	General	128
	5.7.2	Measuring devices and networks	128
	5.7.3	Equipment set-up, supply connections and earth connections.....	128
	5.7.4	Earthed accessible conductive parts	129
	5.7.5	Protective conductor current.....	129
	5.7.6	Prospective touch voltage and touch current due to external circuits.....	130
	5.7.7	Summation of touch currents from external circuits.....	131
6		Electrically-caused fire	133
	6.1	General.....	133
	6.2	Classification of power sources (PS) and potential ignition sources (PIS)	133
	6.2.1	General	133
	6.2.2	Power source circuit classifications	133
	6.2.3	Classification of potential ignition sources	136
	6.3	Safeguards against fire under normal operating conditions and abnormal operating conditions.....	137
	6.3.1	Requirements	137
	6.3.2	Compliance criteria.....	138
	6.4	Safeguards against fire under single fault conditions.....	138
	6.4.1	General	138
	6.4.2	Reduction of the likelihood of ignition under single fault conditions in PS1 circuits.....	138
	6.4.3	Reduction of the likelihood of ignition under single fault conditions in PS2 circuits and PS3 circuits	138
	6.4.4	Control of fire spread in PS1 circuits.....	140
	6.4.5	Control of fire spread in PS2 circuits.....	140
	6.4.6	Control of fire spread in a PS3 circuit	141
	6.4.7	Separation of combustible materials from a PIS.....	142
	6.4.8	Fire enclosures and fire barriers	144
	6.5	Internal and external wiring.....	149
	6.5.1	Requirements	149
	6.5.2	Compliance criteria.....	149
	6.5.3	Requirements for interconnection to building wiring.	149
	6.5.4	Compliance criteria.....	150
	6.6	Safeguards against fire due to the connection of additional equipment.....	150
7		Injury caused by hazardous substances	150
	7.1	General.....	150
	7.2	Reduction of exposure to hazardous substances.....	150
	7.3	Ozone exposure.....	150
	7.4	Use of personal safeguards (PPE)	150
	7.5	Use of instructional safeguards and instructions	151
	7.6	Batteries and their protection circuits	151
8		Mechanically-caused injury.....	151
	8.1	General.....	151

8.2	Mechanical energy source classifications.....	151
8.2.1	General classification	151
8.2.2	MS1.....	153
8.2.3	MS2.....	153
8.2.4	MS3.....	153
8.3	Safeguards against mechanical energy sources.....	153
8.4	Safeguards against parts with sharp edges and corners	153
8.4.1	Requirements	153
8.4.2	Compliance criteria.....	154
8.5	Safeguards against moving parts	154
8.5.1	Requirements	154
8.5.2	Instructional safeguard requirements	154
8.5.3	Compliance criteria.....	155
8.5.4	Special categories of equipment comprising moving parts	155
8.5.5	High pressure lamps.....	157
8.6	Stability of equipment	158
8.6.1	Requirements	158
8.6.2	Static stability	159
8.6.3	Relocation stability test.....	160
8.6.4	Glass slide test.....	160
8.6.5	Horizontal force test and compliance criteria.....	161
8.7	Equipment mounted to a wall or ceiling	161
8.7.1	Requirements	161
8.7.2	Test methods.....	161
8.7.3	Compliance criteria.....	163
8.8	Handle strength	163
8.8.1	General	163
8.8.2	Test method and compliance criteria	163
8.9	Wheels or casters attachment requirements.....	163
8.9.1	General	163
8.9.2	Test method	164
8.10	Carts, stands, and similar carriers.....	164
8.10.1	General	164
8.10.2	Marking and instructions	164
8.10.3	Cart, stand or carrier loading test and compliance criteria.....	165
8.10.4	Cart, stand or carrier impact test.....	165
8.10.5	Mechanical stability	165
8.10.6	Thermoplastic temperature stability	166
8.11	Mounting means for rack mounted equipment	166
8.11.1	General	166
8.11.2	Requirements	166
8.11.3	Mechanical strength test.....	167
8.11.4	Mechanical strength test, 250 N, including end stops.....	167
8.11.5	Compliance criteria.....	167
8.12	Telescoping or rod antennas	167
9	Thermal burn injury	168
9.1	General.....	168
9.2	Thermal energy source classifications.....	168
9.2.1	General	168

9.2.2	TS1	168
9.2.3	TS2	168
9.2.4	TS3	168
9.2.5	Test method and compliance criteria	168
9.2.6	Touch temperature levels	169
9.3	Safeguards against thermal energy sources	170
9.4	Requirements for safeguards	170
9.4.1	Equipment safeguard	170
9.4.2	Instructional safeguard	170
10	Radiation	170
10.1	General	170
10.2	Radiation energy source classifications	170
10.2.1	General classification	170
10.2.2	RS1	172
10.2.3	RS2	172
10.2.4	RS3	172
10.3	Safeguards against laser radiation	172
10.3.1	Requirements	172
10.3.2	Compliance criteria	172
10.4	Safeguards against visible, infra-red, and ultra-violet radiation	173
10.4.1	General	173
10.4.2	Instructional safeguard	173
10.4.3	Compliance criteria	174
10.5	Safeguards against x-radiation	174
10.5.1	Requirements	174
10.5.2	Compliance criteria	174
10.5.3	Test method	174
10.6	Safeguards against acoustic energy sources	175
10.6.1	General	175
10.6.2	Classification	176
10.6.3	Measurement methods	176
10.6.4	Protection of persons	177
10.6.5	Requirements for listening devices (headphones, earphones, etc.)	177
Annex A (informative) Examples of equipment within the scope of this standard		179
Annex B (normative) Normal operating condition tests, abnormal operating condition tests and single fault condition tests		180
B.1	General	180
B.1.1	Introduction	180
B.1.2	Test applicability	180
B.1.3	Type of test	180
B.1.4	Test samples	180
B.1.5	Compliance by inspection of relevant data	180
B.1.6	Temperature measurement conditions	180
B.2	Normal operating conditions	181
B.2.1	General	181
B.2.2	Supply frequency	181
B.2.3	Supply voltage	181
B.2.4	Normal operating voltages	182

B.2.5	Input test	182
B.2.6	Operating temperature measurement conditions	183
B.2.7	Battery charging and discharging under normal operating conditions	183
B.3	Simulated abnormal operating conditions	184
B.3.1	General	184
B.3.2	Covering of ventilation openings	184
B.3.3	DC mains polarity test	185
B.3.4	Setting of voltage selector	185
B.3.5	Maximum load at output terminals	185
B.3.6	Reverse battery polarity	185
B.3.7	Audio amplifier abnormal operating conditions	185
B.3.8	Compliance criteria during and after abnormal operating conditions	185
B.4	Simulated single fault conditions	185
B.4.1	General	185
B.4.2	Temperature controlling device	186
B.4.3	Motor tests	186
B.4.4	Functional insulation	186
B.4.5	Short-circuit and interruption of electrodes in tubes and semiconductors	187
B.4.6	Short-circuit or disconnection of passive components	187
B.4.7	Continuous operation of components	187
B.4.8	Compliance criteria during and after single fault conditions	188
B.4.9	Battery charging and discharging under single fault conditions	188
Annex C (normative)	UV radiation	189
C.1	Protection of materials in equipment from UV radiation	189
C.1.1	General	189
C.1.2	Requirements	189
C.1.3	Test method and compliance criteria	189
C.2	UV light conditioning test	190
C.2.1	Test apparatus	190
C.2.2	Mounting of test samples	190
C.2.3	Carbon-arc light-exposure test	190
C.2.4	Xenon-arc light-exposure test	190
Annex D (normative)	Test generators	191
D.1	Impulse test generators	191
D.2	Antenna interface test generator	192
D.3	Electronic pulse generator	192
Annex E (normative)	Test conditions for equipment containing audio amplifiers	193
E.1	Audio amplifier normal operating conditions	193
E.2	Audio amplifier abnormal operating conditions	194
Annex F (normative)	Equipment markings, instructions, and instructional safeguards	195
F.1	General	195
F.2	Letter symbols and graphical symbols	195
F.2.1	Letter symbols	195
F.2.2	Graphical symbols	195
F.2.3	Compliance criteria	195
F.3	Equipment markings	195

F.3.1	Equipment marking locations	195
F.3.2	Equipment identification markings	196
F.3.3	Equipment rating markings	196
F.3.4	Voltage setting device	198
F.3.5	Markings on terminals and operating devices.....	198
F.3.6	Equipment markings related to equipment classification	199
F.3.7	Equipment IP rating marking.....	200
F.3.8	External power supply output marking	200
F.3.9	Durability, legibility and permanence of markings	201
F.3.10	Test for the permanence of markings	201
F.4	Instructions	201
F.5	Instructional safeguards	202
Annex G (normative)	Components	205
G.1	Switches	205
G.1.1	General	205
G.1.2	Requirements	205
G.1.3	Test method and compliance criteria	206
G.2	Relays	206
G.2.1	Requirements	206
G.2.2	Overload test.....	207
G.2.3	Relay controlling connectors supplying power to other equipment.....	207
G.2.4	Test method and compliance criteria	207
G.3	Protective devices.....	207
G.3.1	Thermal cut-offs	207
G.3.2	Thermal links	208
G.3.3	PTC thermistors.....	209
G.3.4	Overcurrent protective devices	210
G.3.5	Safeguard components not mentioned in G.3.1 to G.3.4	210
G.4	Connectors	210
G.4.1	Clearance and creepage distance requirements	210
G.4.2	Mains connectors	210
G.4.3	Connectors other than mains connectors	211
G.5	Wound components	211
G.5.1	Wire insulation in wound components	211
G.5.2	Endurance test	211
G.5.3	Transformers	213
G.5.4	Motors	216
G.6	Wire insulation	220
G.6.1	General	220
G.6.2	Solvent-based enamel winding insulation.....	221
G.7	Mains supply cords	221
G.7.1	General	221
G.7.2	Cross sectional area	222
G.7.3	Cord anchorages and strain relief for non-detachable power supply cords	224
G.7.4	Cord entry	225
G.7.5	Non-detachable cord bend protection	225
G.7.6	Supply wiring space.....	226

G.8	Varistors	227
	G.8.1 General	227
	G.8.2 Safeguards against electric shock	227
	G.8.3 Safeguards against fire	228
G.9	Integrated circuit (IC) current limiters	230
	G.9.1 Requirements	230
	G.9.2 Test program 1	230
	G.9.3 Test program 2	231
	G.9.4 Test program 3	231
	G.9.5 Compliance criteria	232
G.10	Resistors	232
	G.10.1 General	232
	G.10.2 Resistor test	232
	G.10.3 Resistors serving as safeguards between the mains and an external circuit consisting of a coaxial cable	232
G.11	Capacitors and RC units	233
	G.11.1 General	233
	G.11.2 Conditioning of capacitors and RC units	233
	G.11.3 Rules for selecting capacitors	233
	G.11.4 Examples of the application of capacitors	234
G.12	Optocouplers	237
G.13	Printed boards	237
	G.13.1 General	237
	G.13.2 Uncoated printed boards	237
	G.13.3 Coated printed boards	237
	G.13.4 Insulation between conductors on the same inner surface	239
	G.13.5 Insulation between conductors on different surfaces	240
	G.13.6 Tests on coated printed boards	240
G.14	Coatings on component terminals	242
	G.14.1 Requirements	242
	G.14.2 Test method and compliance criteria	242
G.15	Pressurized liquid filled components	243
	G.15.1 General	243
	G.15.2 Requirements	243
	G.15.3 Test methods and compliance criteria	243
	G.15.4 Compliance criteria	244
G.16	IC including capacitor discharge function (ICX)	244
	G.16.1 Requirements	244
	G.16.2 Tests	245
	G.16.3 Compliance criteria	245
Annex H (normative)	Criteria for telephone ringing signals	246
	H.1 General	246
	H.2 Method A	246
	H.3 Method B	249
	H.3.1 Ringing signal	249
	H.3.2 Tripping device and monitoring voltage	249
Annex I (informative)	Overvoltage categories (see IEC 60364-4-44)	251
Annex J (normative)	Insulated winding wires for use without interleaved insulation	252
	J.1 General	252

J.2	Type tests	252
J.2.1	General	252
J.2.2	Electric strength	252
J.2.3	Flexibility and adherence	253
J.2.4	Heat shock	253
J.2.5	Retention of electric strength after bending.....	254
J.3	Testing during manufacturing	254
J.3.1	General	254
J.3.2	Routine test	254
J.3.3	Sampling test.....	254
Annex K (normative)	Safety interlocks	255
K.1	General.....	255
K.1.1	General requirements	255
K.1.2	Test method and compliance criteria	255
K.2	Components of the safety interlock safeguard mechanism	256
K.3	Inadvertent change of operating mode	256
K.4	Interlock safeguard override.....	256
K.5	Fail-safe	256
K.5.1	Requirement.....	256
K.5.2	Test method and compliance criteria	256
K.6	Mechanically operated safety interlocks	257
K.6.1	Endurance requirement	257
K.6.2	Test method and compliance criteria	257
K.7	Interlock circuit isolation	257
K.7.1	Separation distances for contact gaps and interlock circuit elements.....	257
K.7.2	Overload test.....	257
K.7.3	Endurance test	258
K.7.4	Electric strength test.....	258
Annex L (normative)	Disconnect devices.....	259
L.1	General requirements	259
L.2	Permanently connected equipment	259
L.3	Parts that remain energized	259
L.4	Single-phase equipment.....	259
L.5	Three-phase equipment	260
L.6	Switches as disconnect devices	260
L.7	Plugs as disconnect devices	260
L.8	Multiple power sources	260
L.9	Compliance criteria	261
Annex M (normative)	Equipment containing batteries and their protection circuits.....	262
M.1	General requirements	262
M.2	Safety of batteries and their cells	262
M.2.1	Requirements	262
M.2.2	Compliance criteria.....	262
M.3	Protection circuits for batteries provided within the equipment	263
M.3.1	Requirements	263
M.3.2	Test method	263
M.3.3	Compliance criteria.....	264

M.4	Additional safeguards for equipment containing a secondary lithium battery	264
M.4.1	General	264
M.4.2	Charging safeguards	264
M.4.3	Fire enclosure.....	265
M.4.4	Drop test of equipment containing a secondary lithium battery.....	266
M.5	Risk of burn due to short-circuit during carrying	267
M.5.1	Requirements	267
M.5.2	Test method and compliance criteria	267
M.6	Prevention of short-circuits and protection from other effects of electric current	267
M.6.1	Short-circuits	267
M.6.2	Leakage currents.....	268
M.7	Risk of explosion from lead acid and NiCd batteries.....	268
M.7.1	Ventilation preventing an explosive gas concentration	268
M.7.2	Test method and compliance criteria	268
M.8	Protection against internal ignition from external spark sources of batteries with aqueous electrolyte	270
M.8.1	General	270
M.8.2	Test method	270
M.9	Preventing electrolyte spillage	273
M.9.1	Protection from electrolyte spillage	273
M.9.2	Tray for preventing electrolyte spillage	273
M.10	Instructions to prevent reasonably foreseeable misuse	273
Annex N (normative)	Electrochemical potentials (V).....	274
Annex O (normative)	Measurement of creepage distances and clearances	275
Annex P (normative)	Safeguards against conductive objects	283
P.1	General.....	283
P.2	Safeguards against entry or consequences of entry of a foreign object	283
P.2.1	General	283
P.2.2	Safeguards against entry of a foreign object	283
P.2.3	Safeguards against the consequences of entry of a foreign object	284
P.3	Safeguards against spillage of internal liquids.....	286
P.3.1	General	286
P.3.2	Determination of spillage consequences	286
P.3.3	Spillage safeguards	286
P.3.4	Compliance criteria.....	287
P.4	Metallized coatings and adhesives securing parts	287
P.4.1	General	287
P.4.2	Tests	287
Annex Q (normative)	Circuits intended for interconnection with building wiring	290
Q.1	Limited power source	290
Q.1.1	Requirements	290
Q.1.2	Test method and compliance criteria	290
Q.2	Test for external circuits – paired conductor cable	291
Annex R (normative)	Limited short-circuit test.....	292
R.1	General.....	292
R.2	Test setup.....	292

R.3	Test method.....	292
R.4	Compliance criteria	293
Annex S (normative)	Tests for resistance to heat and fire	294
S.1	Flammability test for fire enclosure and fire barrier materials of equipment where the steady-state power does not exceed 4 000 W	294
S.2	Flammability test for fire enclosure and fire barrier integrity	295
S.3	Flammability tests for the bottom of a fire enclosure	296
S.3.1	Mounting of samples.....	296
S.3.2	Test method and compliance criteria	296
S.4	Flammability classification of materials	296
S.5	Flammability test for fire enclosure materials of equipment with a steady-state power exceeding 4 000 W	297
Annex T (normative)	Mechanical strength tests.....	299
T.1	General.....	299
T.2	Steady force test, 10 N	299
T.3	Steady force test, 30 N	299
T.4	Steady force test, 100 N	299
T.5	Steady force test, 250 N	299
T.6	Enclosure impact test.....	299
T.7	Drop test.....	300
T.8	Stress relief test.....	300
T.9	Impact test.....	301
T.10	Glass fragmentation test	301
T.11	Test for telescoping or rod antennas	302
Annex U (normative)	Mechanical strength of CRTs and protection against the effects of implosion.....	303
U.1	General.....	303
U.2	Test method and compliance criteria for non-intrinsically protected CRTs	304
U.3	Protective screen	304
Annex V (normative)	Determination of accessible parts	305
V.1	Accessible parts of equipment	305
V.1.1	General	305
V.1.2	Test method 1 – Surfaces and openings tested with jointed test probes	305
V.1.3	Test method 2 – Openings tested with straight unjointed test probes	305
V.1.4	Test method 3 – Plugs, jacks, connectors	308
V.1.5	Test method 4 – Slot openings	309
V.1.6	Test method 5 – Terminals intended to be used by an ordinary person	309
V.2	Accessible part criterion.....	310
Annex W (informative)	Comparison of terms introduced in this standard	311
W.1	General.....	311
W.2	Comparison of terms.....	311
Bibliography.....		324
Figure 1 – Three block model for pain and injury.....		23
Figure 2 – Three block model for safety		24
Figure 3 – Schematic and model for electrically-caused pain or injury.....		29

Figure 4 – Model for protection against electrically-caused pain or injury	29
Figure 5 – Model for electrically-caused fire	30
Figure 6 – Models for protection against fire	31
Figure 7 – Schematic and model for thermally-caused injury	33
Figure 8 – Model for protection against thermally-caused injury	34
Figure 9 – Model for protection of an ordinary person against a class 1 energy source	62
Figure 10 – Model for protection of an ordinary person against a class 2 energy source	63
Figure 11 – Model for protection of an ordinary person against a class 2 energy source during ordinary person servicing conditions	63
Figure 12 – Model for protection of an ordinary person against a class 3 energy source	63
Figure 13 – Model for protection of an instructed person against a class 1 energy source	64
Figure 14 – Model for protection of an instructed person against a class 2 energy source	64
Figure 15 – Model for protection of an instructed person against a class 3 energy source	64
Figure 16 – Model for protection of a skilled person against a class 1 energy source	65
Figure 17 – Model for protection of a skilled person against a class 2 energy source	65
Figure 18 – Model for protection of a skilled person against a class 3 energy source	65
Figure 19 – Model for protection of a skilled person against class 3 energy sources during equipment servicing conditions	65
Figure 20 – Test hook	72
Figure 21 – Illustration showing ES limits for voltage and current	74
Figure 22 – Maximum values for combined a.c. current and d.c. current	76
Figure 23 – Maximum values for combined a.c. voltage and d.c. voltage	76
Figure 24 – Contact requirements to bare internal conductive parts	80
Figure 25 – Mandrel	105
Figure 26 – Initial position of mandrel	106
Figure 27 – Final position of mandrel	106
Figure 28 – Position of metal foil on insulating material	106
Figure 29 – Example of electric strength test instrument for solid insulation	114
Figure 30 – Application points of test voltage	115
Figure 31 – Test for separation between an external circuit and earth	118
Figure 32 – Test circuit for touch current of single-phase equipment	131
Figure 33 – Test circuit for touch current of three-phase equipment	131
Figure 34 – Power measurement for worst-case fault	134
Figure 35 – Power measurement for worst-case power source fault	135
Figure 36 – Illustration of power source classification	136
Figure 37 – Minimum separation requirements from an arcing PIS	142
Figure 38 – Extended separation requirements from a PIS	142
Figure 39 – Rotated separation requirements due to forced air flow	143
Figure 40 – Deflected separation requirements from a PIS when a fire barrier is used	144
Figure 41 – Top openings	146
Figure 42 – Bottom openings	147
Figure 43 – Limits for moving fan blades made of non-plastic materials	152

Figure 44 – Limits for moving fan blades made of plastic materials	152
Figure D.1 – 1,2/50 μ s and 10/700 μ s voltage impulse generator	191
Figure D.2 – Antenna interface test generator circuit	192
Figure D.3 – Example of an electronic pulse generator	192
Figure E.1 – Band-pass filter for wide-band noise measurement	194
Figure F.1 – Example of an instructional safeguard.....	203
Figure G.1 – Determination of arithmetic average temperature	215
Figure G.2 – Thermal ageing time.....	241
Figure G.3 – Abrasion resistance test for coating layers	242
Figure H.1 – Definition of ringing period and cadence cycle	247
Figure H.2 – I_{TS1} limit curve for cadenced ringing signal	248
Figure H.3 – Peak and peak-to-peak currents	248
Figure H.4 – Ringing voltage trip criteria	250
Figure M.1 – Distance d as a function of the rated capacity for various charge currents I (mA/Ah).....	272
Figure O.1 – Narrow groove.....	275
Figure O.2 – Wide groove	275
Figure O.3 – V-shaped groove	276
Figure O.4 – Intervening unconnected conductive part.....	276
Figure O.5 – Rib	276
Figure O.6 – Uncemented joint with narrow groove	276
Figure O.7 – Uncemented joint with wide groove	277
Figure O.8 – Uncemented joint with narrow and wide grooves	277
Figure O.9 – Narrow recess	278
Figure O.10 – Wide recess	278
Figure O.11– Coating around terminals.....	278
Figure O.12 – Coating over printed wiring	279
Figure O.13 – Example of measurements in an enclosure of insulating material.....	279
Figure O.14 – Cemented joints in multi-layer printed boards	280
Figure O.15 – Device filled with insulating compound	280
Figure O.16 – Partitioned bobbin	280
Figure O.17 – Materials with different CTI values.....	281
Figure O.18 – Materials with different CTI values having an air gap of less than X mm	281
Figure O.19 – Materials with different CTI values having an air groove of less than X mm	282
Figure O.20 – Materials with different CTI values having an air groove not smaller than X mm	282
Figure P.1 – Examples of cross-sections of designs of top openings which prevent vertical entry.....	284
Figure P.2 – Examples of cross-sections of designs of side opening louvres which prevent vertical entry	284
Figure P.3 – Internal volume locus for foreign object entry.....	285
Figure T.1 – Impact test using sphere	300
Figure V.1 – Jointed test probe for equipment likely to be accessible to children.....	306
Figure V.2 – Jointed test probe for equipment not likely to be accessible to children.....	307

Figure V.3 – Blunt probe	308
Figure V.4 – Wedge probe	309
Figure V.5 – Terminal probe	310
Table 1 – Response to energy class	23
Table 2 – Examples of body response or property damage related to energy sources	24
Table 3 – Examples of safeguard characteristics	28
Table 4 – Electrical energy source limits for steady-state ES1 and ES2	75
Table 5 – Electrical energy source limits for a charged capacitor	77
Table 6 – Voltage limits for single pulses	78
Table 7 – Current limits for single pulses	78
Table 8 – Electrical energy source limits for repetitive pulses	79
Table 9 – Minimum air gap distance	80
Table 10 – Temperature limits for materials, components and systems	83
Table 11 – Minimum clearances for voltages with frequencies up to 30 kHz	89
Table 12 – Minimum clearances for voltages with frequencies above 30 kHz	90
Table 13 – Mains transient voltages	91
Table 14 – External circuit transient voltages	93
Table 15 – Minimum clearances using required withstand voltage	95
Table 16 – Electric strength test voltages	96
Table 17 – Multiplication factors for clearances and test voltages	96
Table 18 – Minimum creepage distances for basic insulation and supplementary insulation in mm	100
Table 19 – Minimum values of creepage distances (in mm) for frequencies higher than 30 kHz and up to 400 kHz	101
Table 20 – Tests for insulation in non-separable layers	104
Table 21 – Electric field strength E_P for some commonly used materials	108
Table 22 – Reduction factors for the value of breakdown electric field strength E_P at higher frequencies	109
Table 23 – Reduction factors for the value of breakdown electric field strength E_P at higher frequencies for thin materials	109
Table 24 – Values for insulation resistance	110
Table 25 – Distance through insulation of internal wiring	111
Table 26 – Test voltages for electric strength tests based on transient voltages	113
Table 27 – Test voltages for electric strength tests based on peak working voltages	113
Table 28 – Test voltages for electric strength tests based on temporary overvoltages	114
Table 29 – Test values for electric strength tests	116
Table 30 – Protective earthing conductor sizes for reinforced safeguards for permanently connected equipment	123
Table 31 – Minimum protective bonding conductor size of copper conductors	124
Table 32 – Sizes of terminals for protective conductors	126
Table 33 – Test duration, mains connected equipment	127
Table 34 – Size and spacing of holes in metal bottoms of fire enclosures	148
Table 35 – Classification for various categories of mechanical energy sources	151
Table 36 – Overview of requirements and tests	158

Table 37 – Torque to be applied to screws.....	162
Table 38 – Touch temperature limits for accessible parts.....	169
Table 39 – Radiation energy source classifications.....	171
Table C.1 – Minimum property retention limits after UV exposure.....	189
Table D.1 – Component values for Figure D.1 and Figure D.2.....	192
Table E.1 – Audio signal electrical energy source classes and safeguards.....	194
Table F.1 – Instructional safeguard element description and examples.....	203
Table F.2 – Examples of markings, instructions, and instructional safeguards.....	204
Table G.1 – Peak surge current.....	206
Table G.2 – Test temperature and testing time (days) per cycle.....	212
Table G.3 – Temperature limits for transformer windings and for motor windings (except for the motor running overload test).....	215
Table G.4 – Temperature limits for running overload tests.....	217
Table G.5 – Sizes of conductors.....	223
Table G.6– Strain relief test force.....	224
Table G.7 – Varistor overload and temporary overvoltage test.....	228
Table G.8 – Capacitor ratings according to IEC 60384-14.....	234
Table G.9 – Examples of the application of Y capacitors based on the test voltages of Table 26.....	235
Table G.10 – Examples of the application of Y capacitors based on the test voltages of Table 27.....	236
Table G.11 – Examples of the application of Y capacitors based on the test voltages of Table 28.....	236
Table G.12 – Examples of the application of X capacitors, line to line or line to neutral.....	237
Table G.13 – Minimum separation distances for coated printed boards.....	239
Table G.14 – Insulation in printed boards.....	240
Table I.1 – Overvoltage categories.....	251
Table J.1 – Mandrel diameter.....	253
Table J.2 – Oven temperature.....	254
Table M.1 – Values of f_g and f_s	269
Table O.1 – Value of X	275
Table Q.1 – Limits for inherently limited power sources.....	290
Table Q.2 – Limits for power sources not inherently limited (overcurrent protective device required).....	291
Table S.1 – Foamed materials.....	297
Table S.2 – Rigid materials.....	297
Table S.3 – Very thin materials.....	297
Table T.1 – Impact force.....	301
Table T.2 – Torque values for end-piece test.....	302
Table W.1 – Comparison of terms and definitions in IEC 60664-1:2007 and IEC 62368-1.....	311
Table W.2 – Comparison of terms and definitions in IEC 61140:2001 and IEC 62368-1.....	313
Table W.3 – Comparison of terms and definitions in IEC 60950-1:2005 and IEC 62368-1.....	316
Table W.4 – Comparison of terms and definitions in IEC 60728-11 and IEC 62368-1.....	319

Table W.5 – Comparison of terms and definitions in IEC 62151 and IEC 62368-1	320
Table W.6 – Comparison of terms and definitions in IEC 60065 and IEC 62368-1	321

INTERNATIONAL ELECTROTECHNICAL COMMISSION

AUDIO/VIDEO, INFORMATION AND COMMUNICATION TECHNOLOGY EQUIPMENT –

Part 1: Safety requirements

FOREWORD

- 1) The International Electrotechnical Commission (IEC) is a worldwide organization for standardization comprising all national electrotechnical committees (IEC National Committees). The object of IEC is to promote international co-operation on all questions concerning standardization in the electrical and electronic fields. To this end and in addition to other activities, IEC publishes International Standards, Technical Specifications, Technical Reports, Publicly Available Specifications (PAS) and Guides (hereafter referred to as "IEC Publication(s)"). Their preparation is entrusted to technical committees; any IEC National Committee interested in the subject dealt with may participate in this preparatory work. International, governmental and non-governmental organizations liaising with the IEC also participate in this preparation. IEC collaborates closely with the International Organization for Standardization (ISO) in accordance with conditions determined by agreement between the two organizations.
- 2) The formal decisions or agreements of IEC on technical matters express, as nearly as possible, an international consensus of opinion on the relevant subjects since each technical committee has representation from all interested IEC National Committees.
- 3) IEC Publications have the form of recommendations for international use and are accepted by IEC National Committees in that sense. While all reasonable efforts are made to ensure that the technical content of IEC Publications is accurate, IEC cannot be held responsible for the way in which they are used or for any misinterpretation by any end user.
- 4) In order to promote international uniformity, IEC National Committees undertake to apply IEC Publications transparently to the maximum extent possible in their national and regional publications. Any divergence between any IEC Publication and the corresponding national or regional publication shall be clearly indicated in the latter.
- 5) IEC itself does not provide any attestation of conformity. Independent certification bodies provide conformity assessment services and, in some areas, access to IEC marks of conformity. IEC is not responsible for any services carried out by independent certification bodies.
- 6) All users should ensure that they have the latest edition of this publication.
- 7) No liability shall attach to IEC or its directors, employees, servants or agents including individual experts and members of its technical committees and IEC National Committees for any personal injury, property damage or other damage of any nature whatsoever, whether direct or indirect, or for costs (including legal fees) and expenses arising out of the publication, use of, or reliance upon, this IEC Publication or any other IEC Publications.
- 8) Attention is drawn to the Normative references cited in this publication. Use of the referenced publications is indispensable for the correct application of this publication.
- 9) Attention is drawn to the possibility that some of the elements of this IEC Publication may be the subject of patent rights. IEC shall not be held responsible for identifying any or all such patent rights.

International Standard IEC 62368-1 has been prepared by TC 108: Safety of electronic equipment within the field of audio/video, information technology and communication technology.

This second edition cancels and replaces the first edition published in 2010. It constitutes a technical revision.

This edition includes the following significant technical changes with respect to the previous edition:

- addition of requirements for LEDs;
- new requirements for wall and ceiling mounting means;
- addition of acoustic shock requirements for personal music players;
- revision of the battery requirements, including new requirements for coin / button cell batteries;
- revision of the burn requirements.

The text of this standard is based on the following documents:

FDIS	Report on voting
108/521/FDIS	108/531/RVD

Full information on the voting for the approval of this standard can be found in the report on voting indicated in the above table.

This publication has been drafted in accordance with the ISO/IEC Directives, Part 2.

A list of all parts in the IEC 62368 series, published under the general title *Audio/video, information and communication technology equipment*, can be found on the IEC website.

The “in some countries” notes regarding differing national practices are contained in the following subclauses:

0.2.1, 1, 4.1.15, 4.7.3, 5.2.2.2, 5.4.2.3.2.4, 5.4.2.5, 5.4.5.1, 5.5.2.1, 5.5.6, 5.6.4.2, 5.7.5, 5.7.6.1, 10.5.3, 10.6.2.1, F.3.3.6, Table 13, Table 14 and Table 39.

In this standard, the following print types or formats are used:

- requirements proper and normative annexes: in roman type;
- compliance statements and test specifications: *in italic type*;
- notes/explanatory matter: in smaller roman type;
- normative conditions within tables: in smaller roman type;
- terms that are defined in 3.3: **bold**.

In figures and tables, if colour is available:

- green colour denotes a class 1 energy source;
- yellow colour denotes a class 2 energy source;
- red colour denotes a class 3 energy source.

The committee has decided that the contents of this publication will remain unchanged until the maintenance result date indicated on the IEC web site under "<http://webstore.iec.ch>" in the data related to the specific publication. At this date, the publication will be

- reconfirmed,
- withdrawn,
- replaced by a revised edition, or
- amended.

NOTE 1 The attention of National Committees is drawn to the fact that equipment manufacturers and testing organizations may need a transitional period following publication of a new, amended or revised IEC publication in which to make products in accordance with the new requirements and to equip themselves for conducting new or revised tests. It is the recommendation of the committee that the content of this publication be adopted for mandatory implementation nationally not earlier than five years from the date of publication of this standard.

NOTE 2 IEC 62368-1 is based on the principles of hazard based safety engineering, which is a different way of developing and specifying safety considerations than that of the current practice. While this standard is different from traditional IEC safety standards in its approach and while it is believed that IEC 62368-1 provides a number of advantages, its introduction and evolution is not intended to result in significant changes to the existing safety philosophy that led to the development of the safety requirements contained in IEC 60065 and IEC 60950-1. The predominant reason behind the creation of IEC 62368-1 is to simplify the problems created by the merging of the technologies of ITE and CE. The techniques used are novel so that a learning process is required and experience is needed in its application. Consequently, the committee recommends that this edition of the standard be considered as an alternative to IEC 60065 or IEC 60950-1 at least over the recommended transition period.

NOTE 3 Explanatory information related to IEC 62368-1 is contained in IEC/TR 62368-2. It provides rationale together with explanatory information related to this standard.

IMPORTANT – The 'colour inside' logo on the cover page of this publication indicates that it contains colours which are considered to be useful for the correct understanding of its contents. Users should therefore print this document using a colour printer.

INTRODUCTION

0 Principles of this product safety standard

0.1 Objective

This part of IEC 62368 is a product safety standard that classifies energy sources, prescribes **safeguards** against those energy sources, and provides guidance on the application of, and requirements for, those **safeguards**.

The prescribed **safeguards** are intended to reduce the likelihood of pain, injury and, in the case of fire, property damage.

The objective of the INTRODUCTION is to help designers to understand the underlying principles of safety in order to design safe equipment. These principles are informative and not an alternative to the detailed requirements of this standard.

0.2 Persons

0.2.1 General

This standard describes **safeguards** for the protection of three kinds of persons: the **ordinary person**, the **instructed person**, and the **skilled person**. This standard assumes that a person will not intentionally create conditions or situations that could cause pain or injury.

NOTE In Australia, the work conducted by an **instructed person** or **skilled person** may require formal licensing from regulatory authorities.

0.2.2 Ordinary person

Ordinary person is the term applied to all persons other than **instructed persons** and **skilled persons**. **Ordinary persons** include not only users of the equipment, but also all persons who may have access to the equipment or who may be in the vicinity of the equipment. Under **normal operating conditions** or **abnormal operating conditions**, **ordinary persons** should not be exposed to parts comprising energy sources capable of causing pain or injury. Under a **single fault condition**, **ordinary persons** should not be exposed to parts comprising energy sources capable of causing injury.

0.2.3 Instructed person

Instructed person is a term applied to persons who have been instructed and trained by a **skilled person**, or who are supervised by a **skilled person**, to identify energy sources that may cause pain (see Table 1) and to take precautions to avoid unintentional contact with or exposure to those energy sources. Under **normal operating conditions**, **abnormal operating conditions** or **single fault conditions**, **instructed persons** should not be exposed to parts comprising energy sources capable of causing injury.

0.2.4 Skilled person

Skilled person is a term applied to persons who have training or experience in the equipment technology, particularly in knowing the various energies and energy magnitudes used in the equipment. **Skilled persons** are expected to use their training and experience to recognize energy sources capable of causing pain or injury and to take action for protection from injury from those energies. **Skilled persons** should also be protected against unintentional contact or exposure to energy sources capable of causing injury.

0.3 Model for pain and injury

An energy source that causes pain or injury does so through the transfer of some form of energy to or from a body part.

This concept is represented by a three-block model (see Figure 1).

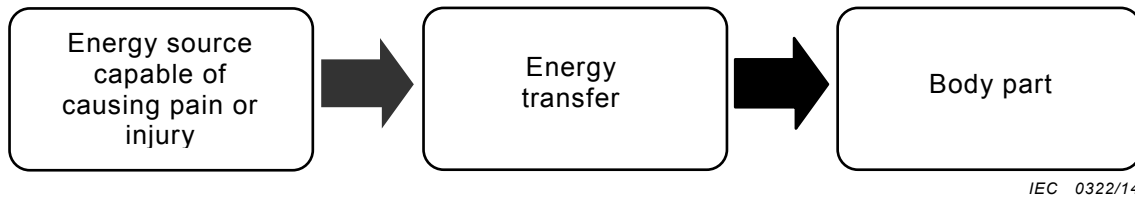

Figure 1 – Three block model for pain and injury

This safety standard specifies three classes of energy sources defined by magnitudes and durations of source parameters relative to either the body or to **combustible material** responses to those energy sources. Each energy class (see 4.2) is a function of the body part or the **combustible material** susceptibility to that energy magnitude (see Table 1).

Table 1 – Response to energy class

Energy source	Effect on the body	Effect on combustible materials
Class 1	Not painful, but may be detectable	Ignition not likely
Class 2	Painful, but not an injury	Ignition possible, but limited growth and spread of fire
Class 3	Injury	Ignition likely, rapid growth and spread of fire

The energy threshold for pain or injury is not constant throughout the population. For example, for some energy sources, the threshold is a function of body mass; the lower the mass, the lower the threshold, and vice-versa. Other body variables include age, state of health, state of emotions, effect of drugs, skin characteristics, etc. Furthermore, even where outward appearances otherwise appear equal, individuals differ in their thresholds of susceptibility to the same energy source.

The effect of duration of energy transfer is a function of the specific energy form. For example, pain or injury from thermal energy can be very short (1 s) for high skin temperature, or very long (several hours) for low skin temperature.

Furthermore, the pain or injury may occur some considerable time after the transfer of energy to a body part. For example, pain or injury from some chemical or physiological reaction may not be manifested for days, weeks, months, or years.

0.4 Energy sources

Energy sources are addressed by this standard, together with the pain or injury that results from a transfer of that energy to the body, and the likelihood of property damage that results from fire escaping the equipment.

An electrical product is connected to an electrical energy source (for example, the **mains**), an external power supply, or a **battery**. An electrical product uses the electrical energy to perform its intended functions.

In the process of using electrical energy, the product transforms the electrical energy into other forms of energy (for example, thermal energy, kinetic energy, optical energy, audio energy, electromagnetic energy, etc.). Some energy transformations may be a deliberate part of the product function (for example, moving parts of a printer, images on a visual display unit, sound from a speaker, etc.). Some energy transformations may be a by-product of the product function (for example, heat dissipated by functional circuits, x-radiation from a cathode-ray tube, etc.).

Some products may use energy sources that are non-electrical energy sources such as **batteries**, moving parts, or chemicals, etc. The energy in these other sources may be transferred to or from a body part, or may be transformed into other energy forms (for example, a **battery** transforms chemical energy into electrical energy, or a moving body part transfers its kinetic energy to a sharp edge).

Examples of the types of energy forms and the associated injuries and property damage addressed in this standard are in Table 2.

Table 2 – Examples of body response or property damage related to energy sources

Forms of energy	Examples of body response or property damage	Clause
Electrical energy (for example, energized conductive parts)	Pain, fibrillation, cardiac arrest, respiratory arrest, skin burn, or internal organ burn	5
Thermal energy (for example, electrical ignition and spread of fire)	Electrically-caused fire leading to burn-related pain or injury, or property damage	6
Chemical reaction (for example, electrolyte, poison)	Skin damage, organ damage, or poisoning	7
Kinetic energy (for example, moving parts of equipment, or a moving body part against an equipment part)	Laceration, puncture, abrasion, contusion, crush, amputation, or loss of a limb, eye, ear, etc.	8
Thermal energy (for example, hot accessible parts)	Skin burn	9
Radiated energy (for example, electromagnetic energy, optical energy, acoustic energy)	Loss of sight, skin burn, or loss of hearing	10

0.5 Safeguards

0.5.1 General

Many products necessarily use energy capable of causing pain or injury. Product design cannot eliminate such energy use. Consequently, such products should use a scheme that reduces the likelihood of such energy being transferred to a body part. The scheme that reduces the likelihood of energy transfer to a body part is a **safeguard** (see Figure 2).



IEC 0323/14

Figure 2 – Three block model for safety

A **safeguard** is a device or scheme or system that

- is interposed between an energy source capable of causing pain or injury and a body part, and
- reduces the likelihood of transfer of energy capable of causing pain or injury to a body part.

NOTE **Safeguard** mechanisms against transfer of energy capable of causing pain or injury include:

- attenuating the energy (reduces the value of the energy); or
- impeding the energy (slows the rate of energy transfer); or
- diverting the energy (changes the energy direction); or
- disconnecting, interrupting, or disabling the energy source; or
- enveloping the energy source (reduces the likelihood of the energy from escaping); or
- interposing a barrier between a body part and the energy source.

A **safeguard** can be applied to the equipment, to the local installation, to a person or can be a learned or directed behaviour (for example, resulting from an **instructional safeguard**) intended to reduce the likelihood of transfer of energy capable of causing pain or injury. A **safeguard** may be a single element or may be a set of elements.

Generally, the order of preference for providing **safeguards** is:

- **equipment safeguards** are always useful, since they do not require any knowledge or actions by persons coming into contact with the equipment;
- **installation safeguards** are useful when a safety characteristic can only be provided after installation (for example, the equipment has to be bolted to the floor to provide stability);
- behavioural **safeguards** are useful when the equipment requires an energy source to be **accessible**.

In practice, **safeguard** selection accounts for the nature of the energy source, the intended user, the functional requirements of the equipment, and similar considerations.

0.5.2 Equipment safeguard

An **equipment safeguard** may be a **basic safeguard**, a **supplementary safeguard**, a **double safeguard**, or a **reinforced safeguard**.

0.5.3 Installation safeguard

Installation safeguards are not controlled by the equipment manufacturer, although in some cases, **installation safeguards** may be specified in the equipment installation instructions.

Generally, with respect to equipment, an **installation safeguard** is a **supplementary safeguard**.

NOTE For example, the protective earthing **supplementary safeguard** is located partly in the equipment and partly in the installation. The protective earthing **supplementary safeguard** is not effective until the equipment is connected to the installation.

Requirements for **installation safeguards** are not addressed in this standard. However, this standard does assume some **installation safeguards**, such as protective earthing, are in place and are effective.

0.5.4 Personal safeguard

A **personal safeguard** may be a **basic safeguard**, a **supplementary safeguard**, or a **reinforced safeguard**.

Requirements for **personal safeguards** are not addressed in this standard. However, this standard does assume that **personal safeguards** are available for use as specified by the manufacturer.

0.5.5 Behavioural safeguards

0.5.5.1 Introduction to behavioural safeguards

In the absence of an equipment, installation, or **personal safeguard**, a person may use a specific behaviour as a **safeguard** to avoid energy transfer and consequent injury. A behavioural **safeguard** is a voluntary or instructed behaviour intended to reduce the likelihood of transfer of energy to a body part.

Three kinds of behavioural **safeguards** are specified in this standard. Each kind of behavioural **safeguard** is associated with a specific kind of person. An **instructional safeguard** is usually addressed to an **ordinary person**, but may also be addressed to an **instructed person** or a **skilled person**. A **precautionary safeguard** is used by an **instructed person**. A **skill safeguard** is used by a **skilled person**.

0.5.5.2 Instructional safeguard

An **instructional safeguard** is a means of providing information, describing the existence and location of an energy source capable of causing pain or injury, and is intended to invoke a specific behaviour on the part of a person to reduce the likelihood of transfer of energy to a body part (see Annex F).

An **instructional safeguard** may be a visual indicator (symbols or words or both) or an audible message, as applicable to the expected use of the product.

When accessing locations where the equipment needs to be energized to perform a service activity, an **instructional safeguard** may be considered acceptable protection to bypass an **equipment safeguard** such that the person is made aware of how to avoid contact with a class 2 or class 3 energy source.

If **equipment safeguards** would interfere with or prohibit the equipment function, an **instructional safeguard** may replace an **equipment safeguard**.

If exposure to an energy source capable of causing pain or injury is essential to the correct functioning of equipment, an **instructional safeguard** may be used to ensure protection of persons instead of another **safeguard**. Consideration should be given as to whether the **instructional safeguard** should require the use of a **personal safeguard**.

Provision of an **instructional safeguard** does not result in an **ordinary person** becoming an **instructed person** (see 0.5.5.3).

0.5.5.3 Precautionary safeguard (used by an instructed person)

A **precautionary safeguard** is the training and experience or supervision of an **instructed person** by a **skilled person** to use precautions to protect the **instructed person** against class 2 energy sources. **Precautionary safeguards** are not specifically prescribed in this standard but are assumed to be effective when the term **instructed person** is used.

During equipment servicing, an **instructed person** may need to remove or defeat an **equipment safeguard**. In this case, an **instructed person** is expected to then apply precaution as a **safeguard** to avoid injury.

0.5.5.4 Skill safeguard (used by a skilled person)

A **skill safeguard** is the education, training, knowledge and experience of the **skilled person** that is used to protect the **skilled person** against class 2 or class 3 energy sources. **Skill safeguards** are not specifically prescribed in this standard but are assumed to be effective when the term **skilled person** is used.

During equipment servicing, a **skilled person** may need to remove or defeat an **equipment safeguard**. In this case, a **skilled person** is expected to then apply skill as a **safeguard** to avoid injury.

0.5.6 Safeguards during ordinary or instructed person service conditions

During **ordinary person** or **instructed person** service conditions, **safeguards** for such persons may be necessary. Such **safeguards** can be **equipment safeguards**, **personal safeguards**, or **instructional safeguards**.

0.5.7 Equipment safeguards during skilled person service conditions

During **skilled person** service conditions, **equipment safeguards** should be provided to protect against the effects of a body's involuntary reaction (for example, startle) that might cause unintentional contact with a class 3 energy source located outside the view of the **skilled person**.

NOTE This **safeguard** typically applies in large equipment, where the **skilled person** needs to partially or wholly enter between two or more class 3 energy source locations while servicing.

0.5.8 Examples of safeguard characteristics

Table 3 lists some examples of **safeguard** characteristics.

Table 3 – Examples of safeguard characteristics

Safeguard	Basic safeguard	Supplementary safeguard	Reinforced safeguard
Equipment safeguard: a physical part of an equipment	Effective under normal operating conditions	Effective in the event of failure of the basic safeguard	Effective under normal operating conditions and in the event of a single fault condition elsewhere in the equipment
	Example: basic insulation	Example: supplementary insulation	Example: reinforced insulation
	Example: normal temperatures below ignition temperatures	Example: fire enclosure	Not applicable
Installation safeguard: a physical part of a man-made installation	Effective under normal operating conditions	Effective in the event of failure of an equipment basic safeguard	Effective under normal operating conditions and in the event of a single fault condition elsewhere in the equipment
	Example: wire size	Example: overcurrent protective device	Example: socket outlet
Personal safeguard: a physical device worn on the body	In the absence of any equipment safeguard , effective under normal operating conditions	Effective in the event of failure of an equipment basic safeguard	In the absence of any equipment safeguard , effective under normal operating conditions and in the event of a single fault condition elsewhere in the equipment
	Example: gloves	Example: insulating floor mat	Example: electrically-insulated glove for handling live conductors
Instructional safeguard: a voluntary or instructed behaviour intended to reduce the likelihood of transfer of energy to a body part	In the absence of any equipment safeguard , effective under normal operating conditions	Effective in the event of failure of an equipment basic safeguard	Only effective on an exceptional basis, when providing all appropriate safeguards would prevent the intended functioning of the equipment
	Example: instructional safeguard to disconnect telecommunication cable before opening the cover	Example: after opening a door, an instructional safeguard against hot parts	Example: instructional safeguard of hot parts in an office photocopier, or a continuous roll paper cutter on a commercial printer

0.6 Electrically-caused pain or injury (electric shock)

0.6.1 Models for electrically-caused pain or injury

Electrically-caused pain or injury may occur when electrical energy capable of causing pain or injury is transferred to a body part (see Figure 3).

Electrical energy transfer occurs when there are two or more electrical contacts to the body:

- the first electrical contact is between a body part and a conductive part of the equipment;
- the second electrical contact is between another body part; and
 - earth, or
 - another conductive part of the equipment.

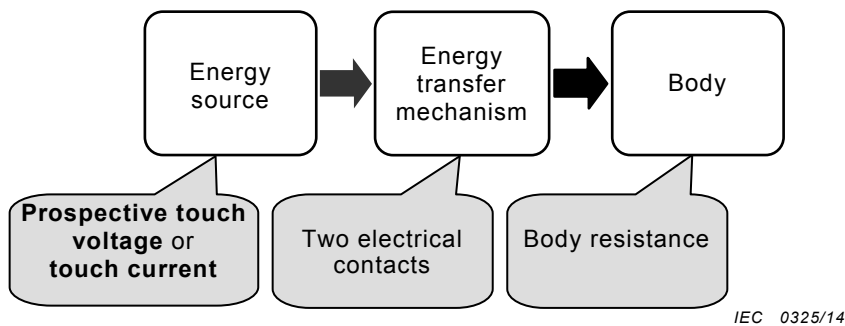
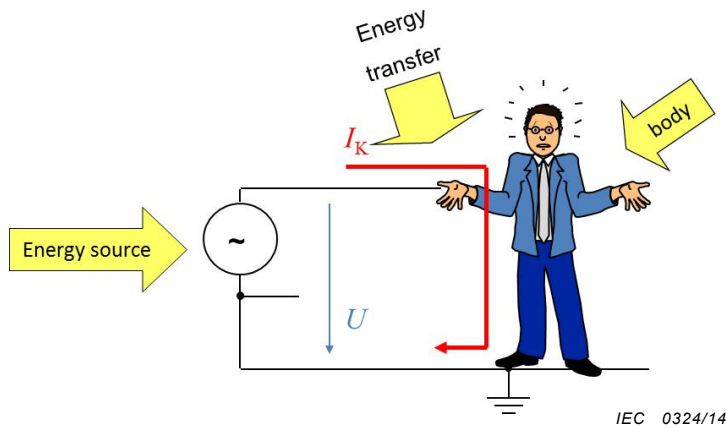

Figure 3 – Schematic and model for electrically-caused pain or injury

Depending on the magnitude, duration, wave shape, and frequency of the current, the effect to the human body varies from undetectable to detectable to painful to injurious.

0.6.2 Models for protection against electrically-caused pain or injury

Protection against electrically-caused pain or injury requires that one or more **safeguards** be interposed between an electrical energy source capable of causing pain or injury and a body part (see Figure 4).

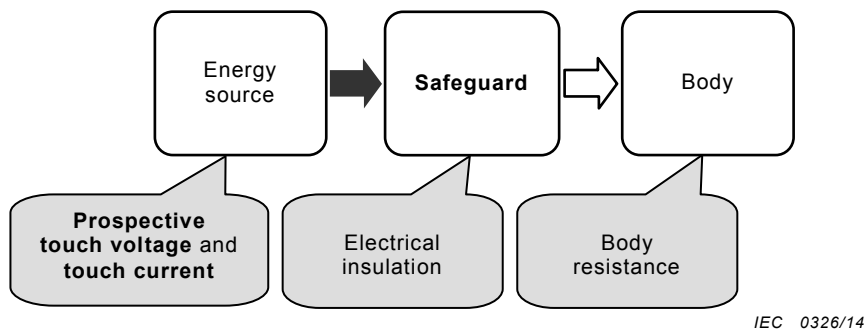

Figure 4 – Model for protection against electrically-caused pain or injury

Protection against electrically-caused pain is provided under **normal operating conditions** and **abnormal operating conditions**. Such protection requires that, under **normal operating conditions** and **abnormal operating conditions**, a **basic safeguard** be interposed between an electrical energy source capable of causing pain and an **ordinary person**.

The most common **basic safeguard** against an electrical energy source capable of causing pain is electrical insulation (also known as **basic insulation**) interposed between the energy source and a body part.

Protection against electrically-caused injury is provided under **normal operating conditions**, **abnormal operating conditions**, and **single fault conditions**. Such protection requires that, under **normal operating conditions** and **abnormal operating conditions**, both a **basic safeguard** and a **supplementary safeguard** be interposed between an electrical energy source capable of causing injury and an **ordinary person** (see 4.3.2.4), or an **instructed person** (see 4.3.3.3). In the event of a failure of either **safeguard**, the other **safeguard** becomes effective. The **supplementary safeguard** against an electrical energy source capable of causing injury is placed between the **basic safeguard** and a body part. A **supplementary safeguard** may be additional electrical insulation (**supplementary insulation**) or a protectively earthed conductive barrier or other construction that performs the same function.

The most common **safeguard** against an electrical energy source capable of causing injury is electrical insulation (also known as **double insulation** or **reinforced insulation**) placed between the energy source and a body part.

Likewise, a **reinforced safeguard** may be placed between an electrical energy source capable of causing injury and a body part.

0.7 Electrically-caused fire

0.7.1 Models for electrically-caused fire

Electrically-caused fire is due to conversion of electrical energy to thermal energy (see Figure 5), where the thermal energy heats a fuel material followed by ignition and combustion.

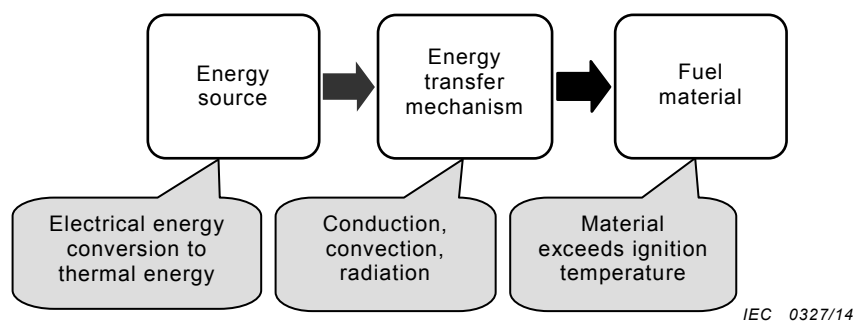

Figure 5 – Model for electrically-caused fire

Electrical energy is converted to thermal energy either in a resistance or in an arc and is transferred to a fuel material by conduction, convection, or radiation. As the fuel material heats, it chemically decomposes into gases, liquids and solids. When the gas is at its ignition temperature, the gas can be ignited by an ignition source. When the gas is at its spontaneous ignition temperature, the gas ignites by itself. Both result in fire.

0.7.2 Models for protection against electrically-caused fire

The **basic safeguard** against electrically-caused fire (see Figure 6) is that the temperature of a material, under **normal operating conditions** and **abnormal operating conditions**, does not cause the material to ignite.

The **supplementary safeguard** against electrically-caused fire reduces the likelihood of ignition or, in the case of ignition, reduces the likelihood of spread of fire.

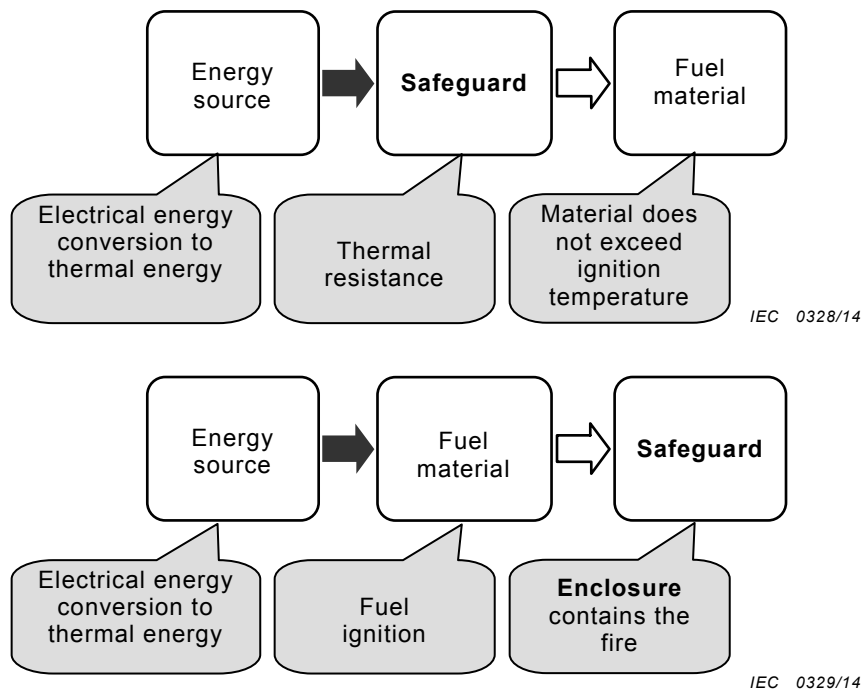

Figure 6 – Models for protection against fire

0.8 Injury caused by hazardous substances

Injury caused by **hazardous substances** is due to a chemical reaction with a body part. The extent of injury by a given substance depends on both the magnitude and duration of exposure and on the body part susceptibility to that substance.

The **basic safeguard** against injury caused by **hazardous substances** is containment of the material.

Supplementary safeguards against injury caused by **hazardous substances** may include:

- a second container or a spill-resistant container;
- containment trays;
- tamper-proof screws to prevent unauthorized access;
- **instructional safeguards.**

National and regional regulations govern the use of and exposure to **hazardous substances** used in equipment. These regulations do not enable a practical classification of **hazardous substances** in the manner in which other energy sources are classified in this standard. Therefore, energy source classifications are not applied in Clause 7.

0.9 Mechanically-caused injury

Mechanically-caused injury is due to kinetic energy transfer to a body part when a collision occurs between a body part and an equipment part. The kinetic energy is a function of the relative motion between a body part and **accessible** parts of the equipment, including parts ejected from the equipment that collide with a body part.

Examples of kinetic energy sources are:

- body motion relative to sharp edges and corners;
- part motion due to rotating or other moving parts, including pinch points;
- part motion due to loosening, exploding, or imploding parts;
- equipment motion due to instability;
- equipment motion due to wall, ceiling, or rack mounting means failure;
- equipment motion due to handle failure;
- part motion due to an exploding **battery**;
- equipment motion due to cart or stand instability or failure.

The **basic safeguard** against mechanically-caused injury is a function of the specific energy source. **Basic safeguards** may include:

- rounded edges and corners;
- an **enclosure** to prevent a moving part from being **accessible**;
- an **enclosure** to prevent expelling a moving part;
- a **safety interlock** to control access to an otherwise moving part;
- means to stop the motion of a moving part;
- means to stabilize the equipment;
- robust handles;
- robust mounting means;
- means to contain parts expelled during **explosion** or implosion.

The **supplementary safeguard** against mechanically-caused injury is a function of the specific energy source. **Supplementary safeguards** may include:

- **instructional safeguards**;
- instructions and training;
- additional **enclosures** or barriers;
- **safety interlocks**.

The **reinforced safeguard** against mechanically-caused injury is a function of the specific energy source. **Reinforced safeguards** may include:

- extra thick glass on the front of a CRT;
- rack slide-rails and means of support;
- **safety interlock**.

0.10 Thermally-caused injury (skin burn)

0.10.1 Models for thermally-caused injury

Thermally-caused injury may occur when thermal energy capable of causing injury is transferred to a body part (see Figure 7).

Thermal energy transfer occurs when a body touches a hot equipment part. The extent of injury depends on the temperature difference, the thermal mass of the object, rate of thermal energy transfer to the skin, and duration of contact.

The requirements in this standard only address **safeguards** against thermal energy transfer by conduction. This standard does not address **safeguards** against thermal energy transfer by convection or radiation.



IEC 0330/14

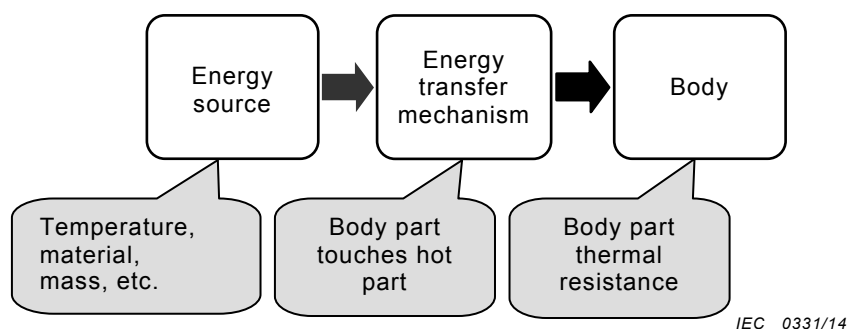

IEC 0331/14

Figure 7 – Schematic and model for thermally-caused injury

Depending on the temperature, contact duration, material properties, and mass of the material, the perception of the human body varies from warmth to heat that may result in pain or injury (burn).

0.10.2 Models for protection against thermally-caused pain or injury

Protection against thermally-caused pain or injury requires that one or more **safeguards** be interposed between a thermal energy source capable of causing pain or injury and an **ordinary person** (see Figure 8).

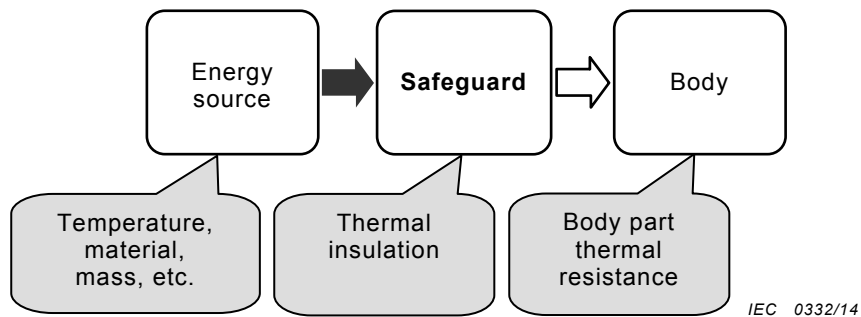

Figure 8 – Model for protection against thermally-caused injury

Protection against thermally-caused pain is required under **normal operating conditions** and **abnormal operating conditions**. Such protection requires that a **basic safeguard** be interposed between a thermal energy source capable of causing pain and an **ordinary person**.

Protection against thermally-caused injury is required under **normal operating conditions**, **abnormal operating conditions** and **single fault conditions**. Such protection requires that a **basic safeguard** and a **supplementary safeguard** be interposed between a thermal energy source capable of causing injury and an **ordinary person**.

The **basic safeguard** against a thermal energy source capable of causing pain or injury is thermal insulation placed between the energy source and a body part. In some cases, a **basic safeguard** against a thermal energy source capable of causing pain or injury may be an **instructional safeguard** identifying the hot parts and how to reduce the likelihood of injury. In some cases, a **basic safeguard** reduces the likelihood of a non-injurious thermal energy source from becoming a thermal energy source capable of causing pain or injury.

Examples of such **basic safeguards** are:

- control of electrical energy being converted to thermal energy (for example, a **thermostat**); and
- heat sinking, etc.

The **supplementary safeguard** against a thermal energy source capable of causing injury is thermal insulation placed between the energy source and a body part. In some cases, a **supplementary safeguard** against a thermal energy source capable of causing pain or injury may be an **instructional safeguard** identifying the hot parts and how to reduce the likelihood of injury.

0.11 Radiation-caused injury

Radiation-caused injury within the scope of this standard is generally attributed to one of the following energy transfer mechanisms:

- heating of a body organ caused by exposure to non-ionising radiation, such as the highly localised energy of a laser impinging on the retina, or heating a larger volume such as the energy from a high frequency wireless, electromagnetic fields, or high frequency transmitter; or
- auditory injury caused by over stimulation of the ear by excessive peaks or sustained loud sound, leading to physical or nerve damage.

Radiated energy is transferred by impingement of wave emission upon a body part.

The **basic safeguard** against radiation-caused injury is containment of the energy within an **enclosure** that is opaque to the radiated energy.

There are several **supplementary safeguards** against radiation-caused injury. The **supplementary safeguards** may include **safety interlocks** to disconnect power to the generator, tamper-proof screws to prevent unauthorized access, etc.

The **basic safeguard** against auditory injury is to limit the acoustic output of personal music players and their associated headphones and earphones.

Examples of **supplementary safeguards** against auditory pain and injury are the provision of warnings and information advising the user how to use the equipment correctly.

AUDIO/VIDEO, INFORMATION AND COMMUNICATION TECHNOLOGY EQUIPMENT –

Part 1: Safety requirements

1 Scope

This part of IEC 62368 is applicable to the safety of electrical and electronic equipment within the field of audio, video, information and communication technology, and business and office machines with a **rated voltage** not exceeding 600 V. This standard does not include requirements for performance or functional characteristics of equipment.

NOTE 1 Examples of equipment within the scope of this standard are given in Annex A.

NOTE 2 A **rated voltage** of 600 V is considered to include equipment rated 400/690 V.

This part of IEC 62368 is also applicable to:

- components and subassemblies intended for incorporation in this equipment. Such components and subassemblies need not comply with every requirement of the standard, provided that the complete equipment, incorporating such components and subassemblies, does comply;
- external power supply units intended to supply other equipment within the scope of this part of IEC 62368;
- accessories intended to be used with equipment within the scope of this part of IEC 62368.

This part of IEC 62368 does not apply to power supply systems which are not an integral part of the equipment, such as motor-generator sets, **battery** backup systems and distribution transformers.

This part of IEC 62328 specifies **safeguards** for **ordinary persons**, **instructed persons**, and **skilled persons**. Additional requirements may apply for equipment that is clearly designed or intended for use by children or specifically attractive to children.

NOTE 3 In Australia, the work conducted by an **instructed person** or a **skilled person** may require formal licensing from regulatory authorities.

This standard assumes an altitude of 2 000 m unless specified otherwise by the manufacturer.

This part of IEC 62368 does not apply to equipment to be used in wet areas. Additional requirements may apply.

Additional requirements for equipment intended for outdoor installation are given in IEC 60950-22.

This part of IEC 62368 does not address:

- manufacturing processes except safety testing;
- injurious effects of gases released by thermal decomposition or combustion;
- disposal processes;
- effects of transport (other than as specified in this standard);
- effects of storage of materials, components, or the equipment itself;

- the likelihood of injury from particulate radiation such as alpha particles and beta particles;
- the likelihood of thermal injury due to radiated or convected thermal energy;
- the likelihood of injury due to flammable liquids;
- the use of the equipment in oxygen-enriched or **explosive** atmospheres;
- exposure to chemicals other than as specified in Clause 7;
- electrostatic discharge events;
- environmental aspects;
- requirements for functional safety.

NOTE 4 For specific functional and software safety requirements of electronic safety-related systems (for example, protective electronic circuits), see IEC 61508-1.

2 Normative references

The following documents, in whole or in part, are normatively referenced in this document and are indispensable for its application. For dated references, only the edition cited applies. For undated references, the latest edition of the referenced document (including any amendments) applies.

IEC 60027-1, *Letter symbols to be used in electrical technology – Part 1: General*

IEC 60065, *Audio, video and similar electronic apparatus – Safety requirements*

IEC 60068-2-6, *Environmental testing – Part 2-6: Tests – Test Fc: Vibration (sinusoidal)*

IEC 60068-2-78, *Environmental testing – Part 2-78: Tests – Test Cab: Damp heat, steady state*

IEC/TR 60083, *Plugs and socket-outlets for domestic and similar general use standardized in member countries of IEC*

IEC 60085, *Electrical insulation – Thermal evaluation and designation*

IEC 60086-4, *Primary batteries – Part 4: Safety of lithium batteries*

IEC 60086-5, *Primary batteries – Part 5: Safety of batteries with aqueous electrolyte*

IEC 60107-1:1997, *Methods of measurement on receivers for television broadcast transmissions – Part 1: General considerations – Measurements at radio and video frequencies*

IEC 60112, *Method for the determination of the proof and the comparative tracking indices of solid insulating materials*

IEC 60127 (all parts), *Miniature fuses*

IEC 60227-1, *Polyvinyl chloride insulated cables of rated voltages up to and including 450/750 V – Part 1: General requirements*

IEC 60227-2:2003, *Polyvinyl chloride insulated cables of rated voltages up to and including 450/750 V – Part 2: Test methods*

IEC 60245-1, *Rubber insulated cables – Rated voltages up to and including 450/750 V – Part 1: General requirements*

IEC 60309 (all parts), *Plugs, socket-outlets and couplers for industrial purposes*

IEC 60317 (all parts), *Specifications for particular types of winding wires*

IEC 60317-43, *Specifications for particular types of winding wires – Part 43: Aromatic polyimide tape wrapped round copper wire, class 240*

IEC 60320 (all parts), *Appliance couplers for household and similar general purposes*

IEC 60320-1, *Appliance couplers for household and similar general purposes – Part 1: General requirements*

IEC 60320-2-2, *Appliance couplers for household and similar general purposes – Part 2-2: Interconnection couplers for household and similar equipment*

IEC 60332-1-2, *Tests on electric and optical fibre cables under fire conditions – Part 1-2: Test for vertical flame propagation for a single insulated wire or cable – Procedure for 1 kW pre-mixed flame*

IEC 60332-1-3, *Tests on electric and optical fibre cables under fire conditions – Part 1-3: Test for vertical flame propagation for a single insulated wire or cable – Procedure for determination of flaming droplets/particles*

IEC 60332-2-2, *Tests on electric and optical fibre cables under fire conditions – Part 2-2: Test for vertical flame propagation for a single small insulated wire or cable – Procedure for diffusion flame*

IEC 60384-14:2005, *Fixed capacitors for use in electronic equipment – Part 14: Sectional specification: Fixed capacitors for electromagnetic interference suppression and connection to the supply mains*

IEC 60417, *Graphical symbols for use on equipment*, available from: <<http://www.graphical-symbols.info/equipment>>

IEC 60529, *Degrees of protection provided by enclosures (IP Code)*

IEC 60664-1:2007, *Insulation coordination for equipment within low-voltage systems – Part 1: Principles, requirements and tests*

IEC 60664-3, *Insulation coordination for equipment within low-voltage systems – Part 3: Use of coating, potting or moulding for protection against pollution*

IEC 60691:2002, *Thermal-links – Requirements and application guide*

IEC 60695-10-2, *Fire hazard testing – Part 10-2: Abnormal heat – Ball pressure test*

IEC 60695-10-3, *Fire hazard testing – Part 10-3: Abnormal heat – Mould stress relief distortion test*

IEC 60695-11-5:2004, *Fire hazard testing – Part 11-5: Test flames – Needle-flame test method – Apparatus, confirmatory test arrangement and guidance*

IEC 60695-11-10, *Fire hazard testing – Part 11-10: Test flames – 50 W horizontal and vertical flame test methods*

IEC 60695-11-20:1999, *Fire hazard testing – Part 11-20: Test flames – 500 W flame test methods*

IEC/TS 60695-11-21, *Fire hazard testing – Part 11-21: Test flames – 500 W vertical flame test method for tubular polymeric materials*

IEC 60728-11:2005, *Cable networks for television signals, sound signals and interactive services – Part 11: Safety*

IEC 60730 (all parts), *Automatic electrical controls for household and similar use*

IEC 60730-1:2010, *Automatic electrical controls for household and similar use – Part 1: General requirements*

IEC 60738-1:2009, *Thermistors – Directly heated positive temperature coefficient – Part 1: Generic specification*

IEC 60747-5-5:2007, *Semiconductor devices – Discrete devices – Part 5-5: Optoelectronic devices – Photocouplers*

IEC 60825-1:2007, *Safety of laser products – Part 1: Equipment classification and requirements*

IEC 60825-2:2004, *Safety of laser products – Part 2: Safety of optical fibre communication systems (OFCS)*

IEC 60825-12, *Safety of laser products – Part 12: Safety of free space optical communication systems used for transmission of information*

IEC 60851-3:2009, *Winding wires – Test methods – Part 3: Mechanical properties*

IEC 60851-5:2008, *Winding wires – Test methods – Part 5: Electrical properties*

IEC 60851-6:1996, *Winding wires – Test methods – Part 6: Thermal properties*

IEC 60896-11, *Stationary lead-acid batteries – Part 11: Vented types – General requirements and methods of tests*

IEC 60896-21:2004, *Stationary lead-acid batteries – Part 21: Valve regulated types – Methods of test*

IEC 60896-22, *Stationary lead-acid batteries – Part 22: Valve regulated types – Requirements*

IEC 60906-1, *IEC system of plugs and socket-outlets for household and similar purposes – Part 1: Plugs and socket-outlets 16 A 250 V a.c.*

IEC 60906-2, *IEC system of plugs and socket-outlets for household and similar purposes – Part 2: Plugs and socket-outlets 15 A 125 V a.c.*

IEC 60947-1, *Low-voltage switchgear and controlgear – Part 1: General rules*

IEC 60950-1:2005, *Information technology equipment – Safety – Part 1: General requirements*

IEC 60950-22:2005, *Information technology equipment – Safety – Part 22: Equipment to be installed outdoors*

IEC 60950-23, *Information technology equipment – Safety – Part 23: Large data storage equipment*

IEC 60990:1999, *Methods of measurement of touch current and protective conductor current*

IEC 60998-1, *Connecting devices for low-voltage circuits for household and similar purposes – Part 1: General requirements*

IEC 60999-1, *Connecting devices – Electrical copper conductors – Safety requirements for screw-type and screwless-type clamping units – Part 1: General requirements and particular requirements for clamping units for conductors from 0,2 mm² up to 35 mm² (included)*

IEC 60999-2, *Connecting devices – Electrical copper conductors – Safety requirements for screw-type and screwless-type clamping units – Part 2: Particular requirements for clamping units for conductors above 35 mm² up to 300 mm² (included)*

IEC 61051-1, *Varistors for use in electronic equipment – Part 1: Generic specification*

IEC 61051-2:1991, *Varistors for use in electronic equipment – Part 2: Sectional specification for surge suppression varistors*

Amendment 1:2009

IEC 61056-1, *General purpose lead-acid batteries (valve-regulated types) – Part 1: General requirements, functional characteristics – Methods of test*

IEC 61056-2, *General purpose lead-acid batteries (valve-regulated types) – Part 2: Dimensions, terminals and marking*

IEC 61058-1:2008, *Switches for appliances – Part 1: General requirements*

IEC 61140:2001, *Protection against electric shock – Common aspects for installation and equipment*

IEC/TS 61201:2007, *Use of conventional touch voltage limits – Application guide*

IEC 61204-7, *Low-voltage power supplies, d.c. output – Part 7: Safety requirements*

IEC 61293, *Marking of electrical equipment with ratings related to electrical supply – Safety requirements*

IEC 61427, *Secondary cells and batteries for photovoltaic energy systems (PVES) – General requirements and methods of test*

IEC/TS 61430, *Secondary cells and batteries – Test methods for checking the performance of devices designed for reducing explosion hazards – Lead-acid starter batteries*

IEC 61434, *Secondary cells and batteries containing alkaline or other non-acid electrolytes – Guide to designation of current in alkaline secondary cell and battery standards*

IEC 61558-1:2005, *Safety of power transformers, power supplies, reactors and similar products – Part 1: General requirements and tests*

IEC 61558-2-16, *Safety of transformers, reactors, power supply units and similar products for voltages up to 1 100 V – Part 2-16: Particular requirements and tests for switch mode power supply units and transformers for switch mode power supply units*¹

IEC 61643-11, *Low-voltage surge protective devices – Part 11: Surge protective devices connected to low-voltage power systems – Requirements and test methods*

IEC 61810-1:2008, *Electromechanical elementary relays – Part 1: General requirements*

IEC 61959, *Secondary cells and batteries containing alkaline or other non-acid electrolytes – Mechanical tests for sealed portable secondary cells and batteries*

IEC 61965:2003, *Mechanical safety of cathode ray tubes*

IEC 61984, *Connectors – Safety requirements and tests*

IEC 62133, *Secondary cells and batteries containing alkaline or other non-acid electrolytes – Safety requirements for portable sealed secondary cells, and for batteries made from them, for use in portable applications*

IEC 62281, *Safety of primary and secondary lithium cells and batteries during transport*

IEC 62471:2006, *Photobiological safety of lamps and lamp systems*

IEC/TR 62471-2, *Photobiological safety of lamps and lamp systems – Part 2: Guidance on manufacturing requirements relating to non-laser optical radiation safety*

IEC 62485-2, *Safety requirements for secondary batteries and battery installations – Part 2: Stationary batteries*²

ISO 178, *Plastics – Determination of flexural properties*

ISO 179-1, *Plastics – Determination of Charpy impact properties – Part 1: Non-instrumented impact test*

ISO 180, *Plastics – Determination of Izod impact strength*

ISO 306, *Plastics – Thermoplastic materials – Determination of Vicat softening temperature (VST)*

ISO 527 (all parts), *Plastics – Determination of tensile properties*

ISO 871, *Plastics – Determination of ignition temperature using a hot-air furnace*

ISO 3864 (all parts), *Graphical symbols – Safety colours and safety signs*

ISO 3864-2, *Graphical symbols – Safety colours and safety signs – Part 2: Design principles for product safety labels*

ISO 4892-1, *Plastics – Methods of exposure to laboratory light sources – Part 1: General guidance*

¹ To be published.

² To be published.

ISO 4892-2:2006, *Plastics – Methods of exposure to laboratory light sources – Part 2: Xenon-arc lamps*

ISO 4892-4, *Plastics – Methods of exposure to laboratory light sources – Part 4: Open-flame carbon-arc lamps*

ISO 7000, *Graphical symbols for use on equipment – Index and synopsis*, available from: <http://www.graphical-symbols.info/equipment>

ISO 7010, *Graphical symbols – Safety colours and safety signs – Safety signs used in workplaces and public areas*

ISO 8256, *Plastics – Determination of tensile-impact strength*

ISO 9772, *Cellular plastics – Determination of horizontal burning characteristics of small specimens subjected to a small flame*

ISO 9773, *Plastics – Determination of burning behaviour of thin flexible vertical specimens in contact with a small-flame ignition source*

EN 50332-1, *Sound system equipment: Headphones and earphones associated with portable audio equipment – Maximum sound pressure level measurement methodology and limit considerations – Part 1: General method for "one package equipment"*

EN 50332-2, *Sound system equipment: Headphones and earphones associated with portable audio equipment – Maximum sound pressure level measurement methodology and limit considerations – Part 2: Matching of sets with headphones if either or both are offered separately*

3 Terms, definitions and abbreviations

3.1 Energy source abbreviations

Abbreviation	Description	
ES	Electrical energy source	see 5.2
ES1	Electrical energy source class 1	
ES2	Electrical energy source class 2	
ES3	Electrical energy source class 3	
MS	Mechanical energy source	see 8.2
MS1	Mechanical energy source class 1	
MS2	Mechanical energy source class 2	
MS3	Mechanical energy source class 3	
PS	Power source	see 6.2
PS1	Power source class 1	
PS2	Power source class 2	
PS3	Power source class 3	
RS	Radiation energy source	see 10.2
RS1	Radiation energy source class 1	
RS2	Radiation energy source class 2	
RS3	Radiation energy source class 3	
TS	Thermal energy source	see 9.2
TS1	Thermal energy source class 1	
TS2	Thermal energy source class 2	
TS3	Thermal energy source class 3	

3.2 Other abbreviations

Abbreviation	Description
CD	compact disk
CD ROM	compact disc read-only memory
CRT	cathode raytube
CTI	comparative tracking index
DVD	digital versatile disc
EIS	electrical insulation system
EUT	equipment under test
GDT	gas discharge tube
IC	integrated circuit
ICX	integrated circuit with X-capacitor function
LED	light emitting diode
LEL	lower explosion limit
LFC	liquid filled component
LPS	limited power source
MOV	metal oxide varistor
NiCd	nickel cadmium

Abbreviation	Description
PIS	potential ignition source
PPE	personal protective equipment
PTC	positive temperature coefficient
RC	resistor-capacitor
RG	risk group
Sb	antimony
SPD	surge protective device
SRME	slide rail mounted equipment
UPS	uninterruptible power supply
VDR	voltage dependent resistor
VRLA	valve regulated lead acid

3.3 Terms and definitions

For the purposes of this document the following terms and definitions apply. For the convenience of the user, the defined terms are listed below in alphabetical order indicating the number of the defined term.

Where the words "voltage" and "current" or their abbreviations are used, they are r.m.s. values unless otherwise specified.

5VA class material	3.3.4.2.1
5VB class material	3.3.4.2.2
abnormal operating condition	3.3.7.1
accessible	3.3.6.1
arcing PIS.....	3.3.9.2
basic insulation.....	3.3.5.1
basic safeguard	3.3.11.1
battery	3.3.17.1
cell	3.3.17.2
cheesecloth	3.3.6.2
class I equipment.....	3.3.15.1
class II construction	3.3.15.2
class II equipment.....	3.3.15.3
class III equipment.....	3.3.15.4
clearance.....	3.3.12.1
coin / button cell battery.....	3.3.17.3
combustible material	3.3.4.1
consumable material.....	3.3.16.1
creepage distance	3.3.12.2
d.c. voltage.....	3.3.14.1
direct plug-in equipment.....	3.3.3.1
disconnect device	3.3.6.3
double insulation.....	3.3.5.2
double safeguard	3.3.11.2
electrical enclosure	3.3.2.1
enclosure.....	3.3.2.2
equipment safeguard	3.3.11.3
explosion	3.3.16.2
explosive	3.3.16.3
external circuit.....	3.3.1.1
fire enclosure.....	3.3.2.3
functional earth	3.3.6.4
functional insulation.....	3.3.5.3
hand-held equipment	3.3.3.2
hazardous substance	3.3.16.4
HB40 class material	3.3.4.2.3

HB75 class material	3.3.4.2.4
HBF class foamed material	3.3.4.2.5
HF-1 class foamed material	3.3.4.2.6
HF-2 class foamed material	3.3.4.2.7
highest specified charging temperature	3.3.17.4
installation safeguard	3.3.11.4
instructed person	3.3.8.1
instructional safeguard	3.3.11.5
intermittent operation	3.3.7.2
lowest specified charging temperature	3.3.17.5
mains transient voltage	3.3.14.2
mains	3.3.1.2
material flammability class	3.3.4.2
maximum specified charging current	3.3.17.6
maximum specified charging voltage	3.3.17.7
mechanical enclosure	3.3.2.4
movable equipment	3.3.3.3
non-clipped output power	3.3.7.3
non-detachable power supply cord	3.3.6.5
normal operating condition	3.3.7.4
ordinary person	3.3.8.2
overload condition	3.3.7.5
peak response frequency	3.3.7.6
peak working voltage	3.3.14.3
permanently connected equipment	3.3.3.4
personal safeguard	3.3.11.6
pluggable, type A equipment	3.3.3.5
pluggable, type B equipment	3.3.3.6
pollution degree	3.3.6.6
potential ignition source (PIS)	3.3.9.1
precautionary safeguard	3.3.11.7
prospective touch voltage	3.3.14.4
protective bonding conductor	3.3.11.8
protective conductor current	3.3.14.5
protective conductor	3.3.11.9
protective current rating	3.3.10.6
protective earthing conductor	3.3.11.10
r.m.s. working voltage	3.3.14.7
rated current	3.3.10.1
rated frequency	3.3.10.2
rated load impedance	3.3.7.7
rated power	3.3.10.3
rated voltage range	3.3.10.5
rated voltage	3.3.10.4
reasonably foreseeable misuse	3.3.7.8
reinforced insulation	3.3.5.4
reinforced safeguard	3.3.11.11
required withstand voltage	3.3.14.6
resistive PIS	3.3.9.3
restricted access area	3.3.6.7
routine test	3.3.6.8
safeguard	3.3.11.12
safety interlock	3.3.11.13
sampling test	3.3.6.9
secondary lithium battery	3.3.17.8
short-time operation	3.3.7.9
single fault condition	3.3.7.10
skill safeguard	3.3.11.14
skilled person	3.3.8.3
solid insulation	3.3.5.5
stationary equipment	3.3.3.7
supplementary insulation	3.3.5.6

supplementary safeguard.....	3.3.11.15
temperature limiter.....	3.3.13.1
temporary overvoltage	3.3.14.8
thermal cut-off	3.3.13.2
thermostat	3.3.13.3
tool	3.3.6.10
touch current	3.3.6.11
transportable equipment	3.3.3.8
type test.....	3.3.6.12
V-0 class material	3.3.4.2.8
V-1 class material	3.3.4.2.9
V-2 class material	3.3.4.2.10
VTM-0 class material	3.3.4.2.11
VTM-1 class material	3.3.4.2.12
VTM-2 class material	3.3.4.2.13
working voltage.....	3.3.14.9
wrapping tissue.....	3.3.6.13

3.3.1 Circuit terms

3.3.1.1

external circuit

electrical circuit that is external to the equipment and is not **mains**

Note 1 to entry: An **external circuit** is classified as ES1, ES2 or ES3, and PS1, PS2, or PS3.

3.3.1.2

mains

a.c. or d.c. power distribution system (external to the equipment) that supplies operating power to the equipment and is PS3

Note 1 to entry: **Mains** include public or private utilities and, unless otherwise specified in this standard, equivalent sources such as motor-driven generators and uninterruptible power supplies.

3.3.2 Enclosure terms

3.3.2.1

electrical enclosure

enclosure intended as a **safeguard** against electrically-caused injury

[SOURCE: IEC 60050-195:1998, 195-06-13, modified – the term **safeguard** has been used]

3.3.2.2

enclosure

housing affording the type and degree of protection suitable for the intended application

[SOURCE: IEC 60050-195:1998, 195-02-35]

3.3.2.3

fire enclosure

enclosure intended as a **safeguard** against the spread of fire from within the **enclosure** to outside the **enclosure**

3.3.2.4

mechanical enclosure

enclosure intended as a **safeguard** against mechanically-caused pain and injury

3.3.3 Equipment terms

3.3.3.1

direct plug-in equipment

equipment in which the **mains** plug forms an integral part of the equipment **enclosure**

3.3.3.2

hand-held equipment

movable equipment, or a part of any kind of equipment, that is intended to be held in the hand during normal use

3.3.3.3

movable equipment

equipment that is either:

- 18 kg or less in mass and not fixed in place; or
- provided with wheels, casters, or other means to facilitate movement by an **ordinary person** as required to perform its intended use

3.3.3.4

permanently connected equipment

equipment that can only be electrically connected to or disconnected from the **mains** by the use of a **tool**

3.3.3.5

pluggable equipment type A

equipment that is intended for connection to the **mains** via a non-industrial plug and socket-outlet or via a non-industrial appliance coupler, or both

Note 1 to entry: Examples are plugs and socket-outlets covered by standards such as IEC/TR 60083 and IEC 60320-1.

3.3.3.6

pluggable equipment type B

equipment that is intended for connection to the **mains** via an industrial plug and socket-outlet or via an industrial appliance coupler, or both

Note 1 to entry: Examples are plugs and socket-outlets covered by standards such as IEC 60309-1.

3.3.3.7

stationary equipment

- fixed equipment, or
- **permanently connected equipment**, or
- equipment that, due to its physical characteristics, is normally not moved

Note 1 to entry: **Stationary equipment** is neither **movable equipment** nor **transportable equipment**.

3.3.3.8

transportable equipment

equipment that is intended to be routinely carried

Note 1 to entry: Examples include notebook computers, CD players and portable accessories, including their external power supplies.

3.3.4 Flammability terms

3.3.4.1

combustible material

organic material, capable of combustion

Note 1 to entry: All thermoplastic materials are considered capable of being combusted regardless of the **material flammability class**.

3.3.4.2

material flammability class

recognition of the burning behaviour of materials and their ability to extinguish if ignited

Note 1 to entry: Materials are classified when tested in accordance with IEC 60695-11-10, IEC 60695-11-20, ISO 9772 or ISO 9773.

3.3.4.2.1

5VA class material

material tested in the thinnest significant thickness used and classified 5VA according to IEC 60695-11-20

3.3.4.2.2

5VB class material

material tested in the thinnest significant thickness used and classified 5VB according to IEC 60695-11-20

3.3.4.2.3

HB40 class material

material tested in the thinnest significant thickness used and classified HB40 according to IEC 60695-11-10

3.3.4.2.4

HB75 class material

material tested in the thinnest significant thickness used and classified HB75 according to IEC 60695-11-10

3.3.4.2.5

HBF class foamed material

foamed material tested in the thinnest significant thickness used and classified HBF according to ISO 9772

3.3.4.2.6

HF-1 class foamed material

foamed material tested in the thinnest significant thickness used and classified HF-1 according to ISO 9772

3.3.4.2.7

HF-2 class foamed material

foamed material tested in the thinnest significant thickness used and classified HF-2 according to ISO 9772

3.3.4.2.8

V-0 class material

material tested in the thinnest significant thickness used and classified V-0 according to IEC 60695-11-10

3.3.4.2.9

V-1 class material

material tested in the thinnest significant thickness used and classified V-1 according to IEC 60695-11-10

3.3.4.2.10

V-2 class material

material tested in the thinnest significant thickness used and classified V-2 according to IEC 60695-11-10

3.3.4.2.11**VTM-0 class material**

material tested in the thinnest significant thickness used and classified VTM-0 according to ISO 9773

3.3.4.2.12**VTM-1 class material**

material tested in the thinnest significant thickness used and classified VTM-1 according to ISO 9773

3.3.4.2.13**VTM-2 class material**

material tested in the thinnest significant thickness used and classified VTM-2 according to ISO 9773

3.3.5 Insulation**3.3.5.1****basic insulation**

insulation to provide a **basic safeguard** against electric shock

Note 1 to entry: This concept does not apply to insulation used exclusively for functional purposes.

3.3.5.2**double insulation**

insulation comprising both **basic insulation** and **supplementary insulation**

[SOURCE: IEC 60050-195, Amendment 1:2001, 195-06-08]

3.3.5.3**functional insulation**

insulation between conductive parts which is necessary only for the proper functioning of the equipment

3.3.5.4**reinforced insulation**

single insulation system that provides a degree of protection against electric shock equivalent to **double insulation**

3.3.5.5**solid insulation**

solid insulating material placed between two conductive parts or between a conductive part and a body part

3.3.5.6**supplementary insulation**

independent insulation applied in addition to **basic insulation** to provide a **supplementary safeguard** for fault protection against electric shock

3.3.6 Miscellaneous**3.3.6.1****accessible**

touchable by a body part

Note 1 to entry: A body part is represented by one or more of the probes specified in Annex V, as applicable.

3.3.6.2

cheesecloth

bleached cotton cloth of approximately 40 g/m²

Note 1 to entry: **Cheesecloth** is a coarse, loosely woven cotton gauze, originally used for wrapping cheese.

3.3.6.3

disconnect device

means to electrically disconnect equipment from the **mains** that, in the open position, complies with the requirements specified for isolation

3.3.6.4

functional earth

earthing a point or points in a system or in an installation or in equipment, for purposes other than electrical safety

[SOURCE: IEC 60050-195, Amendment 1:2001, 195-01-13]

3.3.6.5

non-detachable power supply cord

flexible supply cord affixed to or assembled with the equipment and that cannot be removed without the use of **tools**

3.3.6.6

pollution degree

numeral characterising the expected pollution of the micro-environment

[SOURCE: IEC 60050-581:2008, 581-21-07]

3.3.6.7

restricted access area

area **accessible** only to **skilled persons** and **instructed persons** with the proper authorization

3.3.6.8

routine test

test to which each individual device is subjected during or after manufacture to ascertain whether it complies with certain criteria

[SOURCE: IEC 60664-1:2007, 3.19.2]

3.3.6.9

sampling test

test on a number of devices taken at random from a batch

[SOURCE: IEC 60664-1:2007, 3.19.3]

3.3.6.10

tool

object that can be used to operate a screw, latch or similar fixing means

Note 1 to entry: Examples of **tools** include coins, tableware, screwdrivers, pliers, etc.

3.3.6.11

touch current

electric current through a human body when body parts touch two or more **accessible** parts or one **accessible** part and earth

3.3.6.12

type test

test on a representative sample with the objective of determining if, as designed and manufactured, it can meet the requirements of this standard

3.3.6.13

wrapping tissue

tissue between 12 g/m² and 30 g/m²

Note 1 to entry: The **wrapping tissue** is soft, thin, usually translucent paper used for wrapping delicate articles.

3.3.7 Operating and fault conditions

3.3.7.1

abnormal operating condition

temporary operating condition that is not a **normal operating condition** and is not a **single fault condition** of the equipment itself

Note 1 to entry: **Abnormal operating conditions** are specified in Clause B.3.

Note 2 to entry: An **abnormal operating condition** may be introduced by the equipment or by a person.

Note 3 to entry: An **abnormal operating condition** may result in a failure of a component, a device or a **safeguard**.

3.3.7.2

intermittent operation

operation in a series of cycles, each composed of a period of operation followed by a period with the equipment switched off or running idle

3.3.7.3

non-clipped output power

sine wave power dissipated in the **rated load impedance**, measured at 1 000 Hz at the onset of clipping on either one or both peaks

3.3.7.4

normal operating condition

mode of operation that represents as closely as possible the range of normal use that can reasonably be expected

Note 1 to entry: Unless otherwise stated, the most severe conditions of normal use are the most unfavourable default values as specified in Clause B.2.

Note 2 to entry: Misuse is not covered by **normal operating conditions**. Instead, it is covered by **abnormal operating conditions**.

3.3.7.5

overload condition

abnormal operating condition or **single fault condition** where the load stresses the equipment or circuit beyond **normal operating conditions**, but does not, immediately, result in a non-operating state

3.3.7.6

peak response frequency

test frequency that produces the maximum output power measured at the **rated load impedance**

Note 1 to entry: The frequency applied should be within the amplifier/transducer's intended operating range.

3.3.7.7

rated load impedance

impedance or resistance as declared by the manufacturer, by which an output circuit should be terminated

3.3.7.8

reasonably foreseeable misuse

use of a product, process or service in a way not intended by the supplier, but which may result from readily predictable human behaviour

Note 1 to entry: **Reasonably foreseeable misuse** is considered to be a form of **abnormal operating conditions**.

[SOURCE: ISO/IEC Guide 51:1999, 3.14, modified – Note 1 to entry has been added.]

3.3.7.9

short-time operation

operation under **normal operating conditions** for a specified period, starting when the equipment is cold, the intervals after each period of operation being sufficient to allow the equipment to cool down to room temperature

3.3.7.10

single fault condition

condition of equipment with a fault under **normal operating condition** of a single **safeguard** (but not a **reinforced safeguard**) or of a single component or a device

Note 1 to entry: **Single fault conditions** are specified in Clause B.4.

3.3.8 Persons

3.3.8.1

instructed person

person instructed or supervised by a **skilled person** as to energy sources and who can responsibly use **equipment safeguards** and **precautionary safeguards** with respect to those energy sources

Note 1 to entry: Supervised, as used in the definition, means having the direction and oversight of the performance of others.

3.3.8.2

ordinary person

person who is neither a **skilled person** nor an **instructed person**

[SOURCE: IEC 60050-826:2004, 826-18-03]

3.3.8.3

skilled person

person with relevant education or experience to enable him or her to identify hazards and to take appropriate actions to reduce the risks of injury to themselves and others

3.3.9 Potential ignition sources

3.3.9.1

potential ignition source

PIS

location where electrical energy can cause ignition

3.3.9.2

arcing PIS

location where an arc may occur due to the opening of a conductor or a contact

Note 1 to entry: An electronic protection circuit or additional constructional measures may be used to prevent a location from becoming an **arcing PIS**.

Note 2 to entry: A faulty contact or interruption in an electric connection that may occur in conductive patterns on printed boards is considered to be within the scope of this definition.

3.3.9.3 resistive PIS

location where a component may ignite due to excessive power dissipation

3.3.10 Ratings

3.3.10.1 rated current

input current of the equipment as declared by the manufacturer at **normal operating conditions**

3.3.10.2 rated frequency

supply frequency or frequency range as declared by the manufacturer

3.3.10.3 rated power

input power of the equipment as declared by the manufacturer at **normal operating conditions**

3.3.10.4 rated voltage

value of voltage assigned by the manufacturer to a component, device or equipment and to which operation and performance characteristics are referred

Note 1 to entry: Equipment may have more than one **rated voltage** value or may have a **rated voltage range**.

[SOURCE: IEC 60664-1:2007, 3.9]

3.3.10.5 rated voltage range

supply voltage range as declared by the manufacturer expressed by its lower and upper **rated voltages**

3.3.10.6 protective current rating

current rating of an overcurrent protective device that is in the building installation or in the equipment to protect a circuit

3.3.11 Safeguards

3.3.11.1 basic safeguard

safeguard that provides protection under **normal operating conditions** and under **abnormal operating conditions** whenever an energy source capable of causing pain or injury is present in the equipment

3.3.11.2 double safeguard

safeguard comprising both a **basic safeguard** and a **supplementary safeguard**

3.3.11.3 equipment safeguard

safeguard that is a physical part of the equipment

**3.3.11.4
installation safeguard**
safeguard that is a physical part of a man-made installation

**3.3.11.5
instructional safeguard**
instruction invoking specified behaviour

**3.3.11.6
personal safeguard**
personal protective equipment that is worn on the body and that reduces exposure to an energy source

Note 1 to entry: Personal protective equipment (PPE) is a form of a **personal safeguard**. Examples are shields, goggles, gloves, aprons, face masks or breathing apparatus.

**3.3.11.7
precautionary safeguard**
instructed person behaviour to avoid contact with or exposure to a class 2 energy source based on supervision or instructions given by a **skilled person**

**3.3.11.8
protective bonding conductor**
protective conductor in the equipment, provided for protective equipotential-bonding of parts required to be earthed for safety purposes

Note 1 to entry: A **protective bonding conductor** is internal in the equipment.

**3.3.11.9
protective conductor**
conductor provided for the purposes of safety (for example, protection against electric shock)

Note 1 to entry: A **protective conductor** is either a **protective earthing conductor** or a **protective bonding conductor**.

[SOURCE: IEC 60050, Amendment 1:2001, 195-02-09]

**3.3.11.10
protective earthing conductor**
protective conductor connecting a main protective earthing terminal in the equipment to an earth point in the building installation for protective earthing

**3.3.11.11
reinforced safeguard**
single **safeguard** that is operational under:

- **normal operating conditions**;
- **abnormal operating conditions**; and
- **single fault conditions**

**3.3.11.12
safeguard**
physical part or system or instruction specifically provided to reduce the likelihood of pain or injury, or, for fire, to reduce the likelihood of ignition or spread of fire

Note 1 to entry: See 0.5 for further explanation of a **safeguard**.

3.3.11.13 safety interlock

means to automatically change an energy source to a lower class energy source prior to the potential for transfer of the higher energy to a body part

Note 1 to entry: A **safety interlock** encompasses the system of components and circuits that are directly involved in the **safeguard** function, including electro-mechanical devices, conductors on printed boards, wiring and their terminations, etc., as applicable.

3.3.11.14 skill safeguard

skilled person behaviour to avoid contact with or exposure to a class 2 or class 3 energy source based on education and experience

3.3.11.15 supplementary safeguard

safeguard applied in addition to the **basic safeguard** that is or becomes operational in the event of failure of the **basic safeguard**

3.3.12 Spacings

3.3.12.1 clearance

shortest distance in air between two conductive parts

[SOURCE: IEC 60664-1:2007, 3.2]

3.3.12.2 creepage distance

shortest distance along the surface of an insulating material between two conductive parts

[SOURCE: IEC 60664-1:2007, 3.3, modified — "solid" has been deleted.]

3.3.13 Temperature controls

3.3.13.1 temperature limiter

device for limiting the temperature of a system, either below or above a particular value, by controlling, either directly or indirectly, the flow of thermal energy into or out of the system

Note 1 to entry: A **temperature limiter** may be of the automatic reset or of the manual reset type.

3.3.13.2 thermal cut-off

device for limiting the temperature of a system, under **single fault conditions**, by controlling, either directly or indirectly, the flow of thermal energy into or out of the system

3.3.13.3 thermostat

device for maintaining the temperature of a system within a range by controlling, either directly or indirectly, the flow of thermal energy into or out of the system

3.3.14 Voltages and currents

3.3.14.1 d.c. voltage

voltage having a peak-to-peak ripple not exceeding 10 % of the average value

Note 1 to entry: Where peak-to-peak ripple exceeds 10 % of the average value, the requirements related to peak voltage are applicable.

3.3.14.2**mains transient voltage**

highest peak voltage expected at the **mains** input to the equipment arising from external transients

3.3.14.3**peak working voltage**

peak value of the **working voltage**, including any d.c. component and any repetitive peak impulses generated in the equipment

3.3.14.4**prospective touch voltage**

voltage between simultaneously **accessible** conductive parts when those conductive parts are not being touched

3.3.14.5**protective conductor current**

current flowing through the **protective earthing conductor** under **normal operating conditions**

Note 1 to entry: **Protective conductor current** was previously included in the term "leakage current".

3.3.14.6**required withstand voltage**

peak voltage that the insulation under consideration is required to withstand

3.3.14.7**r.m.s. working voltage**

true r.m.s. value of the **working voltage**

Note 1 to entry: True r.m.s. measurement includes any d.c. component of the waveform.

Note 2 to entry: The resultant r.m.s. value of a waveform having an a.c. r.m.s. voltage A and a d.c. offset voltage B is given by the following formula:

$$\text{r.m.s. value} = (A^2 + B^2)^{1/2}$$

3.3.14.8**temporary overvoltage**

overvoltage at **mains** power frequency of relatively long duration

3.3.14.9**working voltage**

highest voltage across any particular insulation that can occur when the equipment is supplied at **rated voltage** or any voltage in the **rated voltage range** under **normal operating conditions**

Note 1 to entry: External transients are disregarded.

3.3.15 Classes of equipment with respect to protection from electric shock**3.3.15.1****class I equipment**

equipment in which protection against electric shock does not rely on **basic insulation** only, but that includes a **supplementary safeguard** in such a way that means are provided for the connection of **accessible** conductive parts to the **protective earthing conductor** in the fixed wiring of the installation

Note 1 to entry: For equipment intended for use with a flexible cord or cable, this provision includes a **protective conductor** as part of the flexible cord or cable.

Note 2 to entry: **Class I equipment** may be provided with **class II construction**.

3.3.15.2**class II construction**

part of an equipment for which protection against electric shock relies upon **double insulation** or **reinforced insulation**

3.3.15.3**class II equipment**

equipment in which protection against electric shock does not rely on **basic insulation** only, but in which a **supplementary safeguard** is provided, there being no provision for protective earthing or reliance upon installation conditions

3.3.15.4**class III equipment**

equipment in which protection against electric shock relies upon supply from ES1 and in which ES3 is not generated

3.3.16 Chemical terms**3.3.16.1****consumable material**

material that is used by the equipment in performing its intended function, and intended to be periodically or occasionally replaced or replenished, including any material that has a life expectancy less than that of the equipment

3.3.16.2**explosion**

chemical reaction of any chemical compound or mechanical mixture that, when initiated, undergoes a very rapid combustion or decomposition, releasing large volumes of highly heated gases that exert pressure on the surrounding medium

Note 1 to entry: **Explosion** can also be a mechanical reaction in which failure of the container causes sudden release of pressure, and the contents, from within a pressure vessel. Depending on the rate of energy release, an **explosion** can be categorized as a deflagration, a detonation or pressure rupture.

3.3.16.3**explosive**

substance or mixture of substances that can undergo a rapid chemical change with or without an outside source of oxygen, generating large quantities of energy generally accompanied by hot gases

3.3.16.4**hazardous substance**

substance that has the potential for adversely impacting human health

Note 1 to entry: The criteria for determining whether a substance is classified as hazardous are usually defined by law or regulation.

3.3.17 Batteries**3.3.17.1****battery**

assembly of **cell(s)** ready for use as a source of electrical energy characterized by its voltage, size, terminal arrangement, capacity and rate capability

Note 1 to entry: The term **battery** pack is considered to be a **battery**.

3.3.17.2**cell**

basic manufactured unit providing a source of electrical energy by direct conversion of chemical energy, that consists of electrodes, separators, electrolyte, container and terminals

3.3.17.3

coin / button cell battery

small, single **cell battery** having a diameter greater than its height

3.3.17.4

highest specified charging temperature

highest temperature specified by the manufacturer at a site on each individual **cell** comprising the **battery** during charging of a secondary **battery**

Note 1 to entry: It is usually assumed that the end-product manufacturer is responsible to specify the safety-sensitive temperature, voltage or current of the **battery**, based on the specifications provided by **battery** supplier.

3.3.17.5

lowest specified charging temperature

lowest temperature as declared by the manufacturer at a site on each individual **cell** comprising the **battery** during charging of a secondary **battery**

3.3.17.6

maximum specified charging current

highest charging current as declared by the manufacturer during charging of a secondary **battery**

3.3.17.7

maximum specified charging voltage

highest charging voltage as declared by the manufacturer during charging of a secondary **battery**

3.3.17.8

secondary lithium battery

battery that incorporates:

- one or more secondary lithium **cells**; and
- a housing and a terminal arrangement; and
- may have electronic control devices; and
- that is ready for use.

Note 1 to entry: Examples of a **secondary lithium battery** include a rechargeable lithium-ion **battery**, a rechargeable lithium-polymer **battery** and a rechargeable lithium manganese **battery**.

4 General requirements

4.1 General

4.1.1 Application of requirements and acceptance of materials, components and subassemblies

Requirements are specified in the relevant clauses and, where referenced in those clauses, in the relevant annexes.

Where compliance of materials, components or subassemblies is demonstrated by inspection, such compliance may be by review of published data or previous test results.

Components and subassemblies that comply with IEC 60950-1 or IEC 60065 are acceptable as part of equipment covered by this standard without further evaluation other than to give consideration to the appropriate use of the component or subassembly in the end-product.

NOTE This paragraph will be deleted in edition 3 of this standard. It is added here to provide a smooth transition from the latest editions of IEC 60950-1 and IEC 60065 to this standard.

4.1.2 Use of components

Where the component, or a characteristic of a component, is a **safeguard** or a part of a **safeguard**, components shall comply with the requirements of this standard or, where specified in a requirements clause, with the safety aspects of the relevant IEC component standards.

NOTE 1 An IEC component standard is considered relevant only if the component in question clearly falls within its scope.

NOTE 2 The applicable test for compliance with a component standard is, in general, conducted separately

Where use of an IEC component standard is permitted above, evaluation and testing of components shall be conducted as follows:

- a component shall be checked for correct application and use in accordance with its rating;
- a component that has been demonstrated to comply with a standard harmonized with the relevant IEC component standard shall be subjected to the applicable tests of this standard, as part of the equipment, with the exception of those tests that are part of the relevant IEC component standard;
- a component that has not been demonstrated to comply with a relevant standard as above shall be subjected to the applicable tests of this standard, as part of the equipment, and to the applicable tests of the component standard, under the conditions occurring in the equipment; and
- where components are used in circuits not in accordance with their specified ratings, the components shall be tested under the conditions occurring in the equipment. The number of samples required for test is, in general, the same as required by an equivalent standard.

Compliance is checked by inspection and by the relevant data or tests.

4.1.3 Equipment design and construction

Equipment shall be so designed and constructed that, under **normal operating conditions** (see Clause B.2), **abnormal operating conditions** (see Clause B.3), and **single fault conditions** (see Clause B.4), **safeguards** are provided to reduce the likelihood of injury or, in the case of fire, property damage.

Parts of equipment that could cause injury shall not be **accessible**, and **accessible** parts shall not cause an injury.

For an **ordinary person** or an **instructed person**, the adjustment of a control shall not defeat an **equipment safeguard**.

Compliance is checked by inspection and by the relevant tests.

4.1.4 Equipment installation

The equipment evaluation according to this standard shall take into account manufacturer's instructions with regard to installation, relocation, servicing and operation, as applicable.

4.1.5 Constructions and components not specifically covered

Where the equipment involves technologies, components and materials or methods of construction not specifically covered in this standard, the equipment shall provide **safeguards** not less than that generally afforded by this standard and the principles of safety contained herein.

The need for additional detailed requirements to cope with a new situation should be brought promptly to the attention of the appropriate committee.

4.1.6 Orientation during transport and use

Where it is clear that the orientation of use of equipment is likely to have a significant effect on the application of the requirements or the results of tests, all orientations of use specified in the installation or user instructions shall be taken into account. In addition, for **transportable equipment**, all orientations of transport shall be taken into account.

4.1.7 Choice of criteria

Where the standard indicates a choice between different criteria for compliance, or between different methods or conditions of test, the choice is specified by the manufacturer.

4.1.8 Conductive liquids

For the electrical requirements of this standard, conductive liquids shall be treated as conductive parts.

4.1.9 Electrical measuring instruments

Electrical measuring instruments shall have adequate bandwidth to provide accurate readings, taking into account all components (d.c., **mains** frequency, high frequency and harmonic content) of the parameter being measured.

If an r.m.s. value is measured, care shall be taken that the measuring instrument gives a true r.m.s. reading of non-sinusoidal waveforms as well as sinusoidal waveforms.

Measurements are made with a meter whose input impedance has a negligible influence on the measurement.

4.1.10 Temperature measurements

Unless stated otherwise, where the result of a test is likely to depend upon the ambient temperature, the manufacturer's specified ambient temperature range of the equipment (T_{ma}) shall be taken into account. When performing the test at a specific ambient (T_{amb}), extrapolation (above and below) the results of the test may be used to consider the impact of

T_{ma} on the result. Components and subassemblies may be considered separately from the equipment if the test results and extrapolation is representative of the whole equipment being so tested. Relevant test data and manufacturer's specifications may be examined in order to determine the effect of temperature variability on a component or subassembly (see B.1.6).

4.1.11 Steady state conditions

Steady state conditions are conditions when temperature stability is considered to exist (see B.1.6).

4.1.12 Hierarchy of safeguards

Safeguards that are required for **ordinary persons** are acceptable, but may not be required, for **instructed persons** and **skilled persons**. Likewise, **safeguards** that are required for **instructed persons** are acceptable, but may not be required, for **skilled persons**.

A **reinforced safeguard** may be used in place of a **basic safeguard** or a **supplementary safeguard** or a **double safeguard**. A **double safeguard** may be used in place of a **reinforced safeguard**.

Safeguards, other than **equipment safeguards**, may be specified in specific clauses (for example, see 8.4.1, 8.5.1 and Table 38).

4.1.13 Examples mentioned in the standard

Where examples are given in this standard, other examples, situations, and solutions are not excluded.

4.1.14 Tests on parts or samples separate from the end-product

If a test is conducted on a part or sample separate from the end-product, the test shall be conducted as if the part or sample was in the end-product.

4.1.15 Markings and instructions

Equipment that is required by this standard to:

- bear markings; or
- be provided with instructions; or
- be provided with **instructional safeguards**

shall meet the relevant requirements of Annex F.

Compliance is checked by inspection.

NOTE In Finland, Norway and Sweden, **class I pluggable equipment type A** intended for connection to other equipment or a network shall, if safety relies on connection to reliable earthing or if surge suppressors are connected between the network terminals and **accessible** parts, have a marking stating that the equipment must be connected to an earthed **mains** socket-outlet.

4.2 Energy source classifications

4.2.1 Class 1 energy source

Unless otherwise specified, a class 1 source is an energy source with levels not exceeding class 1 limits under:

- **normal operating conditions**; and

- **abnormal operating conditions** that do not lead to a **single fault condition**; and
- **single fault conditions** that do not result in class 2 limits being exceeded.

Under **normal operating conditions** and **abnormal operating conditions**, the energy in a class 1 source, in contact with a body part, may be detectable, but is not painful nor is it likely to cause an injury. For fire, the energy in a class 1 source is not likely to cause ignition.

Under **single fault conditions**, a class 1 energy source, under contact with a body part, may be painful, but is not likely to cause injury.

4.2.2 Class 2 energy source

Unless otherwise specified, a class 2 source is an energy source with levels exceeding class 1 limits and not exceeding class 2 limits under **normal operating conditions**, **abnormal operating conditions**, or **single fault conditions**. The energy in a class 2 source, under contact with a body part, may be painful, but is not likely to cause an injury. For fire, the energy in a class 2 source can cause ignition under some conditions.

4.2.3 Class 3 energy source

A class 3 source is an energy source with levels exceeding class 2 limits under **normal operating conditions**, **abnormal operating conditions**, or **single fault conditions**, or any energy source declared to be a class 3 source. The energy in a class 3 source, under contact with a body part, is capable of causing injury. For fire, the energy in a class 3 source may cause ignition and the spread of flame where fuel is available.

4.2.4 Energy source classification by declaration

The manufacturer may declare:

- a class 1 energy source to be either a class 2 energy source or a class 3 energy source;
- a class 2 energy source to be a class 3 energy source.

A neutral conductor is considered to be a class 3 electrical energy source.

A **protective conductor** is considered to be a class 1 electrical energy source.

4.3 Protection against energy sources

4.3.1 General

The terms "persons", "body", and "body parts" are represented by the probes of Annex V.

4.3.2 Safeguards for protection of an ordinary person

4.3.2.1 Safeguards between a class 1 energy source and an ordinary person

No **safeguards** are required between a class 1 energy source and an **ordinary person** (see Figure 9). Consequently, a class 1 energy source may be **accessible** to an **ordinary person**.

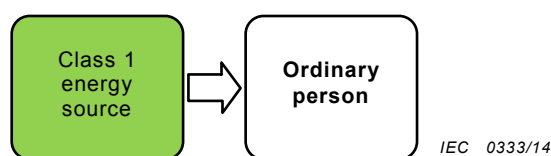

Figure 9 – Model for protection of an ordinary person against a class 1 energy source

4.3.2.2 Safeguards between a class 2 energy source and an ordinary person

At least one **basic safeguard** is required between a class 2 energy source and an **ordinary person** (see Figure 10).

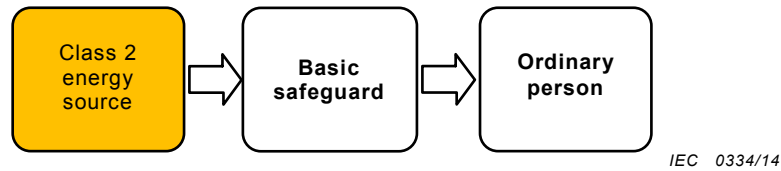

Figure 10 – Model for protection of an ordinary person against a class 2 energy source

4.3.2.3 Safeguards between a class 2 energy source and an ordinary person during ordinary person servicing conditions

If **ordinary person** servicing conditions require a **basic safeguard** to be removed or defeated, an **instructional safeguard** as described in Clause F.5 shall be provided and located in such a way that an **ordinary person** will see the instruction prior to removing or defeating the **basic safeguard** (see Figure 11).

The **instructional safeguard** (see Clause F.5) shall include all of the following:

- identify parts and locations of the class 2 energy source;
- specify actions that will protect persons from that energy source; and
- specify actions to reinstate or restore the **basic safeguard**.

If **ordinary person** servicing conditions require a **basic safeguard** to be removed or defeated, and where the equipment is intended for use in the home, an **instructional safeguard** (see Clause F.5), directed towards adults, shall warn against removing or defeating the **basic safeguard** by children.

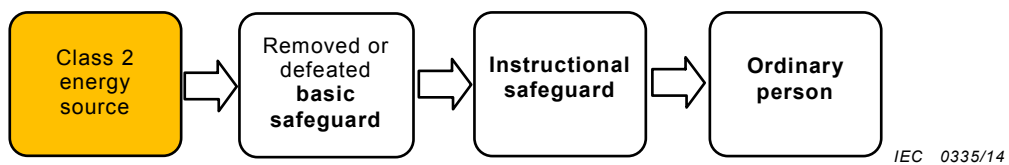

Figure 11 – Model for protection of an ordinary person against a class 2 energy source during ordinary person servicing conditions

4.3.2.4 Safeguards between a class 3 energy source and an ordinary person

Unless otherwise specified,

- an **equipment basic safeguard** and an **equipment supplementary safeguard** (together forming a **double safeguard**); or
- a **reinforced safeguard**

is required between a class 3 energy source and an **ordinary person** (see Figure 12).

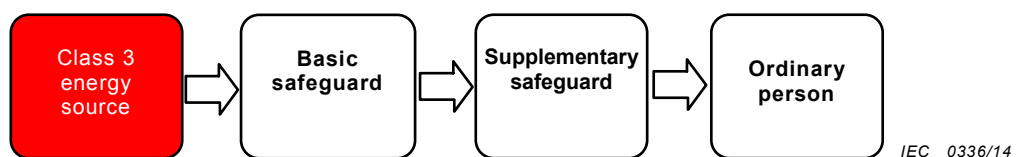

Figure 12 – Model for protection of an ordinary person against a class 3 energy source

4.3.3 Safeguards for protection of an instructed person

4.3.3.1 Safeguards between a class 1 energy source and an instructed person

No **safeguards** are required between a class 1 energy source and an **instructed person** (see Figure 13).

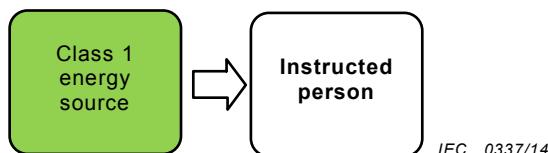

Figure 13 – Model for protection of an instructed person against a class 1 energy source

4.3.3.2 Safeguards between a class 2 energy source and an instructed person

An **instructed person** uses a **precautionary safeguard** (see Figure 14). No additional **safeguards** are required between a class 2 energy source and an **instructed person**. Consequently, a class 2 energy source may be **accessible** to an **instructed person**.

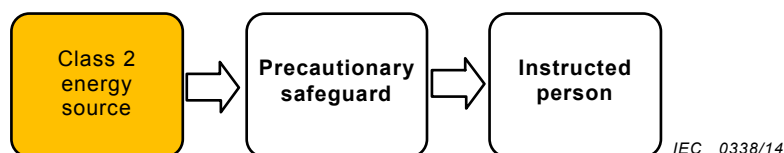

Figure 14 – Model for protection of an instructed person against a class 2 energy source

4.3.3.3 Safeguards between a class 3 energy source and an instructed person

Unless otherwise specified,

- an **equipment basic safeguard** and an **equipment supplementary safeguard** (together forming a **double safeguard**); or
- a **reinforced safeguard**

is required between a class 3 energy source and an **instructed person** (see Figure 15).

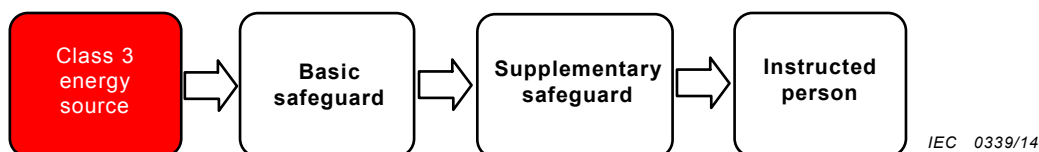

Figure 15 – Model for protection of an instructed person against a class 3 energy source

4.3.4 Safeguards for protection of a skilled person

4.3.4.1 Safeguards between a class 1 energy source and a skilled person

No **safeguard** is required between a class 1 energy source and a **skilled person**. Consequently, a class 1 energy source may be **accessible** to a **skilled person** (see Figure 16).

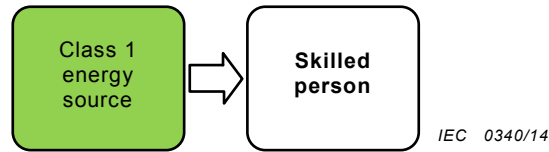

Figure 16 – Model for protection of a skilled person against a class 1 energy source

4.3.4.2 Safeguards between a class 2 energy source and a skilled person

A **skilled person** uses a **skill safeguard** (see Figure 17). No additional **safeguards** are required between a class 2 energy source and a **skilled person**. Consequently, a class 2 energy source may be **accessible** to a **skilled person**.

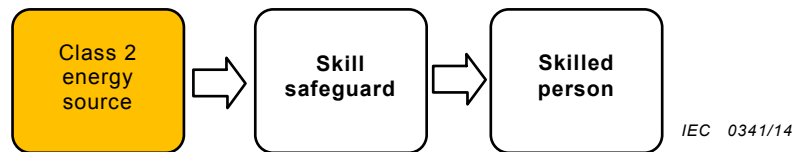

Figure 17 – Model for protection of a skilled person against a class 2 energy source

4.3.4.3 Safeguards between a class 3 energy source and a skilled person

A **skilled person** uses a **skill safeguard** (see Figure 18). Unless otherwise specified, no additional **safeguards** are required between a class 3 energy source and a **skilled person**. Consequently, a class 3 energy source may be **accessible** to a **skilled person**.

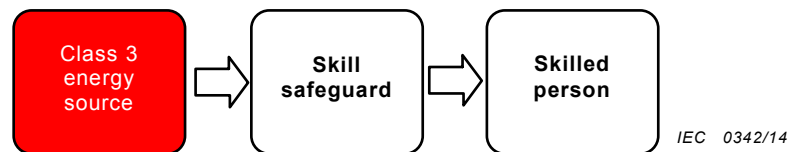

Figure 18 – Model for protection of a skilled person against a class 3 energy source

During equipment servicing conditions on a class 3 energy source, a **safeguard** intended to reduce the likelihood of injury due to an involuntary reaction is required between:

- another class 3 energy source, not undergoing service and in the same vicinity as the class 3 energy source being serviced; and
- a **skilled person** (see 0.5.7 and Figure 19).

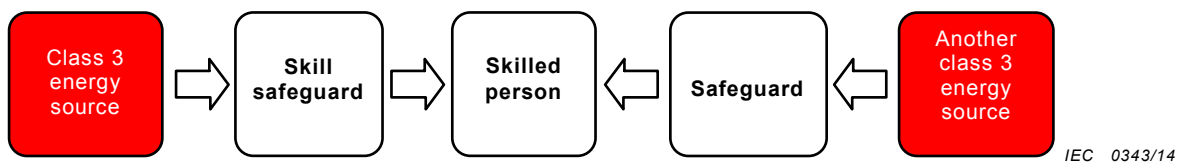

Figure 19 – Model for protection of a skilled person against class 3 energy sources during equipment servicing conditions

4.3.5 Safeguards in a restricted access area

Certain equipment is intended for installation exclusively in **restricted access areas**. Such equipment shall have **safeguards** as required in 4.3.3 for **instructed persons** and 4.3.4 for **skilled persons**.

4.4 Safeguards

4.4.1 Equivalent materials or components

Where this standard specifies a particular **safeguard** parameter, such as thermal class of insulation or **material flammability class**, a **safeguard** with a better parameter may be used.

NOTE For a hierarchy of the **material flammability classes** see Table S.1, Table S.2 and Table S.3.

4.4.2 Composition of a safeguard

A **safeguard** may be comprised of one or more elements.

4.4.3 Accessible parts of a safeguard

Where a solid **safeguard** is **accessible** to an **ordinary person** or to an **instructed person**, only the side of the **safeguard** opposite to the energy source may be **accessible**.

4.4.4 Safeguard robustness

4.4.4.1 General

Where a solid **safeguard** (for example, an **enclosure**, barrier, **solid insulation**, earthed metal, glass, etc.) is **accessible** to an **ordinary person** or to an **instructed person**, the **safeguard** shall comply with the relevant robustness tests as specified in 4.4.4.2 to 4.4.4.9.

A solid **safeguard** that is not **accessible** shall comply with the stress relief test of Clause T.8.

For a **safeguard** that is **accessible** after opening an external **enclosure**, see 4.4.4.5.

Requirements for:

- adhesion of metalized coatings; and
- adhesives securing parts serving as **safeguards**; and
- parts that may defeat a **safeguard** if an adhesive fails

are specified in Clause P.4.

4.4.4.2 Steady force tests

An **enclosure** or barrier that is **accessible** and that is used as a **safeguard** of:

- **transportable equipment**; and
- **hand-held equipment**; and
- **direct plug-in equipment**;

shall be subjected to the steady force test of Clause T.4.

For all other equipment, an **enclosure** or barrier that is **accessible** and that is used as a **safeguard** shall be subjected to the steady force test of Clause T.5. There are no requirements for the bottom of equipment having a mass of more than 18 kg unless the user instructions permit an orientation in which the bottom of the **enclosure** becomes the top or a side of the equipment.

A **safeguard** that is **accessible** and that only acts as a **fire enclosure** or barrier shall be subjected to the steady force test of Clause T.3.

This subclause does not apply to glass. Requirements for glass are given in 4.4.4.6.

4.4.4.3 Drop tests

The following equipment shall be subjected to the drop test of Clause T.7:

- **hand-held equipment;**
- **direct plug-in equipment;**
- **transportable equipment;**
- **movable equipment** requiring lifting or handling by an **ordinary person** as part of its intended use, including routine relocation;

NOTE An example of such equipment is a paper shredder that rests on a waste container, requiring its removal to empty the container.

- desk-top or table-top equipment having a mass of 7 kg or less that is intended for use with any one of the following:
 - a cord-connected telephone handset, or
 - another cord-connected hand-held accessory with an acoustic function, or
 - a headset.

4.4.4.4 Impact tests

All equipment, other than that specified in 4.4.4.3, shall be subjected to the impact test of Clause T.6.

The impact test of Clause T.6 is not applied to the following:

- the bottom of an **enclosure**, except if the user instructions permit an orientation in which the bottom of the **enclosure** becomes the top or a side of the equipment;
- glass;

NOTE Impact tests for glass are in 4.4.4.6.

- the surface of the **enclosure** of **stationary equipment**, including equipment for building-in, that is not **accessible** and is protected after installation.

4.4.4.5 Internal accessible safeguard tests

An internal solid **safeguard** that is **accessible** to an **ordinary person** after opening an external **enclosure** and whose failure would allow class 2 or class 3 energy sources to be **accessible** shall be subjected to the steady force test of Clause T.3.

4.4.4.6 Glass impact tests

The requirements below are applicable to all parts made of glass, with the exception of:

- platen glass used on copiers, scanners and the like, provided that the glass complies with 4.4.4.5 and is covered during normal use; and
- CRTs: Requirements for CRTs are given in Annex U; and
- glass that is laminated or has a construction such that glass particles do not separate from each other if the glass is broken; and

NOTE Laminated glass includes constructions such as plastic film affixed to single side of a glass.

- a **safeguard** that is **accessible** and that acts as a **fire enclosure** only.

Glass that is **accessible** to an **ordinary person** or to an **instructed person**:

- having a surface area exceeding 0,1 m²; or
- having a major dimension exceeding 450 mm; or

- that prevents access to class 3 energy sources other than PS3,
shall be subjected to the glass impact test of Clause T.9.

4.4.4.7 Thermoplastic material tests

If a **safeguard** is of thermoplastic material, the **safeguard** shall be so constructed that any shrinkage or distortion of the material due to release of internal stresses shall not defeat its **safeguard** function. The thermoplastic material shall be subjected to the stress relief test of Clause T.8.

4.4.4.8 Air comprising a safeguard

Where a **safeguard** is comprised of air (for example, a **clearance**), a barrier or **enclosure** shall prevent displacement of the air by a body part or a conductive part. The barrier shall comply with the mechanical strength test specified in Annex T, as applicable.

4.4.4.9 Compliance criteria

During and after the tests:

- *except for PS3, class 3 energy sources shall not become **accessible** to an **ordinary person** or to an **instructed person**; and*
- *glass shall:*
 - *not break or crack; or*
 - *not expel pieces of glass greater than 30 g in mass or greater than 50 mm in any dimension; or*
 - *pass the fragmentation test of Clause T.10 on a separate test sample; and*
- *all other **safeguards** shall remain effective.*

4.5 Explosion

4.5.1 General

Explosion can be caused by

- chemical reaction,
- mechanical deformation of a sealed container,
- rapid combustion or decomposition, producing a large volume of hot gas,
- high pressure, or
- high temperature.

NOTE 1 Depending on the energy rate, **explosion** can be categorized as a deflagration, a detonation, or pressure rupture.

NOTE 2 An ultracapacitor (for example, a double layer capacitor) is a high energy source and can explode following overcharging and high temperature.

For requirements regarding **explosion** of **batteries**, see Annex M.

4.5.2 Requirements

During **normal operating conditions** and **abnormal operating conditions**, an **explosion** shall not occur.

If an **explosion** occurs during **single fault conditions**, it shall not cause harm and the equipment shall comply with the relevant parts of this standard.

Compliance is checked by inspection and tests as specified in Clause B.2, Clause B.3 and Clause B.4.

4.6 Fixing of conductors

4.6.1 Requirements

Conductors shall be such that displacement cannot defeat a **safeguard**, such as reducing **clearances** or **creepage distances** below the values specified in 5.4.2 and 5.4.3.

The fixing of the conductors shall be such that, if a conductor becomes loose or detached, the conductor cannot defeat a **safeguard**, such as reducing **clearances** or **creepage distances** below the values specified in 5.4.2 and 5.4.3.

For the purpose of these requirements, it is assumed that:

- two independent fixings will not become loose or detached at the same time; and
- parts fixed by means of screws or nuts provided with self-locking washers or other means of locking are not liable to become loose or detached.

NOTE Spring washers and the like can provide satisfactory locking.

4.6.2 Compliance criteria

Compliance is checked by inspection, by measurement or in case of doubt by applying a force of 10 N in the most unfavourable direction.

EXAMPLE Constructions regarded as meeting the requirements include:

- close-fitting tubing (for example, a heat shrink or rubber sleeve), applied over the wire and its termination;
- conductors connected by soldering and held in place near to the termination, independently of the soldered connection;
- conductors connected by soldering and securely hooked in before soldering, provided that the hole through which the conductor is passed is not unduly large;
- conductors connected to screw terminals, with an additional fixing near to the terminal that clamps, in the case of stranded conductors, the insulation and not only the conductors;
- conductors connected to screw terminals and provided with terminators that are unlikely to become free (for example, ring lugs crimped onto the conductors), however, the pivoting of such terminators is considered; or
- short rigid conductors that remain in position when the terminal screw is loosened.

4.7 Equipment for direct insertion into mains socket-outlets

4.7.1 General

Equipment incorporating integral pins for insertion into **mains** socket-outlets shall not impose undue torque on the socket-outlet. The means for retaining the pins shall withstand the forces to which the pins are likely to be subjected in normal use.

4.7.2 Requirements

The **mains** plug part shall comply with the relevant standard for the **mains** plug.

The equipment is inserted, as in normal use, into a fixed socket-outlet of a configuration as intended by the manufacturer, which is pivoted about a horizontal axis intersecting the centre lines of the contacts at a distance of 8 mm behind the engagement face of the socket outlet parallel to the engagement face.

4.7.3 Compliance criteria

Compliance is checked by inspection and, the additional torque that has to be applied to the socket-outlet to maintain the engagement face in the vertical plane shall not exceed 0,25 Nm. The torque to keep the socket-outlet itself in the vertical plane is not included in this value.

NOTE 1 In Australia and New Zealand, compliance is checked in accordance with AS/NZS 3112.

NOTE 2 In the United Kingdom, the torque test is performed using a socket-outlet complying with BS 1363, and the plug part shall be assessed to the relevant clauses of BS 1363.

4.8 Products containing lithium coin / button cell batteries

4.8.1 General

These requirements apply to equipment, including remote controls, that:

- are likely to be **accessible** to children, taking into account information given by the manufacturer; and
- include lithium **coin / button cell batteries** with a diameter of 32 mm or less.

These requirements do not apply to:

- professional equipment;

NOTE Professional equipment is equipment sold through special sales channels. All equipment sold through normal electronics stores are considered not to be professional equipment.

- equipment for locations where it is unlikely that children will be present; or
- equipment containing lithium **coin / button cell batteries** that are soldered in place.

4.8.2 Instructional safeguard

Equipment containing one or more lithium **coin / button cell batteries** shall have an **instructional safeguard** in accordance with Clause F.5.

The **instructional safeguard** is not required where these **batteries** are not intended to be replaced or are only **accessible** after damaging the equipment.

The elements of the **instructional safeguard** shall be as follows:

- element 1a: not available
- element 2: “Do not ingest battery, Chemical Burn Hazard” or equivalent wording
- element 3: the following or equivalent text

[The remote control supplied with] This product contains a coin / button cell battery. If the coin / button cell battery is swallowed, it can cause severe internal burns in just 2 hours and can lead to death.
- element 4: the following or equivalent text

Keep new and used batteries away from children.

If the battery compartment does not close securely, stop using the product and keep it away from children.

If you think batteries might have been swallowed or placed inside any part of the body, seek immediate medical attention.

4.8.3 Construction

Equipment having a **battery** compartment door / cover shall be designed to reduce the possibility of children removing the **battery** by one of the following methods:

- a **tool**, such as a screwdriver or coin, is required to open the **battery** compartment; or

- the **battery** compartment door / cover requires the application of a minimum of two independent and simultaneous movements to open by hand.

4.8.4 Tests

4.8.4.1 Test sequence

One sample shall be subjected to the applicable tests of 4.8.4.2 to 4.8.4.6. If applicable, the test in 4.8.4.2 shall be conducted first.

4.8.4.2 Stress relief test

*If the **battery** compartment utilizes moulded or formed thermoplastic materials, the sample consisting of the complete equipment, or of the complete **enclosure** together with any supporting framework, is tested according to the stress relief test of Clause T.8.*

*During the test, the **battery** may be removed.*

4.8.4.3 Battery replacement test

*For equipment with a **battery** compartment door / cover, the **battery** compartment shall be opened and closed and the **battery** removed and replaced ten times to simulate normal replacement according to the manufacturer's instructions.*

*If the **battery** compartment door / cover is secured by one or more screws, the screws are loosened and then tightened applying a continuous linear torque according to Table 37, using a suitable screwdriver, spanner or key. The screws are to be completely removed and reinserted each time*

4.8.4.4 Drop test

*Portable equipment having a mass of 7 kg or less are subjected to three drops from a height of 1 m onto a horizontal surface in positions likely to produce the maximum force on the **battery** compartment in accordance with Clause T.7.*

If the equipment is a remote control, it shall be subjected to ten drops.

4.8.4.5 Impact test

*The **battery** compartment door / cover shall be subjected to three impacts in a direction perpendicular to the **battery** compartment door / cover according to the test method of Clause T.6 with a force of:*

- 0,5 J (102 mm \pm 10 mm height) for glasses for watching, for example, 3 dimensional television; or
- 2 J (408 mm \pm 10 mm height) for all other doors / covers.

4.8.4.6 Crush test

Hand held remote control devices are to be supported by a fixed rigid supporting surface in a position likely to produce the most adverse results as long as the position can be self-supported. A crushing force of 330 N \pm 5 N is applied to the exposed top and back surfaces of remote control devices placed in a stable condition by a flat surface measuring approximately 100 mm by 250 mm for a period of 10 s.

4.8.5 Compliance criteria

*Compliance is checked by applying a force of 30 N \pm 1 N for 10 s to the **battery** compartment door / cover by a rigid test finger according to the test probe of Figure V.2 at the most*

unfavourable place and in the most unfavourable direction. The force shall be applied in one direction at a time.

The **battery** compartment door / cover shall remain functional, and:

- the **battery** shall not become **accessible**; or
- it shall not be possible remove the **battery** from the product with the test hook of Figure 20 using a force of approximately 20 N.

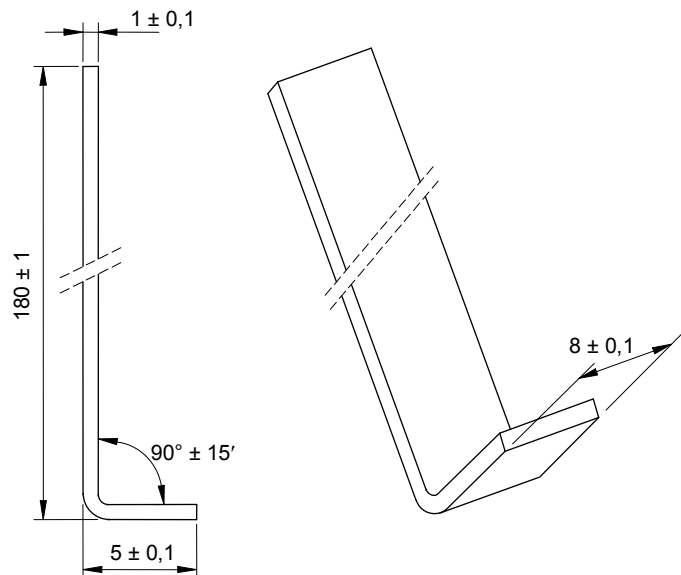

IEC 1403/12

Material: steel

Dimensions in millimetres

Figure 20 – Test hook

4.9 Likelihood of fire or shock due to entry of conductive objects

Where the entry of a conductive object from outside the equipment or from another part of the equipment can result in:

- bridging within PS2, PS3 and ES3 circuits; or
- bridging an ES3 circuit to **accessible**, unearthed conductive parts,

top and side openings above PS2, PS3 and ES3 circuits shall:

- be located more than 1,8 m above the floor; or
- comply with Annex P.

Compliance is checked by inspection or according to Annex P.

5 Electrically-caused injury

5.1 General

To reduce the likelihood of painful effects and injury due to electric current passing through the human body, equipment shall be provided with the **safeguards** specified in Clause 5.

5.2 Classification and limits of electrical energy sources

5.2.1 Electrical energy source classifications

5.2.1.1 ES1

ES1 is a class 1 electrical energy source with current or voltage levels

- not exceeding ES1 limits under
 - **normal operating conditions**, and
 - **abnormal operating conditions**, and
 - **single fault conditions** of a component, device or insulation not serving as a **safeguard**; and
- not exceeding ES2 limits under **single fault conditions** of a **basic safeguard**.

5.2.1.2 ES2

ES2 is a class 2 electrical energy source where

- both the **prospective touch voltage** and the **touch current** exceed the limits for ES1; and
- under
 - **normal operating conditions**, and
 - **abnormal operating conditions**, and
 - **single fault conditions**,

either the **prospective touch voltage** or the **touch current** does not exceed the limit for ES2.

5.2.1.3 ES3

ES3 is a class 3 electrical energy source where both the **prospective touch voltage** and **touch current** exceed the limit for ES2.

5.2.2 Electrical energy source ES1 and ES2 limits

5.2.2.1 General

The limits specified in 5.2.2 are with respect to earth or with respect to an **accessible** part.

NOTE Throughout 5.2.2, the term “voltage” is taken to mean “**prospective touch voltage**.” Likewise, the term “current” is taken to mean “**touch current**.”

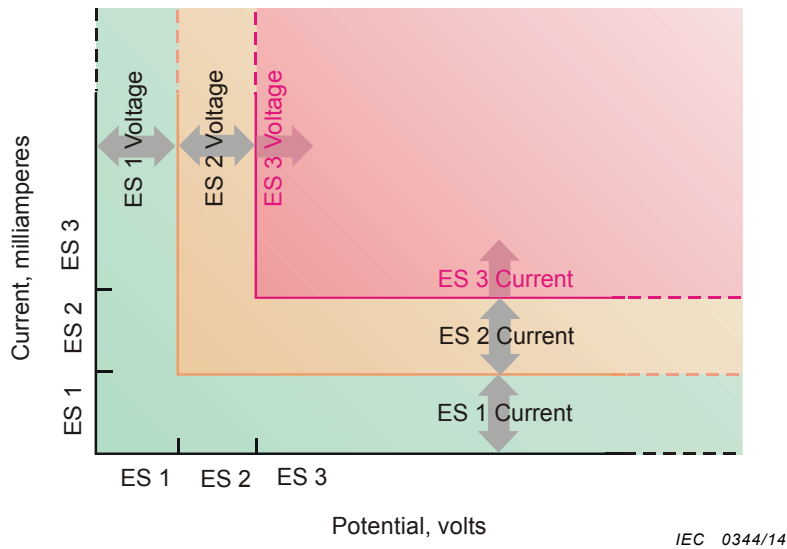

Figure 21 – Illustration showing ES limits for voltage and current

For any voltage up to the voltage limit, there is no limit for the current. Likewise for any current up to the current limit, there is no limit for the voltage, see Figure 21.

5.2.2.2 Steady-state voltage and current limits

An electrical energy source class is determined from both the voltage and the current under **normal operating conditions**, **abnormal operating conditions**, and **single fault conditions** (see Table 4).

The values are the maximum that can be delivered by the source. Steady state is considered established when the voltage or current values persist for 2 s or longer, otherwise the limits of 5.2.2.3, 5.2.2.4 or 5.2.2.5 apply, as appropriate.

NOTE In Denmark a warning (marking **safeguard**) for high **touch current** is required if the **touch current** exceeds the limits of 3,5 mA a.c. or 10 mA d.c.

Table 4 – Electrical energy source limits for steady-state ES1 and ES2

Energy source	ES1 limits		ES2 limits		ES3
	Voltage	Current ^{a, c}	Voltage	Current ^{b, c}	
d.c.	60 V	2 mA	120 V	25 mA	> ES2
a.c. up to 1 kHz	30 V r.m.s. 42,4 V peak	0,5 mA r.m.s. 0,707 mA peak	50 V r.m.s. 70,7 V peak	5 mA r.m.s. 7,07 mA peak	
a.c. > 1 kHz up to 100 kHz	30 V r.m.s. + 0,4 <i>f</i>		50 V r.m.s. + 0,9 <i>f</i>		
a.c. above 100 kHz	70 V r.m.s.		140 V r.m.s.		
Combined a.c. and d.c.	$\frac{U_{dc} \text{ V}}{60} + \frac{U_{ac} \text{ V r.m.s.}}{30} \leq 1$ $\frac{U_{dc} \text{ V}}{60} + \frac{U_{ac} \text{ V peak}}{42,4} \leq 1$	$\frac{I_{dc} \text{ mA}}{2} + \frac{I_{ac} \text{ mA r.m.s.}}{0,5} \leq 1$ $\frac{I_{dc} \text{ mA}}{2} + \frac{I_{ac} \text{ mA peak}}{0,707} \leq 1$	See Figure 23	See Figure 22	
The formulation below as a function of frequency may be of interest to designers for sinusoidal waveforms					
Energy source	ES1 limits		ES2 limits		ES3
	Current ^c r.m.s.		Current ^c r.m.s.		
a.c. up to 1 kHz	0,5 mA		5 mA		> ES2
a.c. > 1 kHz up to 100 kHz	0,5 mA × <i>f</i> ^d		5 mA + 0,95 <i>f</i> ^e		
a.c. above 100 kHz	50 mA ^d		100 mA ^e		
<p><i>f</i> is in kHz.</p> <p>Peak values shall be used for non-sinusoidal voltage and current. RMS values may be used only for sinusoidal voltage and current.</p> <p>See 5.7 for measurement of prospective touch voltage and touch current.</p> <p>^a Current is measured using the measuring network specified in Figure 4, IEC 60990:1999.</p> <p>^b Current is measured using the measuring network specified in Figure 5, IEC 60990:1999.</p> <p>^c For sinusoidal waveforms and d.c., the current may be measured using a 2 000 Ω resistor.</p> <p>^d Above 22 kHz the accessible area is limited to 1 cm².</p> <p>^e Above 36 kHz the accessible area is limited to 1 cm².</p>					

Under **normal operating conditions**, **abnormal operating conditions** and **single fault conditions** (except for a **safeguard** fault), touch voltage or **touch current** shall be measured from all unearthed **accessible** conductive parts. **Touch current** (current^a and current^b of Table 4) shall be measured in accordance with 5.1.1 and 6.2.1 of IEC 60990:1999.

Under **single fault conditions** of a relevant **basic safeguard** or a **supplementary safeguard**, including 6.2.2.1 of IEC 60990:1999, touch voltage or **touch current** shall be measured from all unearthed **accessible** conductive parts. **Touch current** (current^b of Table 4) shall be measured with the network specified in Figure 5 of IEC 60990:1999.

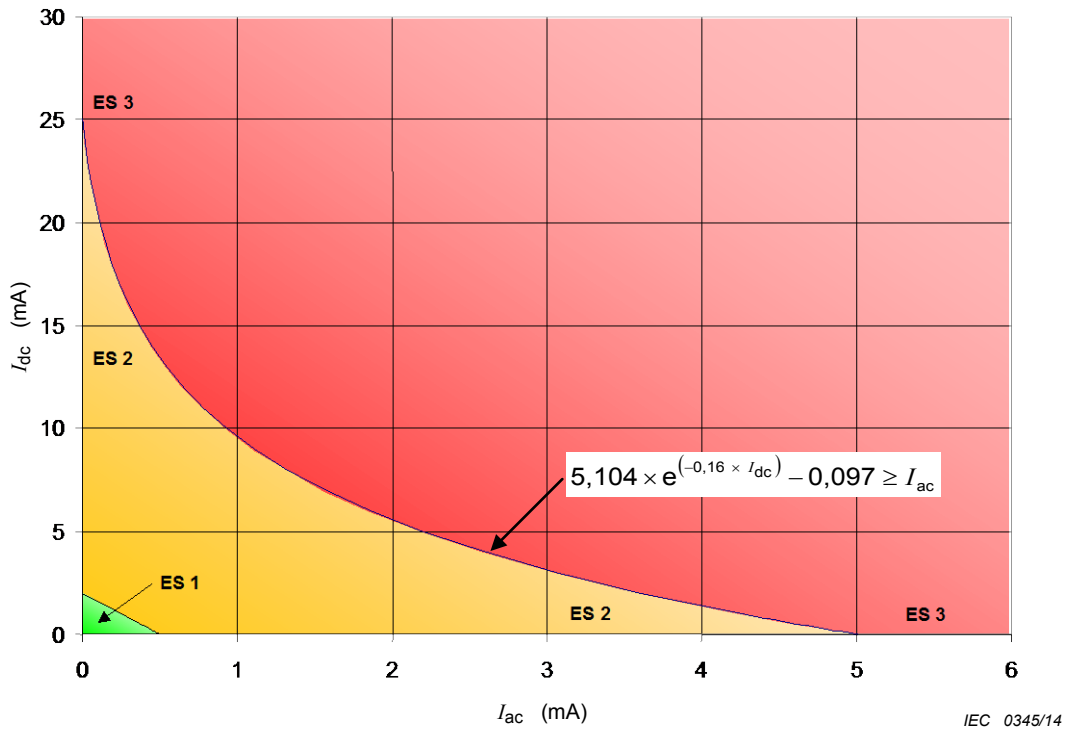

Figure 22 – Maximum values for combined a.c. current and d.c. current

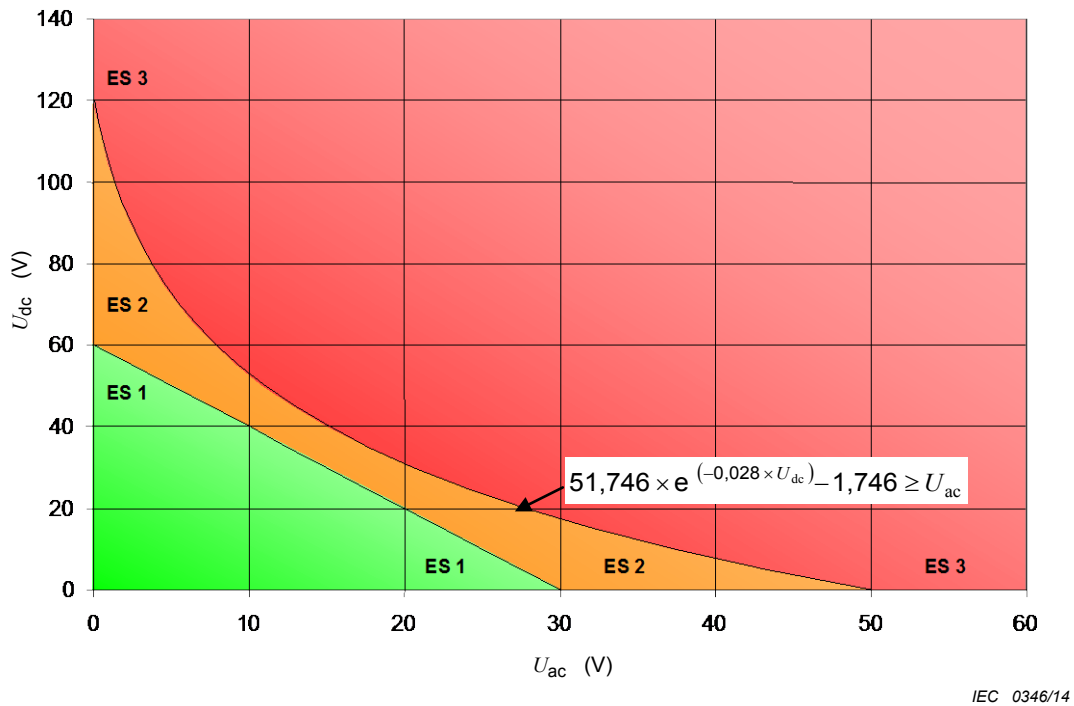

Figure 23 – Maximum values for combined a.c. voltage and d.c. voltage

5.2.2.3 Capacitance limits

Where the electrical energy source is a capacitor, the energy source is classified from both the charge voltage and the capacitance.

The capacitance is the rated value of the capacitor plus the specified tolerance.

The ES1 and ES2 limits for various capacitance values are listed in Table 5 .

NOTE 1 The capacitance values for ES2 are derived from Table A.2 of IEC/TS 61201:2007.

NOTE 2 The values for ES1 are calculated by dividing the values from Table A.2 of IEC/TS 61201:2007, by two (2).

Table 5 – Electrical energy source limits for a charged capacitor

C nF	ES1 U_{peak} V	ES2 U_{peak} V	ES3 U_{peak} V
300 or greater	60	120	> ES2
170	75	150	
91	100	200	
61	125	250	
41	150	300	
28	200	400	
18	250	500	
12	350	700	
8,0	500	1 000	
4,0	1 000	2 000	
1,6	2 500	5 000	
0,8	5 000	10 000	
0,4	10 000	20 000	
0,2	20 000	40 000	
0,133 or less	25 000	50 000	
Linear interpolation may be used between the nearest two points.			

5.2.2.4 Single pulse limits

Where the electrical energy source is a single pulse, the energy source is classified from both the voltage and the duration or from both the current and the duration. Values are given in Table 6 and Table 7. If the voltage exceeds the limit, then the current shall not exceed the limit. If the current exceeds the limit, the voltage shall not exceed the limit. Currents are measured according to 5.7. For repetitive pulses, see 5.2.2.5.

For pulse durations up to 10 ms, the voltage or current limit for 10 ms applies.

If more than one pulse is detected within a period of 3 s, then the electrical energy source is treated as a repetitive pulse and the limits of 5.2.2.5 apply.

NOTE 1 The pulse limits are calculated from IEC/TS 60479-1:2005, Figure 22 and Table 10.

NOTE 2 These single pulses do not include transients.

NOTE 3 Pulse duration is considered to be the time duration when the voltage or current exceeds ES1 limits.

Table 6 – Voltage limits for single pulses

Pulse duration up to and including ms	Electrical energy source level		
	ES1 U_{peak} V	ES2 U_{peak} V	ES3 U_{peak} V
10	60	196	> ES2
20		178	
50		150	
80		135	
100		129	
200 and longer		120	

If the time duration lies between the values in any two rows, the ES2 value of the U_{peak} in the row below shall be used or a linear interpolation may be used between any two adjacent rows with the calculated peak voltage value rounded down to the nearest volt.

If the peak voltage for ES2 lies between the values in any two rows, the value of the time duration in the row above may be used or a linear interpolation may be used between any two adjacent rows with the calculated time duration rounded down to the nearest millisecond.

Table 7 – Current limits for single pulses

Pulse duration up to and including ms	Electrical energy source level		
	ES1 I_{peak} mA	ES2 I_{peak} mA	ES3 I_{peak} mA
10	2	200	> ES2
20		153	
50		107	
100		81	
200		62	
500		43	
1 000		33	
2 000 and longer		25	

If the time duration lies between the values in any two rows, the ES2 value of the I_{peak} in the row below shall be used or a linear interpolation may be used between any two adjacent rows with the calculated value rounded down to the nearest milliamperere.

If the peak current for ES2 lies between the values in any two rows, the value of the time duration in the row above may be used or a linear interpolation may be used between any two adjacent rows with the calculated time duration rounded down to the nearest millisecond.

5.2.2.5 Limits for repetitive pulses

Except for pulses covered in Annex H, a repetitive pulse electrical energy source class is determined from either the available voltage or the available current (see Table 8). If the voltage exceeds the limit, then the current shall not exceed the limit. If the current exceeds the limit, the voltage shall not exceed the limit. Currents are measured according to 5.7.

Table 8 – Electrical energy source limits for repetitive pulses

Pulse off time		ES1	ES2	ES3
Less than 3 s	Current	0,707 mA peak	7,07 mA peak	> ES2
	Voltage	42,4 V peak	70,7 V peak	
3 s or more	Current	See 5.2.2.4	See 5.2.2.4	
	Voltage			

5.2.2.6 Ringing signals

Where the electrical energy source is an analogue telephone network ringing signal as defined in Annex H, the energy source class is considered ES2.

5.2.2.7 Audio signals

For electrical energy sources comprised of audio signals, see Clause E.1.

5.3 Protection against electrical energy sources

5.3.1 General

Except as given below, protection requirements for parts **accessible to ordinary persons, instructed persons, and skilled persons** are given in 4.3.

Bare conductors at ES3 shall be located or guarded so that unintentional contact with such conductors during service operations by a **skilled person** is unlikely (see Figure 19).

5.3.2 Accessibility to electrical energy sources and safeguards

5.3.2.1 Requirements

For **ordinary persons**, the following shall not be **accessible**:

- bare parts at ES2, except for the pins of connectors. However, such pins shall not be **accessible** under **normal operating conditions** by the blunt probe of Figure V.3; and
- bare parts at ES3; and
- an ES3 **basic safeguard**.

For **instructed persons**, the following shall not be **accessible**:

- bare parts at ES3; and
- an ES3 **basic safeguard**.

5.3.2.2 Contact requirements

For ES3 voltages up to 420 V peak, the appropriate test probe from Annex V shall not contact a bare internal conductive part.

For ES3 voltages above 420 V peak, the appropriate test probe from Annex V shall not contact a bare internal conductive part and shall have an air gap from that part (see Figure 24).

The air gap shall either:

- a) pass an electric strength test in accordance with 5.4.9.1 at a test voltage (d.c. or peak a.c.) that is equal to the test voltage for **basic insulation** in Table 27 corresponding to the **peak working voltage**; or

b) have a minimum distance according Table 9.

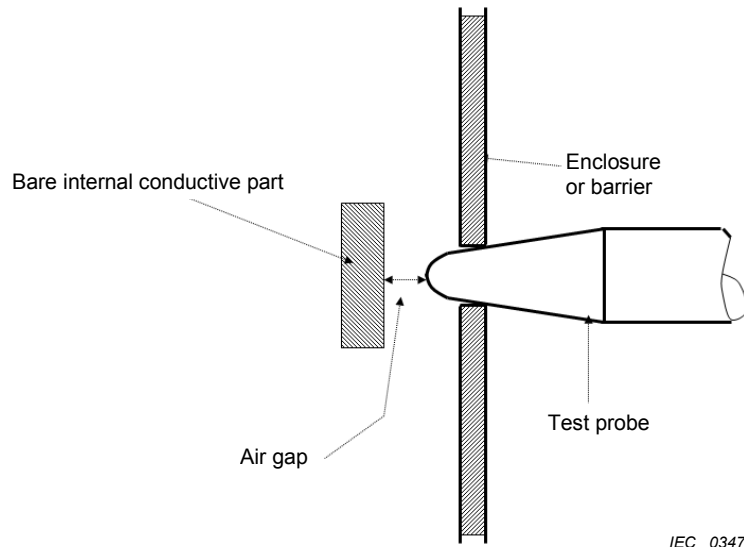

Figure 24 – Contact requirements to bare internal conductive parts

Table 9 – Minimum air gap distance

Peak working voltage V peak or d.c. up to and including	Air gap distance mm	
	Pollution degree	
	2	3
> 420 and ≤ 1 000	0,2	0,8
1 200	0,25	
1 500	0,5	
2 000	1,0	
2 500	1,5	
3 000	2,0	
4 000	3,0	
5 000	4,0	
6 000	5,5	
8 000	8,0	
10 000	11	
12 000	14	
15 000	18	
20 000	25	
25 000	33	
30 000	40	
40 000	60	
50 000	75	
60 000	90	
80 000	130	
100 000	170	

Linear interpolation may be used between the nearest two points, the calculated minimum air gap distance being rounded up to the next higher 0,1 mm increment or the value in the next row below whichever is lower.

5.3.2.3 Compliance criteria

Compliance is checked by the test of Clause T.3.

In addition, for bare ES3 parts at a voltage above 420 V peak, compliance is checked by distance measurement or by an electric strength test.

Components and subassemblies that comply with their respective IEC standards do not have to be tested when such components and subassemblies are used in the final product.

5.3.2.4 Terminals for connecting stripped wire

The use of a stripped wire to make connection with its associated terminal intended to be used by an **ordinary person** shall not result in contact with ES2 or ES3 (for audio signal voltages, see Table E.1 for values of ES2 and ES3). Parts of audio signal terminals provided with one of the **safeguards** in Table E.1 are not tested.

Compliance is checked by the test of V.1.6 for each wire terminal opening as well as any other openings within 25 mm from the terminal. During the test, no portion of the probe inserted into the terminal or opening shall contact ES2 or ES3.

5.4 Insulation materials and requirements

5.4.1 General

5.4.1.1 Insulation

Insulation consisting of insulating materials, **clearances**, **creepage distances** and **solid insulation**, and that is providing a **safeguard** function is designated **basic insulation**, **supplementary insulation**, **double insulation**, or **reinforced insulation**.

5.4.1.2 Properties of insulating material

The choice and application of insulating material shall take into account the needs for electrical strength, mechanical strength, dimension, frequency of the **working voltage** and other properties for the working environment (temperature, pressure, humidity and pollution) as specified in Clause 5 and Annex T.

Insulating material shall not be hygroscopic as determined by 5.4.1.3.

5.4.1.3 Compliance criteria

Compliance is checked by inspection and, where necessary, by evaluation of the data for the material.

Where necessary, if the data does not confirm that the material is non-hygroscopic, the hygroscopic nature of the material is determined by subjecting the component or subassembly using the insulation in question to the humidity treatment of 5.4.8. The insulation is then subjected to the relevant electric strength test of 5.4.9.1 while still in the humidity chamber, or in the room in which the samples were brought to the prescribed temperature.

5.4.1.4 Maximum operating temperatures for materials, components and systems

5.4.1.4.1 Requirements

Under **normal operating conditions**, insulating material temperatures shall not exceed the temperature limit of the EIS, including insulating materials of components, or the maximum temperature limit of the insulation system as given in Table 10.

For maximum temperatures below or equal to 100 °C, no declared insulation system is required. An undeclared EIS is considered to be class 105.

5.4.1.4.2 Test method

Insulating material temperatures are measured in accordance with B.1.6.

*The equipment or parts of the equipment are operated under **normal operating conditions** (see Clause B.2) as follows:*

- for continuous operation, until steady state conditions are established; and*
- for **intermittent operation**, until steady state conditions are established, using the rated "ON" and "OFF" periods; and*
- for **short-time operation**, for the operating time specified by the manufacturer.*

Components and other parts may be tested independently of the end product provided that the test conditions applicable to the end product are applied to the component or part.

Equipment intended for building-in or rack-mounting, or for incorporation in larger equipment, is tested under the most adverse actual or simulated conditions specified in the installation instructions.

5.4.1.4.3 Compliance criteria

The temperature of the electrical insulation material or EIS shall not exceed the limits in Table 10.

For a single insulating material, the declared relative temperature index information from the material manufacturer can be used if it is suitable for the applicable class of insulation

For an EIS, the available thermal class data of the EIS as indicated by the manufacturer can be used if it is suitable for the applicable class of insulation.

For thermal classifications above Class 105, the EIS shall comply with IEC 60085.

Table 10 – Temperature limits for materials, components and systems

Part	Maximum temperature T_{max} °C
Insulation, including winding insulation:	
of Class 105 (A) material or EIS	100 ^a
of Class 120 (E) material or EIS	115 ^a
of Class 130 (B) material or EIS	120 ^a
of Class 155 (F) material or EIS	140 ^a
of Class 180 (H) material or EIS	165 ^a
of Class 200 (N) material or EIS	180 ^a
of Class 220 (R) material or EIS	200 ^a
of Class 250 material or EIS	225 ^a
Insulation of internal and external wiring, including power supply cords:	
– without temperature marking	70
– with temperature marking	Temperature marked on the wire or spool, or rating assigned by the manufacturer
Other thermoplastic insulation	See 5.4.1.10
Components	See also Annex G and 4.1.2
<p>The classes are related to the temperature classes of electrical insulating materials and EIS in accordance with IEC 60085. The assigned letter designations are given in parentheses.</p> <p>For each material, account shall be taken of the data for that material to determine the appropriate maximum temperature.</p> <p>^a If the temperature of a winding is determined by thermocouples, these values are reduced by 10 K, except in the case of:</p> <p>a motor, or</p> <p>a winding with embedded thermocouples.</p>	

5.4.1.5 Pollution degrees

5.4.1.5.1 General

The different degrees of pollution of the operating or micro-environment for products covered by this standard are given below.

Pollution degree 1

No pollution or only dry, non-conductive pollution occurs. The pollution has no influence.

NOTE 1 Within the equipment, components or subassemblies that are sealed to exclude dust and moisture are examples of **pollution degree 1**.

Pollution degree 2

Only non-conductive pollution occurs except that occasionally a temporary conductivity caused by condensation is to be expected.

NOTE 2 **Pollution degree 2** is generally appropriate for equipment covered by the scope of this standard.

Pollution degree 3

Conductive pollution occurs or dry non-conductive pollution occurs that becomes conductive due to condensation, which is to be expected.

5.4.1.5.2 Test for pollution degree 1 environment and for an insulating compound

A sample is subjected to the thermal cycling sequence of 5.4.1.5.3.

It is allowed to cool to room temperature and is then subjected to the humidity conditioning of 5.4.8.

*If the test is conducted for verification of the insulating compound forming **solid insulation** as required by 5.4.4.3, the conditioning is immediately followed by the electric strength test of 5.4.9.1.*

*For printed boards, compliance is checked by external visual inspection. There shall be no delamination which affects the **creepage distances** required to fulfil the requirements of **pollution degree 1**.*

For other than printed boards, compliance is checked by inspection of the cross-sectional area, and there shall be no visible voids, gaps or cracks in the insulating material.

5.4.1.5.3 Thermal cycling test procedure

A sample of a component or subassembly is subjected to the following sequence of tests. The sample is subjected 10 times to the following sequence of thermal cycling:

68 h	at	$(T_1 \pm 2) \text{ }^\circ\text{C}$;
1 h	at	$(25 \pm 2) \text{ }^\circ\text{C}$;
2 h	at	$(0 \pm 2) \text{ }^\circ\text{C}$;
$\geq 1 \text{ h}$	at	$(25 \pm 2) \text{ }^\circ\text{C}$.

$T_1 = T_2 + T_{\text{ma}} - T_{\text{amb}} + 10 \text{ K}$, measured in accordance with B.1.6, or $85 \text{ }^\circ\text{C}$, whichever is higher. However, the 10 K margin is not added if the temperature is measured by an embedded thermocouple or by the resistance method.

T_2 is the temperature of the parts measured during the test of 5.4.1.4.

The significance of T_{ma} and T_{amb} are as given in B.2.6.1.

The period of time taken for the transition from one temperature to another is not specified, but the transition may be gradual.

5.4.1.6 Insulation in transformers with varying dimensions

If the insulation of a transformer has different **working voltages** along the length of the winding, the **clearances**, **creepage distances** and distances through insulation may vary in a corresponding fashion.

NOTE An example of such a construction is a 30 kV winding, consisting of multiple bobbins connected in series, and earthed or connected to a common point at one end.

5.4.1.7 Insulation in circuits generating starting pulses

For circuits generating starting pulses exceeding ES1 (for example, to ignite a discharge lamp), the requirements for **basic insulation**, **supplementary insulation** and **reinforced insulation** apply to **creepage distances** and distances through insulation.

NOTE 1 For **working voltages** in the above cases, see 5.4.1.8.1 i).

NOTE 2 If the starting pulse is an a.c. waveform, the pulse width is determined by connecting the peak values of the a.c. waveform.

The **clearances** are determined by one of the following methods:

- determine the minimum **clearance** in accordance with 5.4.2; or
- conduct one of the following electric strength tests, with the connection terminals of the starting pulse circuit (for example, a lamp) shorted together:
 - the test given in 5.4.9.1, or
 - apply 30 pulses having an amplitude equal to the required test voltage given in 5.4.9.1 generated by an external pulse generator. The pulse width shall be equal to or greater than that of the internally generated starting pulse.

Compliance is checked by inspection or test. During the test, the insulation shall show no breakdown or flashover.

5.4.1.8 Determination of working voltage

5.4.1.8.1 General

In determining **working voltages**, all of the following requirements apply:

- a) unearthed **accessible** conductive parts are assumed to be earthed;
- b) if a transformer winding or other part is not connected to a circuit that establishes its potential relative to earth, the winding or other part are assumed to be earthed at a point by which the highest **working voltage** is obtained;
- c) except as specified in 5.4.1.6, for insulation between two transformer windings, the highest voltage between any two points in the two windings is the **working voltage**, taking into account the voltages to which the input windings will be connected;
- d) except as specified in 5.4.1.6, for insulation between a transformer winding and another part, the highest voltage between any point on the winding and the other part is the **working voltage**;
- e) where **double insulation** is used, the **working voltage** across the **basic insulation** is determined by imagining a short-circuit across the **supplementary insulation**, and vice versa. For **double insulation** between transformer windings, the short-circuit is assumed to take place at the point by which the highest **working voltage** is produced across the other insulation;
- f) when the **working voltage** is determined by measurement, the input power supplied to the equipment shall be the **rated voltage** or the voltage within the **rated voltage range** that results in the highest measured value;
- g) the **working voltage** between
 - any point in the circuit supplied by the **mains** and any part connected to earth; and
 - any point in the circuit supplied by the **mains** and any point in a circuit isolated from the **mains**,shall be assumed to be the greater of the following:
 - the **rated voltage** or the upper voltage of the **rated voltage range**; and
 - the measured voltage;

- h) when determining the **working voltage** for an ES1 or ES2 **external circuit**, the normal operating voltages shall be taken into account. If the operating voltages are not known, the **working voltage** shall be taken as the upper limits of ES1 or ES2 as applicable. Short duration signals (such as telephone ringing) shall not be taken into account for determining **working voltage**;
- i) for circuits generating starting pulses (for example, discharge lamps, see 5.4.1.7), the **peak working voltage** is the peak value of the pulses with the lamp connected but before the lamp ignites. The frequency of the **working voltage** to determine the minimum clearance may be assumed to be less than 30 kHz. The **working voltage** to determine minimum **creepage distances** is the voltage measured after the ignition of the lamp; and
- j) **temporary overvoltages** and recurring peak voltages have to be considered.

5.4.1.8.2 RMS working voltage

In determining the **r.m.s. working voltage**, short-term conditions (for example, cadenced telephone ringing signals in **external circuits**) and non-repetitive transients (for example, due to atmospheric disturbances) are not taken into account.

NOTE The **creepage distances** are determined from the **r.m.s. working voltages**.

5.4.1.8.3 Peak working voltage

For the **peak working voltage** used to determine the **required withstand voltage** for minimum **clearances** and test voltages for electric strength:

- when determining the **peak working voltage** between circuits connected to the **mains** and circuits isolated from the **mains**, the voltage of any ES2 circuit, ES1 circuit or **external circuits** (including telephone ringing signals) shall be regarded as 0;
- when determining the **peak working voltage** for an **external circuit** that does not have transients, the **peak working voltage** of repetitive signals, such as telephone ringing signals, shall be taken into account;
- non-repetitive transients (for example, due to atmospheric disturbances) shall not be taken into account.

5.4.1.9 Insulating surfaces

An **accessible** insulating surface is considered to be covered by a thin metallic foil for determining **clearances**, **creepage distances** and distance through insulation (see Figure O.13).

5.4.1.10 Thermoplastic parts on which conductive metallic parts are directly mounted

5.4.1.10.1 Requirements

Thermoplastic parts on which conductive metallic parts are directly mounted shall be sufficiently resistant to heat if softening of the plastic could result in the failure of a **safeguard**.

5.4.1.10.2 Compliance criteria

Compliance is checked by examination of the Vicat test data from the material manufacturer. If the data is not available, compliance is checked by either the Vicat test given below or by the ball pressure test of 5.4.1.10.3.

*The measured temperature during **normal operating conditions**, as specified in Clause B.2, shall be at least 15 K less than the Vicat softening temperature as specified in Vicat test B50 of ISO 306.*

*The measured temperature during **abnormal operating conditions** of Clause B.3 shall be less than the Vicat softening temperature.*

The Vicat softening temperature of a non-metallic part supporting parts in a circuit supplied from the **mains** shall be not less than 125 °C.

5.4.1.10.3 Ball pressure test

Compliance is checked by examination of the ball pressure test data from the manufacturer or by subjecting the part to the ball pressure test according to IEC 60695-10-2. The test is made in a heating cabinet at a temperature of $(T - T_{amb} + T_{ma} + 15 \text{ °C}) \pm 2 \text{ °C}$ (see B.2.6.1 for the explanation of T , T_{ma} and T_{amb}). However, a thermoplastic part supporting parts in a circuit supplied from the **mains** is tested at a minimum of 125 °C.

After the test, dimension d (diameter of the indentation) shall not exceed 2 mm.

The test is not made if it is clear from examination of the physical characteristics of the material that it will meet the requirements of this test.

5.4.2 Clearances

5.4.2.1 General requirements

Clearances shall be so dimensioned that the likelihood of breakdown due to

- **temporary overvoltages**, and
- transient voltages that may enter the equipment, and
- **peak working voltages** that are generated within the equipment, and
- frequencies that are generated within the equipment

is reduced.

All required **clearances** and test voltages apply to an altitude up to 2 000 m. For higher altitudes, the multiplication factors of 5.4.2.5 apply.

NOTE For air gaps between contacts of **safety interlocks**, see Annex K. For air gaps between contacts of **disconnect devices**, see Annex L. For air gaps between contacts in components, see Annex G. For connectors, see G.4.1.

Unless otherwise specified by the manufacturer and supplied with means to assure minimum **clearances** during all modes of normal operation, the voice coil and adjacent conductive parts of a loudspeaker are considered to be conductively connected.

To determine the **clearance**, the highest value of the following two procedures shall be used:

Procedure 1: Determine **clearances** according to 5.4.2.2 using the **peak working voltage**.

Procedure 2: Determine **clearances** according to 5.4.2.3 using the **required withstand voltages**. Alternatively, the adequacy of **clearances** may be determined using an electric strength test according to 5.4.2.4, in which case the values according to procedure 1 shall be maintained.

5.4.2.2 Procedure for determining clearance using peak working voltage

To determine the **peak working voltage**, the highest voltage of the following is taken into account as applicable:

- steady state voltages; and
- recurring peak voltages to be taken as 1,1 times the **mains** voltage (see 5.3.3.2.4 of IEC 60664-1:2007); and

- **temporary overvoltages** as given below (see also 5.3.3.2.3 of IEC 60664-1:2007).

The **temporary overvoltage** value is taken as 2 000 V peak if the nominal **mains** system voltage does not exceed 250 V and is taken as 2 500 V peak if the nominal **mains** system voltage exceeds 250 V but does not exceed 600 V.

Alternatively, the **temporary overvoltage** may be determined in accordance with 5.3.3.2.3 of IEC 60664-1:2007 at the discretion of the manufacturer.

The highest value of the **clearance** determined as given below shall be used:

- **clearance** values of Table 11 for circuits with fundamental frequencies up to 30 kHz;
- **clearance** values of Table 12 for circuits with fundamental frequencies higher than 30 kHz; or
- the highest **clearance** values of Table 11 and Table 12 for circuits where both frequencies lower than 30 kHz and higher than 30 kHz are present.

Table 11 – Minimum clearances for voltages with frequencies up to 30 kHz

Peak working voltage or d.c. up to and including	Basic insulation or supplementary insulation mm			Reinforced insulation mm		
	Pollution degree			Pollution degree		
	1 ^a	2	3	1 ^a	2	3
330	0,01	0,2	0,8	0,02	0,4	1,5
400	0,02					
500	0,04					
600	0,06					
800	0,13					
1 000	0,26	0,26		0,52	0,52	
1 200	0,42			0,84		
1 500	0,76			1,52		1,6
2 000	1,27			2,54		
2 500	1,8			3,6		
3 000	2,4			4,8		
4 000	3,8			7,6		
5 000	5,7			11,0		
6 000	7,9			15,8		
8 000	11,0			20		
10 000	15,2			27		
12 000	19			33		
15 000	25			42		
20 000	34			59		
25 000	44			77		
30 000	55			95		
40 000	77			131		
50 000	100			175		
60 000	120			219		
80 000	175			307		
100 000	230			395		
<p>Linear interpolation may be used between the nearest two points, the calculated minimum clearances being rounded up to the next higher specified increment or the value in the next row below whichever is lower. For values:</p> <ul style="list-style-type: none"> – not exceeding 0,5 mm, the specified increment is 0,01 mm; and – exceeding 0,5 mm, the specified increment is 0,1 mm. 						
<p>^a The values for pollution degree 1 may be used if a sample complies with the tests of 5.4.1.5.2.</p>						

Table 12 – Minimum clearances for voltages with frequencies above 30 kHz

Peak working voltage up to and including	Basic insulation or supplementary insulation mm	Reinforced insulation mm
600	0,07	0,14
800	0,22	0,44
1 000	0,6	1,2
1 200	1,68	3,36
1 400	2,82	5,64
1 600	4,8	9,6
1 800	8,04	16,08
2 000	13,2	26,4

Linear interpolation may be used between the nearest two points, the calculated minimum **clearances** being rounded up to the next higher specified increment or the value in the next row below whichever is lower. For values:

- not exceeding 0,5 mm, the specified increment is 0,01 mm; and
- exceeding 0,5 mm, the specified increment is 0,1 mm.

For **pollution degree** 1, use a multiplication factor of 0,8.

For **pollution degree** 3, use a multiplication factor of 1,4.

5.4.2.3 Procedure for determining clearance using required withstand voltage

5.4.2.3.1 General

The dimension for a **clearance** that is subject to transient voltages from the **mains** or an **external circuit** is determined from the **required withstand voltage** for that **clearance**.

Each **clearance** shall be determined using the following steps:

- Determine the transient voltage according to 5.4.2.3.2; and
- Determine the **required withstand voltage** according to 5.4.2.3.3; and
- Determine the minimum **clearance** according to 5.4.2.3.4.

5.4.2.3.2 Determining transient voltages

5.4.2.3.2.1 General

Transient voltages can be determined based on their origin, or can be measured in accordance with 5.4.2.3.2.5.

If different transient voltages affect the same **clearance**, the largest of those voltages is used. The values are not added together.

5.4.2.3.2.2 Determining a.c. mains transient voltages

For equipment to be supplied from the a.c. **mains**, the value of the **mains transient voltage** depends on the overvoltage category and the a.c. **mains** voltage and is given in Table 13. In general, **clearances** in equipment intended to be connected to the a.c. **mains**, shall be designed for overvoltage category II.

NOTE See Annex I for further guidance on the determination of overvoltage categories.

Equipment that is likely, when installed, to be subjected to transient voltages that exceed those for its design overvoltage category requires additional transient voltage protection to be provided external to the equipment. In this case, the installation instructions shall state the need for such external protection.

Table 13 – Mains transient voltages

AC mains voltage ^a up to and including V r.m.s.	Mains transient voltage ^b V peak			
	Overvoltage category			
	I	II	III	IV
50	330	500	800	1 500
100 ^c	500	800	1 500	2 500
150 ^d	800	1 500	2 500	4 000
300 ^e	1 500	2 500	4 000	6 000
600 ^f	2 500	4 000	6 000	8 000

^a For equipment designed to be connected to a three-phase 3-wire supply, where there is no neutral conductor, the a.c. **mains** supply voltage is the line-to-line voltage. In all other cases, where there is a neutral conductor, it is the line-to-neutral voltage.

^b The **mains transient voltage** is always one of the values in the table. Interpolation is not permitted.

^c In Japan, the value of the **mains transient voltages** for the nominal a.c. **mains** supply voltage of 100 V is determined from columns applicable to the nominal a.c. **mains** supply voltage of 150 V.

^d Including 120/208 V and 120/240 V.

^e Including 230/400 V and 277/480 V.

^f Including 400/690 V.

5.4.2.3.2.3 Determining d.c. mains transient voltages

If an earthed d.c. power distribution system is entirely within a single building, the transient voltage is selected as follows:

- if the d.c. power distribution system is earthed at a single point, the transient voltage is taken to be 500 V peak; or
- if the d.c. power distribution system is earthed at the source and the equipment, the transient voltage is taken to be 350 V peak; or

NOTE The connection to protective earth can be at the source of the d.c. power distribution system or at the equipment location, or both (see ITU-T Recommendation K.27).

- if the cabling associated with the d.c. power distribution system is shorter than 4 m or is installed entirely in continuous metallic conduit, the transient voltage is taken to be 150 V peak.

If a d.c. power distribution system is not earthed or is not within the same building, the transient voltage with respect to earth shall be taken to be equal to the **mains transient voltage** in the **mains** from which the d.c. power is derived.

If the d.c. power distribution system is not within the same building, and is constructed using installation and protection techniques similar to those of **external circuits**, the transient voltage shall be determined using the relevant classification from 5.4.2.3.2.4.

If equipment is supplied from a dedicated **battery** that has no provision for charging from a **mains** supply without removal from the equipment, the transient voltage shall be disregarded.

5.4.2.3.2.4 Determining external circuit transient voltages

The applicable value of the transient voltage that may occur on an **external circuit** shall be determined using Table 14. Where more than one location or condition is applicable, the highest transient voltage applies. A ringing or other interrupted signal shall not be taken into account if the voltage of this signal is less than that of the transient voltage.

If the transient voltage is less than the peak voltage of a short duration signal (such as a telephone ringing signal), the peak voltage of the short duration signal shall be used as the transient voltage.

If the **external circuit** transient voltages are known to be higher than indicated in Table 14, the known value shall be used.

NOTE 1 Australia has published its overvoltage limits in AS/ACIF G624:2005.

NOTE 2 It is assumed that adequate measures have been taken to reduce the likelihood that the transient voltages presented to the equipment exceed the values specified in Table 14. In installations where transient voltages presented to the equipment are expected to exceed the values specified in Table 14, additional measures such as surge suppression can be necessary.

NOTE 3 In Europe the requirement for interconnection with **external circuit** is in addition given in EN 50491-3:2009, *General requirements for Home and Building Electronic Systems (HBES) and Building Automation and Control Systems (BACS) – Part 3: Electrical safety requirements*.

Table 14 – External circuit transient voltages

ID	Cable type	Additional conditions	Transient voltages
1	Paired conductor ^a – shielded or unshielded	The building or structure may or may not have equipotential bonding	1 500 V 10/700 μs Only differential if one conductor is earthed in the equipment
2	Any other conductors	The external circuit is not earthed at either end, but there is an earth reference (for example, from connection to mains)	Mains transient voltage or external circuit transient voltage of the circuit from which the circuit in question is derived whichever is higher
3	Coaxial cable in the cable distribution network	Equipment other than power-fed coaxial repeaters. Cable shield is earthed at the equipment	4 000 V 10/700 μs Centre conductor to shield
4	Coaxial cable in the cable distribution network	Power fed coaxial repeaters (up to 4,4 mm coaxial cable). Cable shield is earthed at the equipment	5 000 V 10/700 μs Centre conductor to shield
5	Coaxial cable in the cable distribution network	Equipment other than power-fed coaxial repeaters. Cable shield is not earthed at the equipment. Cable shield is earthed at building entrance	4 000 V 10/700 μs Centre conductor to shield 1 500 V 1,2/50 μs shield to earth
6	Coaxial cable	Cable connects to an outdoor antenna	no transient, see ^c
7	Paired conductor ^a	Cable connects to an outdoor antenna	no transient, see ^c
8	Coaxial cable within the building ^b	The connection of the cable coming from outside the building is made via a transfer point. The shield of the coaxial cable from outside the building and the shield of the coaxial cable of the cable within the building are connected together and are connected to earth.	Not applicable

In general, for **external circuits** installed wholly within the same building structure, transients are not taken into account. However, a conductor is considered to leave the building if it terminates on equipment earthed to a different earthing network.

The effects of unwanted steady-state voltages generated outside the equipment (for example, earth potential differences and voltages induced on telecommunication networks by electric train systems) are controlled by installation practices. Such practices are application dependent and are not dealt with by this standard.

For a shielded cable to affect a reduction in transients, the shield shall be continuous, earthed at both ends, and have a maximum transfer impedance of 20 Ω/km (for f less than 1 MHz).

NOTE 1 Home appliances like audio, video and multimedia products are addressed by ID 6, 7 and 8.

NOTE 2 In Norway and Sweden, the cable shield on coaxial cables is normally not earthed at the building entrance (see the note in 5.7.6). For installation conditions, see EN 60728-11.

^a A paired conductor includes a twisted pair.

^b When determining the separation requirements in 5.4.10, the transients on **external circuits** are taken into account.

^c These cables are not subject to any transients but they may be affected by a 10 kV electrostatic discharge voltage (from a 1 nF capacitor). The effect of such electrostatic discharge voltages is not taken into account when determining **clearances**. Compliance is checked by the test of G.10.3.2.

5.4.2.3.2.5 Determining transient voltage levels by measurement

The transient voltage across the **clearance** is measured using the following procedure.

During the measurement, the equipment is not connected to the **mains**, to the external d.c. power distribution system or to any **external circuit**. Any surge suppressors internal to the equipment in circuits connected to the **mains** or the external d.c. power distribution system are disconnected. If the equipment is intended to be used with a separate power supply, it is connected to the equipment during the measurement.

To measure the transient voltage across a **clearance**, the appropriate impulse test generator of Annex D is used to generate impulses. At least three impulses of each polarity, with intervals of at least 1 s between impulses, are applied between each of the relevant points.

a) Transient voltages from an a.c. **mains**

The impulse test generator circuit 2 of Table D.1 is used to generate 1,2/50 μ s impulses equal to the a.c. **mains transient voltages**, at the following points:

- line-to-line;
- all line conductors conductively joined together and neutral;
- all line conductors conductively joined together and protective earth; and
- neutral and protective earth.

b) Transient voltages from a d.c. **mains**

The impulse test generator circuit 2 of Table D.1 is used to generate 1,2/50 μ s impulses equal to the d.c. **mains transient voltages**, at the following points:

- the positive and negative supply connection points; and
- all supply connection points joined together and protective earth.

c) Transient voltages from an **external circuit**

The appropriate test generator of Annex D is used to generate impulses as applicable and described in Table 14 and are applied between each of the following **external circuit** connection points of a single interface type:

- each pair of terminals (for example, A and B or tip and ring) in an interface; and
- all terminals of a single interface type joined together and earth.

A voltage measuring device is connected across the **clearance** in question.

Where there are several identical circuits, only one is tested.

5.4.2.3.3 Determining required withstand voltage

The **required withstand voltage** is equal to the transient voltage as determined in 5.4.2.3.2, except for the following cases:

- If a circuit isolated from the **mains** is connected to a main protective earthing terminal that complies with 5.6.7, the **required withstand voltage** may be one overvoltage category lower in Table 13.
- In a circuit isolated from the **mains** supplied by a d.c. source with capacitive filtering, and connected to protective earth, the **required withstand voltage** shall be assumed to be equal to the peak value of the **d.c. voltage** of the source, or the **peak working voltage** of the circuit isolated from the **mains**, whichever is higher.
- If equipment is supplied from a dedicated **battery** that has no provision for charging from the **mains** supply without removal from the equipment, the transient voltage is zero and the **required withstand voltage** is equal to the **peak working voltage**.

5.4.2.3.4 Determining clearances using required withstand voltage

Each **clearance** shall comply with the relevant value of Table 15.

Table 15 – Minimum clearances using required withstand voltage

Required withstand voltage	Basic insulation or supplementary insulation mm			Reinforced insulation mm		
	Pollution degree			Pollution degree		
V peak or d.c. up to and including	1 ^a	2	3	1 ^a	2	3
330	0,01	0,2	0,8	0,02	0,4	1,5
400	0,02			0,04		
500	0,04			0,08		
600	0,06			0,12		
800	0,10			0,2		
1 000	0,15			0,3		
1 200	0,25			0,5		
1 500	0,5			1,0		
2 000	1,0			2,0		
2 500	1,5			3,0		
3 000	2,0			3,8		
4 000	3,0			5,5		
5 000	4,0			8,0		
6 000	5,5			8,0		
8 000	8,0			14		
10 000	11			19		
12 000	14			24		
15 000	18			31		
20 000	25			44		
25 000	33			60		
30 000	40			72		
40 000	60			98		
50 000	75			130		
60 000	90			162		
80 000	130			226		
100 000	170			290		
<p>Linear interpolation may be used between the nearest two points, the calculated minimum clearances being rounded up to the next higher specified increment or the value in the next row below whichever is lower. For values:</p> <ul style="list-style-type: none"> – not exceeding 0,5 mm, the specified increment is 0,01 mm; and – exceeding 0,5 mm, the specified increment is 0,1 mm. 						
^a The values for pollution degree 1 may be used if a sample complies with the tests of 5.4.1.5.2.						

5.4.2.4 Determining the adequacy of a clearance using an electric strength test

The **clearances** shall withstand an electric strength test. The test may be conducted using an impulse voltage or an a.c. voltage or a d.c. voltage. The **required withstand voltage** is determined as given in 5.4.2.3.

The impulse withstand voltage test is carried out with a voltage having an appropriate waveform (see Annex D) with the values specified in Table 16. Five impulses of each polarity are applied with an interval of at least 1 s between pulses.

The *a.c. voltage test* is conducted using a sinusoidal voltage with a peak value as specified in Table 16 and is applied for 5 s.

The *d.c. voltage test* is conducted using a *d.c. voltage* specified in Table 16 and applied for 5 s in one polarity and then for 5 s in reverse polarity.

Table 16 – Electric strength test voltages

Required withstand voltage up to and including kV peak	Test voltage for electric strength for clearances for basic insulation or supplementary insulation kV peak (impulse or a.c. or d.c.)
0,33	0,36
0,5	0,54
0,8	0,93
1,5	1,75
2,5	2,92
4,0	4,92
6,0	7,39
8,0	9,85
12,0	14,77
U^a	$1,23 \times U^a$

Linear interpolation may be used between the nearest two points, the calculated minimum test voltage being rounded up to the next higher 0,01 kV increment.

For **reinforced insulation**, the test voltage for electric strength is 160 % of the value for the **basic insulation**.

If the EUT fails the a.c. or d.c. test, the impulse test shall be used.

If the test is conducted at an altitude of 200 m or more above sea level, Table F.5 of IEC 60664-1:2007 may be used.

^a U is any **required withstand voltage** higher than 12,0 kV.

5.4.2.5 Multiplication factors for altitudes higher than 2 000 m above sea level

For equipment intended to be used more than 2 000 m above sea level, the minimum **clearances** in Table 11, Table 12 and Table 15 and the electric strength test voltages in Table 16 are multiplied by the applicable multiplication factor for the desired altitude according to Table 17.

NOTE 1 Higher altitudes can be simulated in a vacuum chamber.

NOTE 2 In China, special requirements in choosing multiplication factors for altitudes above 2 000 m exist.

Table 17 – Multiplication factors for clearances and test voltages

Altitude m	Normal barometric pressure kPa	Multiplication factor for clearances	Multiplication factor for electric strength test voltages		
			< 1 mm	≥ 1 mm to < 10 mm	≥ 10 mm to < 100 mm
2 000	80,0	1,00	1,00	1,00	1,00
3 000	70,0	1,14	1,05	1,07	1,10
4 000	62,0	1,29	1,10	1,15	1,20
5 000	54,0	1,48	1,16	1,24	1,33

Linear interpolation may be used between the nearest two points, the calculated minimum multiplication factor being rounded up to the next higher 0,01 increment.

5.4.2.6 Compliance criteria

Compliance is checked by measurement and test taking into account the relevant clauses of Annex O and Annex T.

The following conditions apply:

- *movable parts are placed in their most unfavourable positions;*
- ***clearances** from an **enclosure** of insulating material through a slot or opening are measured according to Figure O.13, point X;*
- *during the force tests, metal **enclosures** shall not come into contact with bare conductive parts of:*
 - *ES2 circuits, unless the product is in a **restricted access area**, or*
 - *ES3 circuits;*
- *after the tests of Annex T, the dimensions for **clearances** are measured;*
- *after the tests of Annex T, the electric strength test shall be applied;*
- *for the impact test of Clause T.9, damage to the finish, small dents that do not reduce **clearances** below the specified values, surface cracks and the like are ignored. If a through crack appears, **clearances** shall not be reduced. For cracks not visible to the naked eye, an electric strength test shall be conducted; and*
- *components and parts, other than parts serving as an **enclosure**, are subjected to the test of Clause T.2. After the application of the force, **clearances** shall not be reduced below the required values.*

For circuits connected to coaxial cable distribution or outdoor antennas, compliance is checked by the tests of 5.5.8.

5.4.3 Creepage distances

5.4.3.1 General

Creepage distances shall be so dimensioned that, for a given **r.m.s. working voltage**, **pollution degree** and material group, no flashover or breakdown of insulation (for example, due to tracking) will occur.

Creepage distances for **basic insulation** and **supplementary insulation** for frequencies up to 30 kHz shall comply with Table 18. **Creepage distances** for **basic insulation** and **supplementary insulation** for frequencies greater than 30 kHz and up to 400 kHz shall comply with Table 19.

The **creepage distance** requirements for frequencies up to 400 kHz can be used for frequencies over 400 kHz until additional data is available.

NOTE 1 **Creepage distances** for frequencies higher than 400 kHz are under consideration.

The **creepage distance** between the outer insulating surface (see 5.4.3.2) of a connector (including an opening in the **enclosure**) and conductive parts that are connected to ES2 within the connector (or in the **enclosure**) shall comply with the requirements for **basic insulation**.

The **creepage distance** between the outer insulating surface (see 5.4.3.2) of a connector (including an opening in the **enclosure**) and conductive parts that are connected to ES3 within the connector (or in the **enclosure**) shall comply with the requirements for **reinforced insulation**.

As an exception, the **creepage distance** may comply with the requirements for **basic insulation** if the connector is:

- fixed to the equipment; and
- located internally to the outer **electrical enclosure** of the equipment; and
- only **accessible** after removal of a subassembly that
 - is required to be in place during **normal operating conditions**, and
 - is provided with an **instructional safeguard** to replace the removed subassembly.

NOTE 2 The tests of 5.4 apply to such connectors after removal of the subassembly.

For all other **creepage distances** in connectors, including connectors that are not fixed to the equipment, the minimum values determined in accordance with 5.4.3 apply.

The above minimum **creepage distances** for connectors do not apply to connectors listed in Clause G.4.

NOTE 3 For **creepage distances** below 2 mm, additional information is available in IEC 60664-5.

*If the minimum **creepage distance** derived from Table 18 or Table 19 is less than the minimum **clearance**, then the minimum **clearance** shall be applied as the minimum **creepage distance**.*

*For glass, mica, glazed ceramic or similar inorganic materials, if the minimum **creepage distance** is greater than the applicable minimum **clearance**, the value of minimum **clearance** may be applied as the minimum **creepage distance**.*

*For **reinforced insulation**, the values for **creepage distances** are twice the values for **basic insulation** in Table 18 or Table 19.*

5.4.3.2 Test method

The following conditions apply:

- *movable parts are placed in their most unfavourable positions;*
- *for equipment incorporating ordinary **non-detachable power supply cords**, **creepage distance** measurements are made with supply conductors of the largest cross-sectional area specified in Clause G.7, and also without conductors;*
- *when measuring **creepage distances** from an **accessible** outer surface of an **enclosure** of insulating material through a slot or opening in the **enclosure** or through an opening in an **accessible** connector, the **accessible** outer surface of the **enclosure** shall be considered to be conductive as if it were covered by a metal foil during the test of V.1.2, applied without appreciable force (see Figure O.13, point X);*
- *the dimensions for **creepage distances** functioning as **basic insulation**, **supplementary insulation** and **reinforced insulation** are measured after the tests of Annex T according to 4.4.4;*
- *for the glass breakage test of Clause T.9, damage to the finish, small dents that do not reduce **creepage distances** below the specified values, surface cracks and the like are ignored. If a through crack appears, **creepage distances** shall not be reduced;*
- *components and parts, other than parts serving as an **enclosure**, are subjected to the test of Clause T.2. After the application of the force, **creepage distances** shall not be reduced below the required values.*

5.4.3.3 Material group and CTI

Material groups are based on the CTI and are classified as follows:

Material Group I	$600 \leq \text{CTI}$
Material Group II	$400 \leq \text{CTI} < 600$
Material Group IIIa	$175 \leq \text{CTI} < 400$
Material Group IIIb	$100 \leq \text{CTI} < 175$

The material group is checked by evaluation of the test data for the material according to IEC 60112 using 50 drops of solution A.

If the material group is not known, Material Group IIIb shall be assumed.

If a CTI of 175 or greater is needed, and the data is not available, the material group can be established with a test for proof tracking index (PTI) as detailed in IEC 60112. A material may be included in a group if its PTI established by these tests is equal to, or greater than, the lower value of the CTI specified for the group.

5.4.3.4 Compliance criteria

Compliance is checked by measurement taking into account Annex O, Annex T and Annex V.

Table 18 – Minimum creepage distances for basic insulation and supplementary insulation in mm

RMS working voltage up to and including V	Pollution degree						
	1 ^a	2			3		
	Material group						
	I, II, IIIa, IIIb	I	II	IIIa, IIIb	I	II	IIIa, IIIb ^b
10	0,08	0,4	0,4	0,4	1,0	1,0	1,0
12,5	0,09	0,42	0,42	0,42	1,05	1,05	1,05
16	0,1	0,45	0,45	0,45	1,1	1,1	1,1
20	0,11	0,48	0,48	0,48	1,2	1,2	1,2
25	0,125	0,5	0,5	0,5	1,25	1,25	1,25
32	0,14	0,53	0,53	0,53	1,3	1,3	1,3
40	0,16	0,56	0,8	1,1	1,4	1,6	1,8
50	0,18	0,6	0,85	1,2	1,5	1,7	1,9
63	0,2	0,63	0,9	1,25	1,6	1,8	2,0
80	0,22	0,67	0,95	1,3	1,7	1,9	2,1
100	0,25	0,71	1,0	1,4	1,8	2,0	2,2
125	0,28	0,75	1,05	1,5	1,9	2,1	2,4
160	0,32	0,8	1,1	1,6	2,0	2,2	2,5
200	0,42	1,0	1,4	2,0	2,5	2,8	3,2
250	0,56	1,25	1,8	2,5	3,2	3,6	4,0
320	0,75	1,6	2,2	3,2	4,0	4,5	5,0
400	1,0	2,0	2,8	4,0	5,0	5,6	6,3
500	1,3	2,5	3,6	5,0	6,3	7,1	8,0
630	1,8	3,2	4,5	6,3	8,0	9,0	10
800	2,4	4,0	5,6	8,0	10	11	12,5
1 000	3,2	5,0	7,1	10	12,5	14	16
1 250	4,2	6,3	9,0	12,5	16	18	20
1 600	5,6	8,0	11	16	20	22	25
2 000	7,5	10	14	20	25	28	32
2 500	10	12,5	18	25	32	36	40
3 200	12,5	16	22	32	40	45	50
4 000	16	20	28	40	50	56	63
5 000	20	25	36	50	63	71	80
6 300	25	32	45	63	80	90	100
8 000	32	40	56	80	100	110	125
10 000	40	50	71	100	125	140	160
12 500	50	63	90	125			
16 000	63	80	110	160			
20 000	80	100	140	200			
25 000	100	125	180	250			
32 000	125	160	220	320			
40 000	160	200	280	400			
50 000	200	250	360	500			
63 000	250	320	450	600			
<p>Linear interpolation may be used between the nearest two points, the calculated minimum creepage distance being rounded to the next higher 0,1 mm increment or the value in the next row below whichever is lower.</p> <p>For reinforced insulation, the rounding to the next higher 0,1 mm increment or to double the value in the next row is done after doubling the calculated value for basic insulation.</p>							
<p>^a The values for pollution degree 1 may be used if a sample complies with the tests of 5.4.1.5.2.</p> <p>^b Material group IIIb is not recommended for applications in pollution degree 3 with an r.m.s. working voltage above 630 V.</p>							

Table 19 – Minimum values of creepage distances (in mm) for frequencies higher than 30 kHz and up to 400 kHz

Peak working voltage kV	30 kHz < f ≤ 100 kHz	100 kHz < f ≤ 200 kHz	200 kHz < f ≤ 400 kHz
0,1	0,0167	0,02	0,025
0,2	0,042	0,043	0,05
0,3	0,083	0,09	0,1
0,4	0,125	0,13	0,15
0,5	0,183	0,23	0,25
0,6	0,267	0,38	0,4
0,7	0,358	0,55	0,68
0,8	0,45	0,8	1,1
0,9	0,525	1,0	1,9
1	0,6	1,15	3

The values for the **creepage distances** in the table apply for **pollution degree 1**. For **pollution degree 2** a multiplication factor of 1,2 and for **pollution degree 3**, a multiplication factor 1,4 shall be used.

Linear interpolation may be applied.

The data given in this Table 19 (from Table 2 of IEC 60664-4:2005) does not take into account the influence of tracking phenomena. For that purpose Table 18 has to be taken into account. Therefore, if values in Table 19 are smaller than those in Table 18, the values of Table 18 apply.

5.4.4 Solid insulation

5.4.4.1 General requirements

The requirements of this subclause apply to solid insulation, including compounds and gel materials used as insulation.

Solid insulation shall not break down:

- due to overvoltages, including transients, that enter the equipment, and peak voltages that may be generated within the equipment; and
- due to pinholes in thin layers of insulation.

Solvent-based enamel coatings shall not be used for **basic insulation**, **supplementary insulation** or **reinforced insulation** except as given in G.6.2.

Except for printed boards, **solid insulation** shall either:

- comply with minimum distances through insulation in accordance with 5.4.4.2; or
- meet the requirements and pass the tests in 5.4.4.3 to 5.4.4.7, as applicable.

Glass used as **solid insulation** shall comply with the glass breakage test as specified in Clause T.9. Damage to the finish, small dents that do not reduce **clearances** below the specified values, surface cracks and the like are ignored. If a through crack appears, **clearances** and **creepage distances** shall not be reduced below the specified values.

For printed boards, see Clause G.13. For antenna terminals, see 5.4.5. For **solid insulation** on internal wiring, see 5.4.6.

5.4.4.2 Minimum distance through insulation

Except where another subclause of Clause 5 applies, distances through insulation shall be dimensioned according to the application of the insulation and as follows (see Figure O.15 and Figure O.16):

- if the **working voltage** does not exceed ES2 voltage limits, there is no requirement for distance through insulation;
- if the **working voltage** exceeds ES2 voltage limits, the following rules apply:
 - for **basic insulation**, no minimum distance through insulation is specified;
 - for **supplementary insulation** or **reinforced insulation** comprised of a single layer, the minimum distance through insulation shall be 0,4 mm;
 - for **supplementary insulation** or **reinforced insulation** comprised of multiple layers, the minimum distance through insulation shall comply with 5.4.4.6.

5.4.4.3 Insulating compound forming solid insulation

There is no minimum internal **clearance** or **creepage distance** required if:

- the insulating compound completely fills the casing of a component or subassembly, including a semiconductor device (for example, an optocoupler); and
- the component or subassembly meets the minimum distances through insulation of 5.4.4.2; and
- a single sample passes the tests of 5.4.1.5.2.

NOTE Some examples of such treatment are variously known as potting, encapsulation and vacuum impregnation.

Such constructions containing cemented joints shall also comply with 5.4.4.5.

Alternative requirements for semiconductor devices are given in 5.4.4.4.

For printed boards, see Clause G.13 and for wound components, see 5.4.4.7.

Compliance is checked by sectioning the sample. There shall be no visible voids in the insulating material.

5.4.4.4 Solid insulation in semiconductor devices

There is no minimum internal **clearance** or **creepage distance**, and no minimum distance through insulation for **supplementary insulation** or **reinforced insulation** consisting of an insulating compound completely filling the casing of a semiconductor component (for example, an optocoupler) provided that the component:

- passes the **type tests** and inspection criteria of 5.4.7; and passes **routine tests** for electric strength during manufacturing, using the appropriate test in 5.4.9.1; or
- complies with Clause G.12.

Such constructions containing cemented joints shall also comply with 5.4.4.5.

Alternatively, a semiconductor may be evaluated according to 5.4.4.3.

5.4.4.5 Insulating compound forming cemented joints

The requirements specified below apply when an insulating compound forms a cemented joint between two non-conductive parts or between another non-conductive part and itself. These requirements do not apply to optocouplers that comply with IEC 60747-5-5.

Where the path between conductive parts is filled with insulating compound, and the insulating compound forms a cemented joint between two non-conductive parts or between a non-conductive part and itself (see Figure O.14, Figure O.15 and Figure O.16), one of the following a), b) or c) applies.

- a) The distance along the path between the two conductive parts shall be not less than the minimum **clearances** and **creepage distances** for **pollution degree** 2. The requirements for distance through insulation of 5.4.4.2 do not apply along the joint.
- b) The distance along the path between the two conductive parts shall not be less than the minimum **clearances** and **creepage distances** for **pollution degree** 1. Additionally, one sample shall pass the test of 5.4.1.5.2. The requirements for distance through insulation in 5.4.4.2 do not apply along the joint.
- c) The requirements for distance through insulation of 5.4.4.2 apply between the conductive parts along the joint. Additionally, three samples shall pass the test of 5.4.7.

For a) and b) above, if the insulating materials involved have different material groups, the worst case is used. If a material group is not known, Material Group IIIb shall be used.

For b) and c) above, the tests of 5.4.1.5.2 and 5.4.7 are not applied to the inner layers of a printed board made using pre-preg if the temperature of the printed board measured during the heating test of 5.4.1.4 does not exceed 90 °C.

NOTE Some examples of cemented joints are as follows:

- two non-conductive parts cemented together (for example, two layers of a multilayer board, see Figure O.14) or the split bobbin of a transformer where the centre limb is secured by adhesive (see Figure O.16);
- spirally wrapped insulation on a winding wire, sealed by adhesive insulating compound, is an example of PD1; or
- the joint between a non-conductive part (the casing) and the insulating compound itself in an optocoupler (see Figure O.15).

5.4.4.6 Thin sheet material

5.4.4.6.1 General requirements

There is no dimensional or constructional requirement for insulation in thin sheet material used as **basic insulation**.

NOTE An instrument to carry out the electric strength test on thin sheets of insulating material is described in Figure 29.

Insulation in thin sheet materials may be used for **supplementary insulation** and **reinforced insulation**, irrespective of the distance through insulation, provided that:

- two or more layers are used; and
- the insulation is within the equipment **enclosure**; and
- the insulation is not subject to handling or abrasion during **ordinary person** or **instructed person** servicing; and
- the requirements and tests of 5.4.4.6.2 (for separable layers) or 5.4.4.6.3 (for non-separable layers) are met.

The two or more layers are not required to be fixed to the same conductive part. The two or more layers can be:

- fixed to one of the conductive parts requiring separation; or
- shared between the two conductive parts; or
- not fixed to either conductive part.

For insulation in three or more layers of non-separable thin sheet materials:

- minimum distances through insulation are not required; and
- each layer of insulation does not have to be of the same material.

5.4.4.6.2 Separable thin sheet material

In addition to the requirements of 5.4.4.6.1, for:

- **supplementary insulation** consisting of two layers of material, each layer shall pass the electric strength test for **supplementary insulation**; or
- **supplementary insulation** consisting of three layers of material, any combination of two layers shall pass the electric strength test for **supplementary insulation**; or
- **reinforced insulation** consisting of two layers of material, each layer shall pass the electric strength test for **reinforced insulation**; or
- **reinforced insulation** consisting of three layers of material, any combination of two layers shall pass the electric strength test for **reinforced insulation**.

If more than three layers are used, layers may be divided into two or three groups of layers. Each group of layers shall pass the electric strength test for the appropriate insulation.

A test on a layer or group of layers is not repeated on an identical layer or group.

There is no requirement for all layers of insulation to be of the same material and thickness.

5.4.4.6.3 Non-separable thin sheet material

For insulation consisting of non-separable thin sheet materials, in addition to the requirements of 5.4.4.6.1, the test procedures in Table 20 are applied. There is no requirement for all layers of insulation to be of the same material and thickness.

Compliance is checked by inspection and by the tests specified in Table 20.

Table 20 – Tests for insulation in non-separable layers

Number of layers	Test procedure
Supplementary insulation	
Two or more layers:	The test procedure of 5.4.4.6.4 is applied
Reinforced insulation	
Two layers:	The test procedure of 5.4.4.6.4 is applied
Three or more layers:	The test procedures of 5.4.4.6.4 and 5.4.4.6.5 ^a are applied
NOTE The purpose of the tests in 5.4.4.6.5 is to ensure that the material has adequate strength to resist damage when hidden in inner layers of insulation. Therefore, the tests are not applied to insulation in two layers. The tests in 5.4.4.6.5 are not applied to supplementary insulation .	
^a Where the insulation is integral to winding wire, the test does not apply.	

5.4.4.6.4 Standard test procedure for non-separable thin sheet material

For non-separable layers, electric strength tests are applied in accordance with 5.4.9.1 to all layers together. The test voltage is:

- 200 % of U_{test} if two layers are used; or
- 150 % of U_{test} if three or more layers are used,

*where U_{test} is the test voltage specified in 5.4.9.1 for **supplementary insulation** or **reinforced insulation** as appropriate.*

NOTE Unless all the layers are of the same material and have the same thickness, there is a possibility that the test voltage will be divided unequally between layers, causing breakdown of a layer that would have passed if tested separately.

5.4.4.6.5 Mandrel test

The test requirements for **reinforced insulation** made of three or more thin insulating sheets of material that are inseparable are specified below.

NOTE This test is based on IEC 61558-1 and will give the same results.

Three test samples, each individual sample consisting of three or more layers of non-separable thin sheet material forming **reinforced insulation**, are used. One sample is fixed to the mandrel of the test fixture given in Figure 25. The fixing shall be performed as shown in Figure 26.

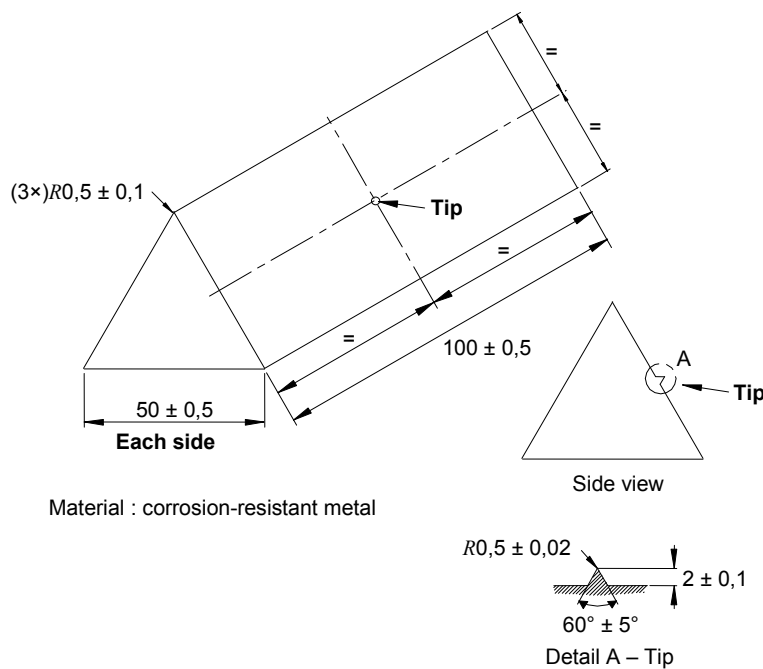

IEC 0348/14

Dimensions in millimetres

Figure 25 – Mandrel

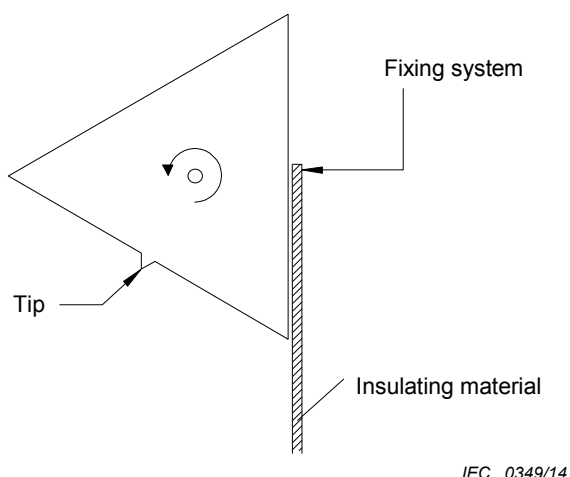

IEC 0349/14

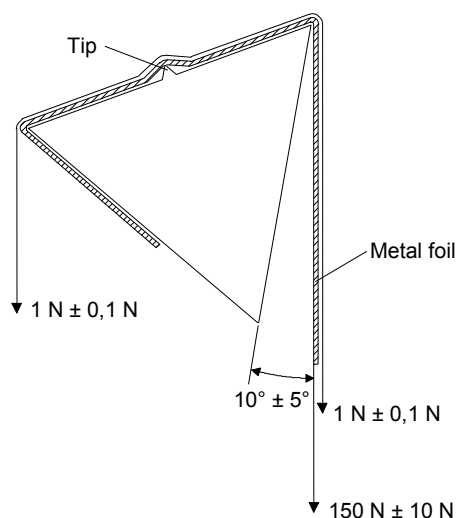

IEC 0350/14

The final position of the mandrel is rotated $230^\circ \pm 5^\circ$ from the initial position.

Dimensions in millimetres

Figure 26 – Initial position of mandrel

Figure 27 – Final position of mandrel

A pull is applied to the free end of the sample, using an appropriate clamping device. The mandrel is rotated:

- from the initial position (Figure 26) to the final position (Figure 27) and back;
- a second time from the initial position to the final position.

If a sample breaks during rotation where it is fixed to the mandrel or to the clamping device, this does not constitute a failure. If a sample breaks at any other place, the test has failed.

After the above test, a sheet of metal foil, $0,035 \text{ mm} \pm 0,005 \text{ mm}$ thick, at least 200 mm long, is placed along the surface of the sample, hanging down on each side of the mandrel (see Figure 27). The surface of the foil in contact with the sample shall be conductive, not oxidized or otherwise insulated. The foil is positioned so that its edges are not less than 20 mm from the edges of the sample (see Figure 28). The foil is then tightened by two equal weights, one at each end, using appropriate clamping devices.

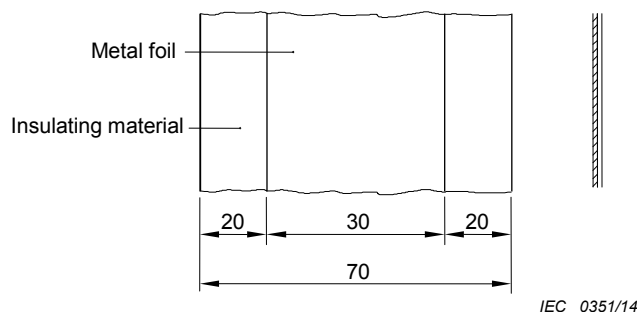

IEC 0351/14

Dimensions in millimetres

Figure 28 – Position of metal foil on insulating material

While the mandrel is in its final position, and within the 60 s following the final positioning, an electric strength test is applied between the mandrel and the metal foil in accordance with 5.4.9.1. The test voltage is 150 % of U_{test} , but not less than 5 kV r.m.s. U_{test} is the test voltage specified in 5.4.9.1 for **reinforced insulation** as appropriate.

The test is repeated on the other two samples.

5.4.4.7 Solid insulation in wound components

Basic insulation, supplementary insulation or **reinforced insulation** in a wound component may be provided by:

- the insulation on wound components (see Clause G.5); or
- the insulation on other wire (see Clause G.6); or
- a combination of the two.

Wound components containing cemented joints shall also comply with 5.4.4.5.

Planar transformers shall comply with the requirements of Clause G.13.

5.4.4.8 Compliance criteria

*Compliance with the requirements of 5.4.4.2 to 5.4.4.7 for the adequacy of **solid insulation** is checked by inspection and measurement, taking into account Annex O, by the electric strength tests of 5.4.9.1 and the additional tests required in 5.4.4.2 to 5.4.4.7, as applicable.*

5.4.4.9 Solid insulation requirements at frequencies higher than 30 kHz

The suitability of the **solid insulation** shall be determined as follows:

- Determine the value of the breakdown electric field strength of the insulation material at **mains** power frequency E_P in kV/mm for the insulating material. See Table 21 for examples of commonly used materials at **mains** power frequency.
- Determine the reduction factor K_R for the breakdown electric field strength of the insulating material at the applicable frequency from Table 22 or Table 23. If the material is not one listed in Table 22 or Table 23, use the average reduction factor in the last row of Table 22 or Table 23 as applicable.
- Determine the value of the breakdown electric field strength at the applicable frequency E_F by multiplying the value E_P with the reduction factor K_R .

$$E_F = E_P \times K_R$$

- Determine the actual electric strength V_W of the insulating material by multiplying the value E_F with the total thickness (d in mm) of the insulating material.

$$V_W = E_F \times d$$

- For **basic insulation** or **supplementary insulation**, V_W shall exceed the measured high frequency **peak working voltage** V_{PW} by 20 %.

$$V_W > 1,2 \times V_{PW}$$

- For **reinforced insulation**, V_W shall exceed twice the measured high frequency **peak working voltage** V_{PW} by 20 %.

$$V_W > 1,2 \times 2 \times V_{PW}$$

As an alternative to the above,

- the electric strength test of 5.4.9.1 may be applied under the following conditions:
 - the field strength is approximately uniform; and
 - no voids or air gaps are present in the **solid insulation**; or

- the insulation may be subjected to the high-frequency breakdown test according to 7.4 of IEC 60664-4:2005 with the test potential at the frequency of the actual measured **working voltage**.

NOTE In this context, the electric field is considered to be approximately uniform if the deviations are less than 20 % from the average value of the field strength.

Table 21 – Electric field strength E_P for some commonly used materials

Material	Breakdown electric field strength E_P				
	kV/mm				
	Thickness of the material mm				
	0,75	0,08	0,06	0,05	0,03
Porcelain ^a	9,2	-	-	-	-
Silicon-glass ^a	14	-	-	-	-
Phenolic ^a	17	-	-	-	-
Ceramic ^a	19	-	-	-	-
Teflon® ^{a 3}	27	-	-	-	-
Melamine-glass ^a	27	-	-	-	-
Mica ^a	29	-	-	-	-
Paper phenolic ^a	38	-	-	-	-
Polyethylene ^b	49	-	-	52	-
Polystyrene ^c	55	65	-	-	-
Glass ^a	60	-	-	-	-
Kapton® ^{a 4}	303	-	-	-	-
FR530L ^a	33	-	-	-	-
Mica-filled phenolic ^a	28	-	-	-	-
Glass-silicone laminate ^a	18	-	-	-	-
Cellulose-acetobutyrate ^d	-	-	120	-	210
Polycarbonate ^d	-	-	160	-	270
Cellulose-triacetate ^d	-	-	120	-	210

NOTE Missing values in the above and the values for other materials not in the list are under investigation.

^a For the breakdown electric field strength of the specified materials, the E_P value of 0,75 mm thickness may be used for all thicknesses.

^b The E_P value of 0,05 mm thickness is used for the insulation equal to or thinner than 0,05 mm. The E_P value of 0,75 mm thickness is used otherwise.

^c The E_P value of 0,08 mm thickness is used for the insulation equal to or thinner than 0,08 mm. The E_P value of 0,75 mm thickness is used otherwise.

^d The E_P value of 0,03 mm thickness is used for the insulation equal to or thinner than 0,03 mm. The E_P value of 0,06 mm thickness is used for the insulation equal to or thinner than 0,06 mm and greater than 0,03 mm.

³ Teflon® is the trademark of a product supplied by DuPont. This information is given for the convenience of users of this document and does not constitute an endorsement by IEC of the product named. Equivalent products may be used if they can be shown to lead to the same results.

⁴ Kapton® is the trademark of a product supplied by DuPont. This information is given for the convenience of users of this document and does not constitute an endorsement by IEC of the product named. Equivalent products may be used if they can be shown to lead to the same results.

Table 22 – Reduction factors for the value of breakdown electric field strength E_p at higher frequencies

Material ^a	Frequency kHz										
	30	100	200	300	400	500	1 000	2 000	3 000	5 000	10 000
	Reduction factor K_R										
Porcelain	0,52	0,42	0,40	0,39	0,38	0,37	0,36	0,35	0,35	0,34	0,30
Silicon-glass	0,79	0,65	0,57	0,53	0,49	0,46	0,39	0,33	0,31	0,29	0,26
Phenolic	0,82	0,71	0,53	0,42	0,36	0,34	0,24	0,16	0,14	0,13	0,12
Ceramic	0,78	0,64	0,62	0,56	0,54	0,51	0,46	0,42	0,37	0,35	0,29
Teflon®	0,57	0,54	0,52	0,51	0,48	0,46	0,45	0,44	0,41	0,37	0,22
Melamine-glass	0,48	0,41	0,31	0,27	0,24	0,22	0,16	0,12	0,10	0,09	0,06
Mica	0,69	0,55	0,48	0,45	0,41	0,38	0,34	0,28	0,26	0,24	0,20
Paper phenolic	0,58	0,47	0,40	0,32	0,26	0,23	0,16	0,11	0,08	0,06	0,05
Polyethylene	0,36	0,28	0,22	0,21	0,20	0,19	0,16	0,13	0,12	0,12	0,11
Polystyrene	0,35	0,22	0,15	0,13	0,13	0,11	0,08	0,06	0,06	0,06	0,06
Glass	0,37	0,21	0,15	0,13	0,11	0,10	0,08	0,06	0,05	0,05	0,04
Other materials	0,43	0,35	0,30	0,27	0,25	0,24	0,20	0,17	0,16	0,14	0,12

If the frequency lies between the values in any two columns, the reduction factor value in the next column shall be used or a logarithmic interpolation may be used between any two adjacent columns with the calculated value rounded down to the nearest 0,01 value.

^a This data is for materials that are 0,75 mm thick.

Table 23 – Reduction factors for the value of breakdown electric field strength E_p at higher frequencies for thin materials

Thin material	Frequency kHz										
	30	100	200	300	400	500	1 000	2 000	3 000	5 000	10 000
	Reduction factor K_R										
Cellulose-acetobutyrate (0,03 mm)	0,67	0,43	0,32	0,27	0,24	0,20	0,15	0,11	0,09	0,07	0,06
Cellulose-acetobutyrate (0,06 mm)	0,69	0,49	0,36	0,30	0,26	0,23	0,17	0,13	0,11	0,08	0,06
Polycarbonate (0,03 mm)	0,61	0,39	0,31	0,25	0,23	0,20	0,14	0,10	0,08	0,06	0,05
Polycarbonate (0,06 mm)	0,70	0,49	0,39	0,33	0,28	0,25	0,19	0,13	0,11	0,08	0,06
Cellulose-triacetate (0,03 mm)	0,67	0,43	0,31	0,26	0,23	0,20	0,14	0,10	0,09	0,07	0,06
Cellulose-triacetate (0,06 mm)	0,72	0,50	0,36	0,31	0,27	0,23	0,17	0,13	0,10	0,10	0,06
Other thin foil materials	0,68	0,46	0,34	0,29	0,25	0,22	0,16	0,12	0,10	0,08	0,06

If the frequency lies between the values in any two columns, the reduction factor value in the next column shall be used or a logarithmic interpolation may be used between any two adjacent columns with the calculated value rounded down to the nearest 0,01 value

5.4.5 Antenna terminal insulation

5.4.5.1 General

The insulation

- between antenna terminals and the **mains**, and
- between antenna terminals and ES1 circuits or ES2 circuits
 - isolated from the antenna circuits, and
 - having terminals for connection to **external circuits**.

shall withstand electrostatic discharges at the antenna terminals.

This test does not apply to equipment where one antenna terminal on the equipment is connected to earth in accordance with 5.6.7.

NOTE In China, connection of the CATV to the main protective earthing terminal of equipment is not permitted.

If a **mains**-connected equipment provides non-**mains** supply voltages to other equipment having antenna terminals, the test shall apply between **mains** terminals and the non-**mains** supply voltage terminals.

5.4.5.2 Test method

*The insulation shall be conditioned as described in G.10.3.1 and tested as described in G.10.3.2. The equipment shall be placed on an insulating surface. The impulse test generator output shall be connected to the antenna terminals connected together and to the **mains** terminals connected together. The equipment is not energized during this test.*

*If the equipment has ES1 circuits or ES2 circuits that are isolated from the antenna circuits and that have terminals for connection to **external circuits**, the test is repeated with the generator connected to the antenna terminals connected together and the **external circuit** terminals connected together.*

NOTE Test personnel are cautioned not to touch the equipment during this test.

5.4.5.3 Compliance criteria

Compliance is checked by measuring the insulation resistance with 500 V d.c.

The equipment complies with the requirement if the insulation resistance measured after 1 min is not less than the values given in Table 24.

Table 24 – Values for insulation resistance

Insulation requirements between parts	Insulation resistance MΩ
Between parts separated by basic insulation or by supplementary insulation	2
Between parts separated by double insulation or reinforced insulation	4

*As an alternative to the above, compliance may be checked by an electric strength test in accordance with 5.4.9.1 for **basic insulation** or **reinforced insulation** as applicable. The test voltage shall be the highest of the test voltages determined by methods 1, 2 and 3. There shall be no insulation breakdown.*

5.4.6 Insulation of internal wire as a part of a supplementary safeguard

The requirements of this subclause apply where the insulation of an internal wire, alone, meets the requirements for **basic insulation**, but does not meet the requirements for **supplementary insulation**.

Where wire insulation is used as part of a **supplementary insulation** system and the wire insulation is **accessible** to an **ordinary person**:

- the wire insulation does not need to be handled by the **ordinary person**; and
- the wire is placed such that the **ordinary person** is unlikely to pull on it, or the wire shall be so fixed that the connecting points are relieved from strain; and
- the wire is routed and fixed such as not to touch unearthed **accessible** conductive parts; and
- the wire insulation passes the electric strength test of 5.4.9.1 for **supplementary insulation**; and
- the distance through the wire insulation shall be at least as given in Table 25.

Table 25 – Distance through insulation of internal wiring

Working voltage in case of failure of basic insulation		Minimum distance through insulation
V peak or d.c.	V r.m.s. (sinusoidal)	mm
> 71 ≤ 350	> 50 ≤ 250	0,17
> 350	> 250	0,31

Compliance is checked by inspection and measurement, and by the test of 5.4.9.1.

5.4.7 Tests for semiconductor components and for cemented joints

Three samples are subjected to the thermal cycling sequence of 5.4.1.5.3. Before testing a cemented joint, any winding of solvent-based enamelled wire used in the component is replaced by metal foil or by a few turns of bare wire, placed close to the cemented joint.

The three samples are then tested as follows:

- *one of the samples is subjected to the electric strength test of 5.4.9.1, immediately after the last period at $(T_1 \pm 2)$ °C during thermal cycling, except that the test voltage is multiplied by 1,6; and*
- *the other samples are subjected to the relevant electric strength test of 5.4.9.1 after the humidity conditioning of 5.4.8, except that the test voltage is multiplied by 1,6.*

Compliance is checked by test and the following inspections:

Except for cemented joints on the same inner surface of a printed board, compliance is checked by inspection of the cross-sectional area, and there shall be no visible voids, gaps or cracks in the insulating material.

In the case of insulation between conductors on the same inner surface of printed boards and the insulation between conductors on different surfaces of multilayer boards, compliance is checked by external visual inspection. There shall be no delamination.

5.4.8 Humidity conditioning

Humidity conditioning is carried out for 48 h in a cabinet or room containing air with a relative humidity of (93 ± 3) %. The temperature of the air, at all places where samples can be located, is maintained within ± 2 °C of any value t between 20 °C and 30 °C so that

condensation does not occur. During this conditioning, the component or subassembly is not energized.

For tropical conditions the time duration shall be 120 h at a temperature of (40 ± 2) °C and a relative humidity of (93 ± 3) %.

Before the humidity conditioning, the sample is brought to a temperature between the specified temperature t and $(t + 4)$ °C.

5.4.9 Electric strength test

5.4.9.1 Test procedure for type testing of solid insulation

Unless otherwise specified, compliance is checked either

- immediately following the temperature test in 5.4.1.4, or
- if a component or subassembly is tested separately outside the equipment, it is brought to the temperature attained by that part during the temperature test in 5.4.1.4 (for example, by placing it in an oven) prior to performing the electric strength test.

Alternatively, thin sheet material for **supplementary insulation** or **reinforced insulation** may be tested at room temperature.

Unless otherwise specified elsewhere in this standard, the test voltage for the electric strength of **basic insulation**, **supplementary insulation** or **reinforced insulation** is the highest value of the following three methods:

- Method 1: Determine the test voltage according to Table 26 using the **required withstand voltage** (based on transient voltages from the a.c. **mains** or d.c. **mains** or from **external circuits**).
- Method 2: Determine the test voltage according to Table 27 using the **peak working voltage**.
- Method 3: Determine the test voltage according to Table 28 using the nominal **mains** voltage (to cover **temporary overvoltages**).

The insulation is subjected to the highest test voltage as follows:

- by applying an a.c. voltage of substantially sine-wave form having a frequency of 50 Hz or 60 Hz; or
- by applying a **d.c. voltage** in one polarity for the time specified below and then repeat it in reverse polarity.

The voltage applied to the insulation under test is gradually raised from zero to the prescribed voltage and maintained at that value for 60 s (for **routine tests** see 5.4.9.2).

Insulation coatings are tested with metal foil in contact with the insulating surface. This procedure is limited to places where the insulation is likely to be weak (for example, where there are sharp metal edges under the insulation). If practicable, insulating linings are tested separately. Care is taken that the metal foil is so placed that no flashover occurs at the edges of the insulation. Where adhesive metal foil is used, the adhesive shall be conductive.

To avoid damage to components or insulations that are not involved in the test, ICs or the like, may be disconnected and equipotential bonding may be used. A varistor complying with Clause G.8 may be removed during the test.

For equipment incorporating **basic insulation** and **supplementary insulation** in parallel with **reinforced insulation**, care is taken that the voltage applied to the **reinforced insulation** does not overstress **basic insulation** or **supplementary insulation**.

Where capacitors are in parallel with the insulation under test (for example, radio-frequency filter capacitors), d.c. test voltages shall be used.

Components providing a d.c. path in parallel with the insulation to be tested, such as discharge resistors for filter capacitors and voltage limiting devices, may be disconnected.

Where insulation of a transformer winding varies along the length of the winding in accordance with 5.4.1.6, an electric strength test method is used that stresses the insulation accordingly.

EXAMPLE Such a test method may be an induced voltage test that is applied at a frequency sufficiently high to avoid saturation of the transformer. The input voltage is raised to a value that would induce an output voltage equal to the required test voltage.

Table 26 – Test voltages for electric strength tests based on transient voltages

Required withstand voltage up to and including kV peak	Test voltage for basic insulation or supplementary insulation	Test voltage for reinforced insulation
	kV peak or d.c.	
0,33	0,33	0,5
0,5	0,5	0,8
0,8	0,8	1,5
1,5	1,5	2,5
2,5	2,5	4
4	4	6
6	6	8
8	8	12
12	12	18
U_R^a	U_R^a	$1,5 \times U_R^a$
Linear interpolation may be used between the nearest two points.		
^a U_R is any required withstand voltage higher than 12 kV.		

Table 27 – Test voltages for electric strength tests based on peak working voltages

Peak working voltage up to and including kV peak	Test voltage for basic insulation or supplementary insulation	Test voltage for reinforced insulation
	kV peak or d.c.	
0,33	0,43	0,53
0,5	0,65	0,8
0,8	1,04	1,28
1,5	1,95	2,4
2,5	3,25	4
4	5,2	6,4
6	7,8	9,6
8	10,4	12,8
12	15,6	19,2
U_P^a	$1,3 \times U_P^a$	$1,6 \times U_P^a$
Linear interpolation may be used between the nearest two points.		
^a U_P is any peak working voltage higher than 12 kV.		

Table 28 – Test voltages for electric strength tests based on temporary overvoltages

Nominal mains system voltage	Test voltage for basic insulation or supplementary insulation	Test voltage for reinforced insulation
V r.m.s.	kV peak or d.c.	
Up to and including 250	2	4
Over 250 up to and including 600	2,5	5

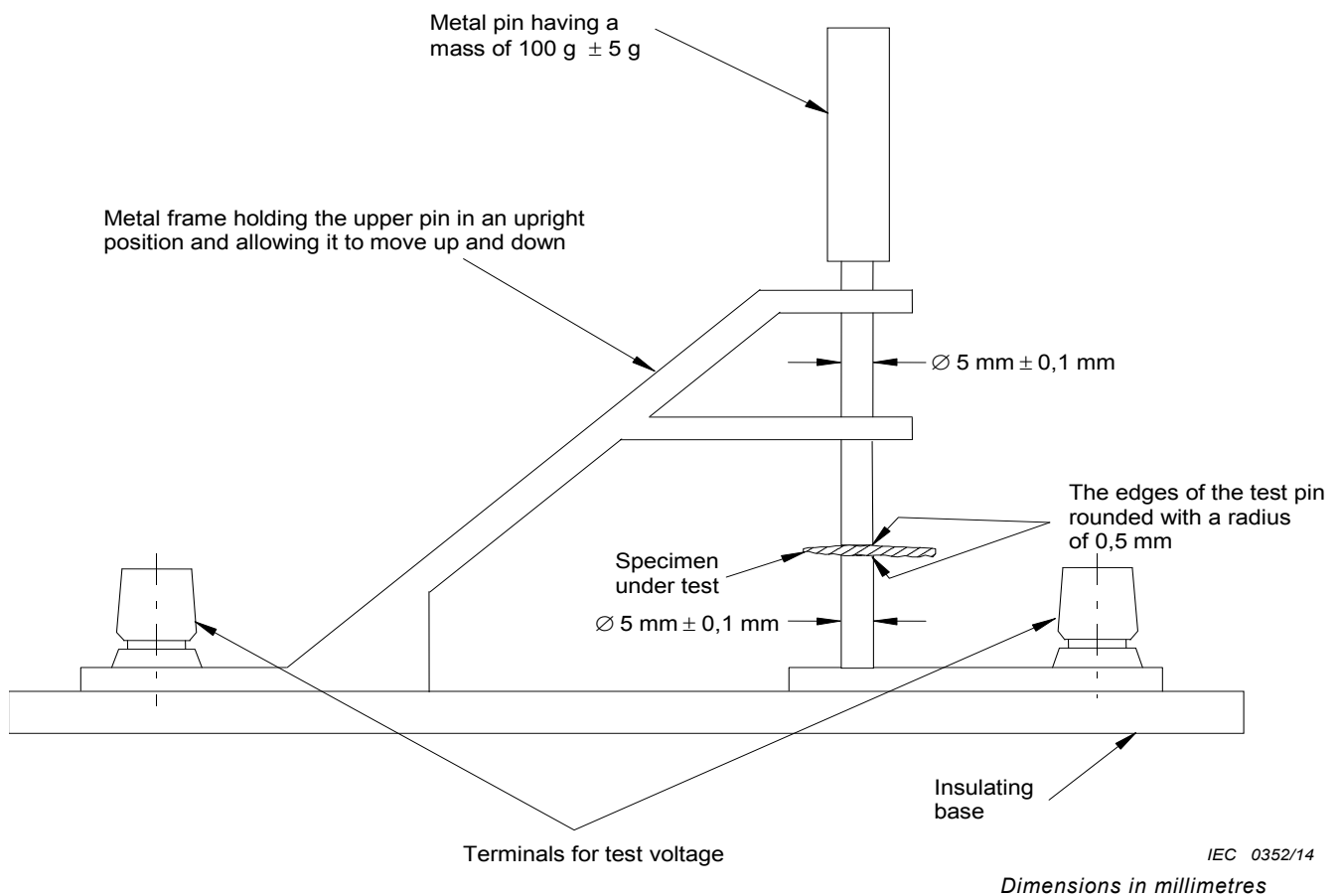

Figure 29 – Example of electric strength test instrument for solid insulation

NOTE Thin sheet insulation can be tested using the instrument of Figure 29.

There shall be no insulation breakdown during the test. Insulation breakdown is considered to have occurred when the current that flows as a result of the application of the test voltage, rapidly increases in an uncontrolled manner, that is, the insulation does not restrict the flow of the current. Corona discharge or a single momentary flashover is not regarded as insulation breakdown.

5.4.9.2 Test procedure for routine tests

Routine tests are performed according to 5.4.9.1, except for the following:

- the test may be performed at room temperature; and
- the duration of the electric strength test shall be between 1 s to 4 s; and
- the test voltage may be reduced by 10 %.

NOTE The above test conditions are also applicable to **routine tests** in production of the equipment or subassemblies.

There shall be no insulation breakdown during the test. Insulation breakdown is considered to have occurred when the current that flows as a result of the application of the test voltage, rapidly increases in an uncontrolled manner, that is, the insulation does not restrict the flow of the current. Corona discharge or a single momentary flashover is not regarded as insulation breakdown.

5.4.10 Safeguards against transient voltages from external circuits

5.4.10.1 Requirements

Adequate electrical separation shall be provided between **external circuits** of equipment as indicated in Table 14, ID number 1, Figure 30 and:

- non-conductive parts and unearthed conductive parts of the equipment expected to be held or otherwise maintained in continuous contact with the body during normal use (for example, a telephone handset or head set or the palm rest surface of a laptop or notebook computer);
- accessible** parts and circuitry, except for the pins of connectors. However, such pins shall not be **accessible** under **normal operating conditions** by the blunt probe of Figure V.3;
- another ES1 or ES2 part separated from the **external circuit**. The requirement for separation applies whether or not the ES1 or ES2 part is **accessible**.

These requirements do not apply where circuit analysis and equipment investigation indicate that adequate protection is assured by other means (for example, between two circuits each of which has a permanent connection to protective earth).

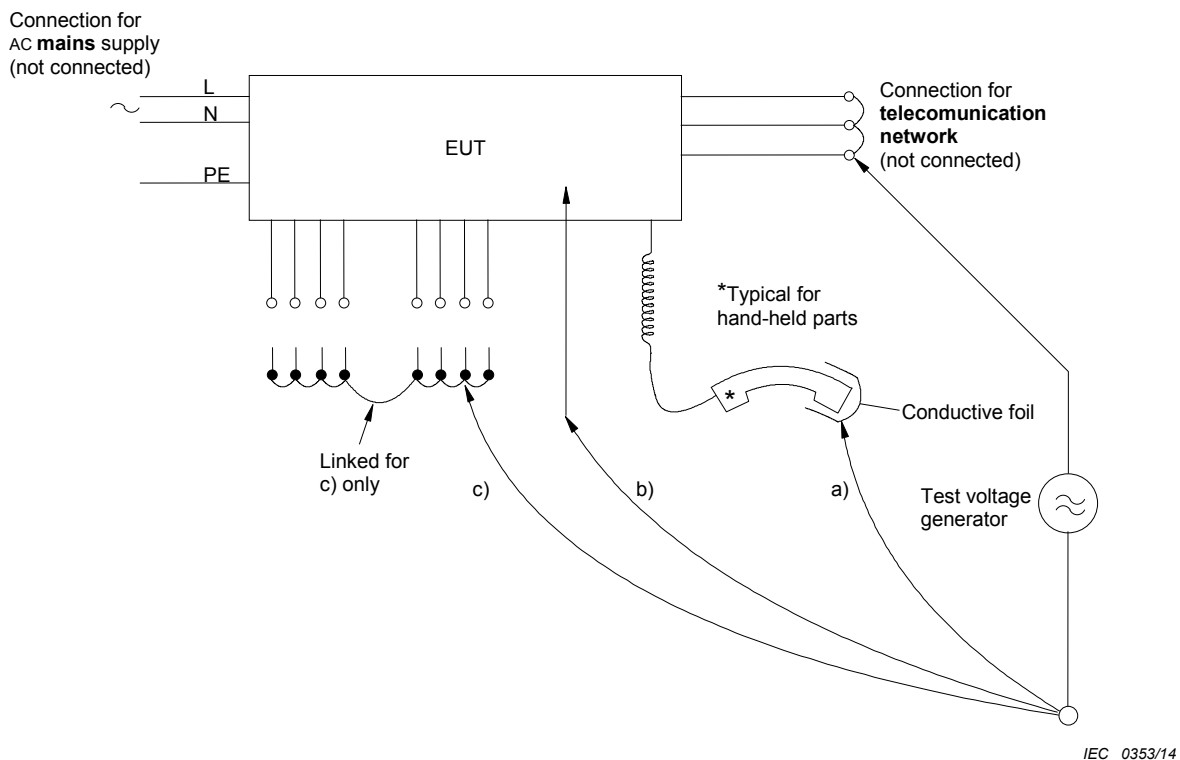

Figure 30 – Application points of test voltage

5.4.10.2 Test methods

5.4.10.2.1 General

The separation is checked by the test of either 5.4.10.2.2 or 5.4.10.2.3.

During the test:

- all conductors intended to be connected to the **external circuit** are connected together, including any conductors that may be connected to earth in the **external circuit**; and
- all conductors intended to be connected to other **external circuits** are also connected together.

Table 29 – Test values for electric strength tests

Parts	Impulse test	Steady state test
Parts indicated in 5.4.10.1 a) ^a	2,5 kV 10/700 μs	1,5 kV
Parts indicated in 5.4.10.1 b) and c) ^b	1,5 kV 10/700 μs ^c	1,0 kV
^a Surge suppressors shall not be removed. ^b Surge suppressors may be removed, provided that such devices pass the impulse test of 5.4.10.2.2 when tested as components outside the equipment. ^c During this test, it is allowed for a surge suppressor to operate and for a sparkover to occur in a GDT.		

5.4.10.2.2 Impulse test

The electrical separation is subjected to ten impulses of alternating polarity. The interval between successive impulses is 60 s with a voltage as given in Table 29.

5.4.10.2.3 Steady-state test

The electrical separation is subjected to an electric strength test according to 5.4.9.1, with a voltage as given in Table 29.

5.4.10.3 Compliance criteria

During the tests of 5.4.10.2.2 and 5.4.10.2.3:

- there shall be no insulation breakdown; and
- except as indicated in Table 29, footnote ^b, a surge suppressor shall not operate, or a sparkover shall not occur within a GDT.

For the electric strength test, insulation breakdown is considered to have occurred when the current that flows as a result of the application of the test voltage rapidly increases in an uncontrolled manner.

For the impulse tests, insulation breakdown is verified in one of the following two ways:

- during the application of the impulses, by observation of oscillograms, surge suppressor operation or breakdown through insulation is judged from the shape of an oscillogram.
- after application of all the impulses, by an insulation resistance test. Disconnection of surge suppressors is permitted while insulation resistance is being measured. The test voltage is 500 V d.c. or, if surge suppressors are left in place, a d.c. test voltage that is 10 % less than the surge suppressor operating or striking voltage. The insulation resistance shall not be less than 2 MΩ.

5.4.11 Separation between external circuits and earth

5.4.11.1 General

These requirements apply only to equipment intended to be connected to **external circuits** indicated in Table 14, ID numbers 1 and 2.

These requirements do not apply to:

- **permanently connected equipment**; or
- **pluggable equipment type B**; or
- **stationary pluggable equipment type A**, that is intended to be used in a location having equipotential bonding (such as a telecommunication centre, a dedicated computer room or a **restricted access area**) and has installation instructions that require verification of the **protective earthing connection** of the socket-outlet by a **skilled person**; or
- **stationary pluggable equipment type A**, that has provision for a permanently connected **protective earthing conductor**, including instructions for the installation of that conductor to building earth by a **skilled person**.

5.4.11.2 Requirements

There shall be separation between circuitry intended to be connected to **external circuits** mentioned above and any parts or circuitry that will be earthed in some applications, either within the EUT or via other equipment.

SPDs that bridge the separation between ES1 or ES2 **external circuits** and earth shall have a minimum rated operating voltage U_{op} (for example, the sparkover voltage of a gas discharge tube) of:

$$U_{op} = U_{peak} + \Delta U_{sp} + \Delta U_{sa}$$

where

U_{peak} is one of the following values:

- for equipment intended to be installed in an area where the nominal voltage of the a.c. mains exceeds 130 V: 360 V;
- for all other equipment: 180 V.

ΔU_{sp} is the maximum increase of the rated operating voltage due to variations in SPD production. If this is not specified by the SPD manufacturer, ΔU_{sp} shall be taken as 10 % of the rated operating voltage of the SPD.

ΔU_{sa} is the maximum increase of the rated operating voltage due to the SPD ageing over the expected life of the equipment. If this is not specified by the SPD manufacturer, ΔU_{sa} shall be taken as 10 % of the rated operating voltage of the SPD.

$(\Delta U_{sp} + \Delta U_{sa})$ may be a single value provided by the component manufacturer.

5.4.11.3 Test method and compliance criteria

Compliance is checked by inspection and by the electric strength test of 5.4.9.1.

Components, other than capacitors, that bridge the separation, may be removed during electric strength testing. Components that are left in place during the test shall not be damaged.

If components are removed, the following additional test with a test circuit according to Figure 31 is performed with all components in place.

For equipment powered from **a.c. mains**, the test is performed with a voltage equal to the **rated voltage** of the equipment or to the upper voltage of the **rated voltage range**. For equipment powered from **d.c. mains**, the test is performed with a voltage equal to the highest nominal voltage of the **a.c. mains** in the region where the equipment is to be used (for example, 230 V for Europe or 120 V for North America).

The current flowing in the test circuit of Figure 31 shall not exceed 10 mA.

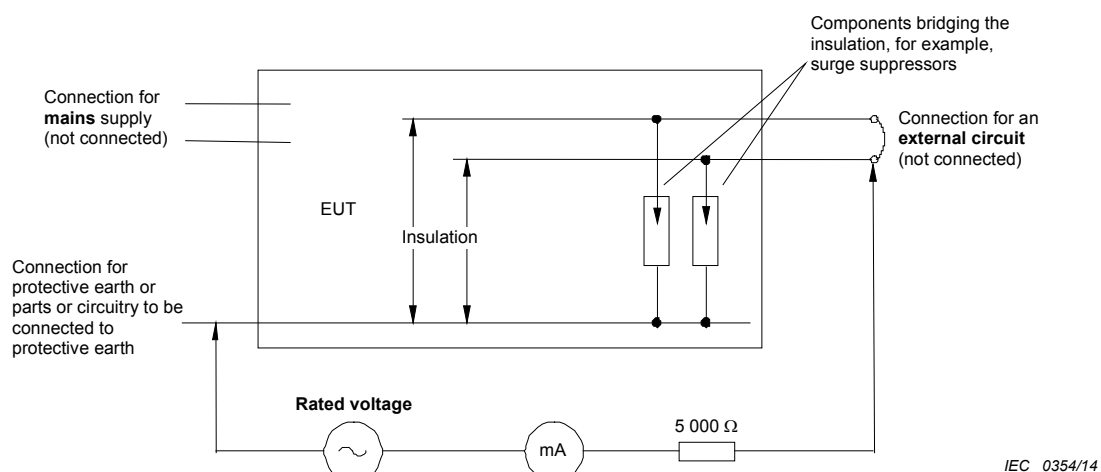

Figure 31 – Test for separation between an external circuit and earth

5.5 Components as safeguards

5.5.1 General

A component used as a **safeguard** shall:

- comply with all the applicable requirements for that **safeguard**; and
- be used within its rating.

NOTE See Annex G for the qualification of components used as a **safeguard**.

5.5.2 Capacitors and RC units

5.5.2.1 General requirements

Capacitors and RC units that serve as (electrical) **safeguards** shall comply with IEC 60384-14. RC units may consist of discrete components.

Capacitors or RC units with one or multiple capacitors shall:

- comply with Clause G.11, however, the requirements of Clause G.11 do not apply to the capacitor and RC unit used as a **basic safeguard** between:
 - ES3 isolated from the **mains** and protective earth; and
 - ES2 and protective earth; and
 - ES2 and ES1;
 and
- pass the electric strength test of 5.4.9.1, taking into account the total **working voltage** across the capacitor(s) and RC unit. Capacitors complying with IEC 60384-14 do not need to be tested if:

- the required peak impulse test voltage of Table G.8; and
 - the required r.m.s. test voltage of Table G.8 multiplied by 1,414,
- are equal to or greater than the required test voltage of 5.4.9.1.

When multiple capacitors are used, the test voltages of Table G.8 are multiplied by the number of capacitors used.

Under **single fault conditions**, if a capacitor or RC unit consists of more than one capacitor, the voltage on each of the remaining individual capacitors shall not exceed the voltage rating of the relevant individual capacitors.

NOTE In Norway, due to the IT power system used, capacitors are required to be rated for the applicable line-to-line voltage (230 V).

Class X capacitors may be used as **basic safeguards** in circuits isolated from the **mains** but shall not be used as a:

- **basic safeguard** in circuits connected to the **mains**; or
- **supplementary safeguard**.

Class X capacitors shall not be used as a **reinforced safeguard**.

5.5.2.2 Safeguards against capacitor discharge after disconnection of a connector

Where a capacitor voltage becomes **accessible** upon disconnection of a connector (for example, the **mains** connector) the **accessible** voltage measured 2 s after disconnection of the connector, shall comply with:

- the ES1 limits of Table 5 under **normal operating conditions** for an **ordinary person**; and
- the ES2 limits of Table 5 under **normal operating conditions** for an **instructed person**; and
- the ES2 limits of Table 5 under **single fault conditions** for both an **ordinary person** and an **instructed person**.

If an IC including capacitor discharge function (ICX) is used to comply with the above then under a **single fault condition** of an ICX or of any one component in the associated capacitor discharge circuit:

- the **accessible** voltage (for example, at the **mains** connector) shall not exceed the limits given above; or
- the ICX with the associated circuitry as provided in the equipment shall comply with the requirements of Clause G.16. Any impulse attenuating components (such as varistors and GDTs) are disconnected; or
- three samples of the ICX tested separately shall comply with the requirements of Clause G.16.

The measurement is made with an instrument having an input impedance consisting of a resistance of $100\text{ M}\Omega \pm 5\text{ M}\Omega$ in parallel with an input capacitance of 25 pF or less.

If a switch (for example, the **mains** switch) has an influence on the test result, it is placed in the most unfavorable position. The disconnection of the connector (start of discharge time) has to be done at the moment when the input capacity of the device under test is charged to its peak value.

Other methods that give a similar result as the above method may be used.

5.5.3 Transformers

Transformers used as a **safeguard** shall comply with G.5.3.

5.5.4 Optocouplers

Insulation of optocouplers used as a **safeguard** shall comply with the requirements of 5.4 or with Clause G.12.

5.5.5 Relays

Insulation of relays used as a **safeguard** shall comply with the requirements of 5.4.

5.5.6 Resistors

The requirements below apply to resistors:

- used as a **safeguard**; or
- that bridge **basic insulation, supplementary insulation** or **reinforced insulation**.

A single resistor or a group of resistors shall comply with **clearance** and **creepage distance** requirements of 5.4.2 and 5.4.3 respectively between its terminations for the total **working voltage** across the insulation (see Figure O.4).

A single resistor used as a **reinforced safeguard** or bridging a **reinforced insulation** shall comply with G.10.1 and the test of G.10.2.

NOTE In Finland, Norway and Sweden, resistors used as a **basic safeguard** or for bridging **basic insulation** in **class I pluggable equipment type A** shall comply with G.10.1 and the test of G.10.2.

For a group of resistors used as a **reinforced safeguard** or for bridging **reinforced insulation** the **clearance** and **creepage distance** are assessed as if each resistor were short-circuited in turn unless the group complies with G.10.1 and the test of G.10.2.

5.5.7 SPDs

5.5.7.1 Use of an SPD connected to reliable earthing

Where a varistor is used between the **mains** and earth:

- the earth connection shall comply with 5.6.7; and
- the varistor shall comply with Clause G.8.

5.5.7.2 Use of an SPD between mains and protective earth

Where an SPD is used between the **mains** and protective earth, it shall consist of a varistor and a GDT connected in series, where the following applies:

- the varistor shall comply with Clause G.8;
- the GDT shall comply with:
 - the electric strength test of 5.4.9.1 for **basic insulation**; and
 - the external **clearance** and **creepage distance** requirements of 5.4.2 and 5.4.3 respectively for **basic insulation**.

NOTE 1 Some examples of SPDs are MOVs, varistors and GDTs. A varistor is sometimes referred to as a VDR or a metal oxide varistor (MOV).

The above requirements do not apply to SPDs:

- intended for attenuating transient voltages from **external circuits**; and

- connected to reliable earth (see 5.5.7.1).

NOTE 2 It is not a requirement of this standard that surge suppressors comply with any particular component standard. However, attention is drawn to the IEC 61643 series of standards, in particular:

- IEC 61643-21 (surge suppressors in telecommunications application)
- IEC 61643-311 (gas discharge tubes)
- IEC 61643-321 (avalanche breakdown diodes)
- IEC 61643-331 (metal oxide varistors).

5.5.8 Insulation between the mains and an external circuit consisting of a coaxial cable

The insulation between the **mains** and the connection to a coaxial cable, including any resistor in parallel with this insulation, shall be able to withstand surges from the **external circuit** and from the **mains**.

This requirement does not apply in any of the following equipment:

- equipment for indoor use provided with a built-in (integral) antenna and not provided with a connection to a coaxial cable; or
- equipment connected to a reliable earth in accordance with 5.6.7.

The combination of the insulation with the resistor is tested after the conditioning of G.10.3.1 as follows:

- *for equipment intended to be connected to a coaxial cable connected to an outdoor antenna, the voltage surge test of G.10.3.2; or*
- *for equipment intended to be connected to another coaxial cable, the impulse test of G.10.3.3; or*
- *for equipment intended to be connected to both an outdoor antenna and other coaxial connections, the voltage surge test of G.10.3.2 and the impulse test of G.10.3.3.*

After the tests:

- *the insulation shall comply with 5.4.5.3 and the resistor may be removed during this test; and*
- *the resistors shall comply with G.10.3.4, unless available data shows compliance of the resistor.*

5.6 Protective conductor

5.6.1 General

Under **normal operating conditions**, a **protective conductor** may serve:

- as a **basic safeguard** to prevent **accessible** conductive parts from exceeding ES1 limits; and
- as a means to limit transient voltages in an earthed circuit.

Under **single fault conditions**, a **protective conductor** may serve as a **supplementary safeguard** to prevent **accessible** conductive parts from exceeding ES2 limits.

5.6.2 Requirements for protective conductors

5.6.2.1 General requirements

Protective conductors shall not contain switches, current limiting devices or overcurrent protective devices.

The current-carrying capacity of **protective conductors** shall be adequate for the duration of the fault current under **single fault conditions**.

The connections for the **protective conductors** shall make earlier and shall break later than the supply connections in each of the following:

- a connector (on a cable) or a connector attached to a part or a subassembly that can be removed by other than a **skilled person**;

NOTE It is good practice that this construction also be applied when it is expected that the **skilled person** will replace powered parts and assemblies while the equipment is operational.

- a plug on a power supply cord;
- an appliance coupler.

Solder shall not serve as the sole means to provide mechanical securement of the **protective conductor**.

The **protective conductor** termination shall be made such that it is not likely to be loosened during servicing, other than servicing of the actual conductor itself. The **protective earthing conductor** termination shall not serve as a means to fix any other component.

5.6.2.2 Colour of insulation

The insulation of the **protective earthing conductor** shall be green-and-yellow.

If a **protective bonding conductor** is insulated, the insulation shall be green-and-yellow except in the following two cases:

- for an earthing braid, the insulation, if provided, may be transparent;
- a **protective bonding conductor** in assemblies such as ribbon cables, bus bars, printed wiring, etc., may be of any colour provided that no misinterpretation of the use of the conductor is likely to arise.

Compliance is checked by inspection.

5.6.3 Requirements for protective earthing conductors

Protective earthing conductors shall comply with the minimum conductor sizes in Table G.5.

NOTE 1 For **permanently connected equipment** provided with terminal(s) for connection to **mains** supply, reference is made to the national building wiring requirements for the size of the **protective earthing conductor**.

NOTE 2 IEC 60364-5-54 can also be used to determine the minimum conductor size.

For cord connected equipment supplied from a d.c. **mains**, the protective earth connection may be provided by a separate terminal.

A **protective earthing conductor** serving as a **reinforced safeguard** may be used on **pluggable equipment type B** or on **permanently connected equipment** only and shall:

- be included in and protected by a sheathed supply cord that complies with G.7.1 and which is not lighter than heavy duty; or

NOTE 3 Heavy duty is defined in either IEC 60227-1 or IEC 60245-1.

- have a minimum conductor size not less than 4 mm² if not protected from physical damage; or
- have a minimum conductor size not less than 2,5 mm² if protected from physical damage; or

- be protected by a conduit intended to be connected to the equipment and have a minimum size in accordance with Table 30.

NOTE 4 For **mains** supply cords, see also Clause G.7.

NOTE 5 A heavy duty cord jacket is considered suitable for protection against physical damage.

Table 30 – Protective earthing conductor sizes for reinforced safeguards for permanently connected equipment

Protection provided by	Minimum protective earthing conductor size mm ²
Non-metallic flexible conduit	4
Metallic flexible conduit	2,5
Non-flexible metal conduit	1,5
The protective earthing conductor is intended for installation by a skilled person .	

A **protective earthing conductor** serving as a **double safeguard** may be used on **pluggable equipment type B** or on **permanently connected equipment** only and shall consist of two independent **protective earthing conductors**.

*Compliance is checked by inspection and measurement of **protective earthing conductor** sizes in accordance with Table 30 or Table G.5 as applicable.*

5.6.4 Requirements for protective bonding conductors

5.6.4.1 Requirements

Protective bonding conductors of parts required to be earthed for safety purposes shall comply with one of the following:

- the minimum conductor sizes in Table G.5; or
- the requirements of 5.6.6 and, if the **rated current** of the equipment or the **protective current rating** of the circuit is more than 25 A, with the minimum conductor sizes in Table 31; or
- the requirements of 5.6.6 and, if the **rated current** of the equipment or the **protective current rating** of the circuit does not exceed 25 A; either
 - with the minimum conductor sizes in Table 31; or
 - with the limited short-circuit test of Annex R;
- for components only, be not smaller than the conductors supplying power to the component.

NOTE The value of the **protective current rating** is used in Table 31 and in the test of 5.6.6.2.

Table 31 – Minimum protective bonding conductor size of copper conductors

Smaller of the rated current of the equipment or the protective current rating of the circuit under consideration A up to and including	Minimum conductor sizes	
	Cross-sectional area mm ²	AWG [cross-sectional area in mm ²]
3	0,3	22 [0,324]
6	0,5	20 [0,519]
10	0,75	18 [0,8]
13	1,0	16 [1,3]
16	1,25	16 [1,3]
25	1,5	14 [2]
32	2,5	12 [3]
40	4,0	10 [5]
63	6,0	8 [8]
80	10	6 [13]
100	16	4 [21]
125	25	2 [33]
160	35	1 [42]
190	50	0 [53]
230	70	000 [85]
260	95	0000 [107]
		kcmil [cross-sectional area in mm ²]
300	120	250 [126]
340	150	300 [152]
400	185	400 [202]
460	240	500 [253]

NOTE AWG and kcmil sizes are provided for information only. The associated cross-sectional areas have been rounded to show significant figures only. AWG refers to the American Wire Gage and the term "cmil" refers to circular mils where one circular mil is equal to (diameter in mils)². These terms are commonly used to designate wire sizes in North America.

5.6.4.2 Determination of the protective current rating

5.6.4.2.1 Mains supply as the source

Where the source is the **mains** supply, the **protective current rating** of the circuit is the rating of the overcurrent protective device provided in the building installation, or as part of the equipment.

Where the overcurrent protective device is provided in the building installation, then:

- for **pluggable equipment type A**, the **protective current rating** is the rating of an overcurrent protective device provided external to the equipment (for example, in the building wiring, in the **mains** plug or in an equipment rack), with a minimum of 16 A;

NOTE 1 In most countries, 16 A is considered to be suitable as the **protective current rating** of the circuit supplied from the **mains**.

NOTE 2 In Canada and the USA, the **protective current rating** of the circuit supplied from the **mains** is taken as 20 A.

NOTE 3 In the UK and Ireland the **protective current rating** is taken to be 13 A, this being the largest rating of fuse used in the **mains** plug.

- for **pluggable equipment type B**, and **permanently connected equipment** the **protective current rating** is the maximum rating of the overcurrent protective device specified in the equipment installation instructions to be provided external to the equipment.

5.6.4.2.2 Other than mains supply as the source

Where the source is an external supply having the maximum current inherently limited by the internal source impedance (such as an impedance protected transformer), the **protective current rating** of the circuit is the highest current available from that supply into any load.

Where the maximum current from the external supply source is limited by electronic components in the source, the **protective current rating** shall be taken as the maximum output current with any resistive load, including a short-circuit. If the current is limited by an impedance, a fuse, a PTC device or a circuit breaker, the current is measured 60 s after the application of the load. If the current is limited by other means, the current is measured 5 s after the application of the load.

5.6.4.2.3 Internal circuit as the source

Where the source is a circuit within the equipment, the **protective current rating** of the circuit is:

- the rating of the overcurrent protective device if the current is limited by an overcurrent protective device; or
- the maximum output current, if the current is limited by the source impedance of the supply. The output current is measured with any resistive load including a short-circuit measured 60 s after the application of the load if current is limited by impedance or the current limiting device is a fuse, a circuit breaker or a PTC device, or 5 s in other cases.

5.6.4.3 Current limiting and overcurrent protective devices

The current limiting device (a PTC device) or the overcurrent protective device (a fuse or a circuit breaker) shall not be connected in parallel with any other component that could fail to a low-resistance state.

5.6.4.4 Compliance criteria

*Compliance is checked by inspection and measurement of the **protective bonding conductor** sizes in accordance with Table 31 or Table G.5 and the test of 5.6.6 or Annex R as applicable.*

5.6.5 Terminals for protective conductors

5.6.5.1 Requirements

Terminals for connecting **protective earthing conductors** shall comply with the minimum terminal sizes in Table 32.

Terminals for connecting **protective bonding conductors** shall comply with one of the following:

- the minimum terminal sizes in Table 32; or
- the requirements of 5.6.6 and, if the **rated current** of the equipment or the **protective current rating** of the circuit is more than 25 A, with terminal sizes that are not more than one size smaller than in Table 32; or
- the requirements of 5.6.6 and, if the **rated current** of the equipment or the **protective current rating** of the circuit does not exceed 25 A; either

- with terminal sizes that are not more than one size smaller than in Table 32; or
 - with the limited short-circuit test of Annex R;
- for components only, be not smaller than the terminal sizes supplying power to the component.

Table 32 – Sizes of terminals for protective conductors

Conductor size mm ² (from Table G.5)	Minimum nominal thread diameter mm		Area of cross section mm ²	
	Pillar type or stud type	Screw type ^a	Pillar type or stud type	Screw type ^a
1	3,0	3,5	7	9,6
1,5	3,5	4,0	9,6	12,6
2,5	4,0	5,0	12,6	19,6
4	4,0	5,0	12,6	19,6
6	5,0	5,0	19,6	19,6
10 ^b	6,0	6,0	28	28
16 ^b	7,9	7,9	49	49

^a "Screw type" refers to a terminal that clamps the conductor under the head of a screw, with or without a washer.

^b As an alternative to the requirements of this table, the **protective earthing conductor** may be attached to special connectors, or suitable clamping means (for example, an upturned spade or closed loop pressure type; clamping unit type; saddle clamping unit type; mantle clamping unit type; etc.) that is secured by a screw and nut mechanism to the metal chassis of the equipment. The sum of the cross-sectional areas of the screw and the nut shall not be less than three times the cross-sectional area of the conductor size in Table 31 or Table G.5 as applicable. The terminals shall comply with IEC 60998-1 and IEC 60999-1 or IEC 60999-2.

Compliance is checked by inspection and measurement of protective terminal sizes in accordance with Table 32, the test of 5.6.6 or Annex R as applicable.

5.6.5.2 Corrosion

Conductive parts in contact at the main protective earthing terminal, protective bonding terminals and connections shall be selected in accordance with Annex N so that the potential difference between any two different metals is 0,6 V or less.

Compliance is checked by inspection of the materials of the conductors and terminals and associated parts and determination of the potential difference.

5.6.6 Resistance of the protective bonding system

5.6.6.1 Requirements

Protective bonding conductors and their terminations shall not have excessive resistance.

NOTE A protective bonding system in the equipment consists of a single conductor or a combination of conductive parts, connecting a main protective earthing terminal to a part of the equipment that is to be earthed for safety purposes.

Protective bonding conductors that meet the minimum conductor sizes in Table G.5 throughout their length and whose terminals all meet the minimum sizes in Table 32 are considered to comply without test.

On equipment where the protective earth connection to a subassembly or to a separate unit is made by means of one core of a multicore cable that also supplies power to that subassembly or unit and where the cable is protected by a suitably rated protective device that takes into account the size of the conductor, the resistance of the **protective bonding conductor** in that cable is not included in the measurement.

5.6.6.2 Test method

The test current can be either a.c. or d.c. and the test voltage shall not exceed 12 V. The measurement is made between the main protective earthing terminal and the point in the equipment that is required to be earthed.

The resistance of the **protective earthing conductor** and of any earthed conductor in other external wiring is not included in the measurement. However, if the **protective earthing conductor** is supplied with the equipment, the conductor may be included in the test circuit but the measurement of the voltage drop is made only from the main protective earthing terminal to the part required to be earthed.

Care is taken that the contact resistance between the tip of the measuring probe and the conductive part under test does not influence the test results. The test current and duration of the test are as follows:

- a) For equipment powered from the **mains** where the **protective current rating** of the circuit under test is 25 A or less, the test current is 200 % of the **protective current rating** applied for 2 min.
- b) For equipment powered from the **mains** where the **protective current rating** of the circuit under test exceeds 25 A, the test current is 200 % of the **protective current rating** or 500 A, whichever is less, and the duration of the test is as shown in Table 33.

Table 33 – Test duration, mains connected equipment

Protective current rating of the circuit A up to and including	Duration of the test min
30	2
60	4
100	6
200	8
over 200	10

- c) As an alternative to b), the tests are based on the time-current characteristic of the overcurrent protective device that limits the fault current in the **protective bonding conductor**. This device is either one provided in the EUT or specified in the installation instructions to be provided external to the equipment. The tests are conducted at 200 % of the **protective current rating**, for the duration corresponding to 200 % on the time-current characteristic. If the duration for 200 % is not given, the nearest point on the time-current characteristic may be used.
- d) For equipment powered from a d.c. **mains**, if the **protective current rating** of the circuit under test exceeds 25 A, the test current and duration are as specified by the manufacturer.
- e) For equipment receiving its power from an **external circuit**, the test current is 1,5 times the maximum current available from the **external circuit** or 2 A, whichever is greater, for a duration of 2 min. For parts connected to the **protective bonding conductor** to limit the transients or to limit **touch current** to an **external circuit** and that do not exceed an ES2 level during **single fault conditions**, the test is conducted in accordance with the relevant test method of either a), b), c) or d) based on the power source assumed.

5.6.6.3 Compliance criteria

Where the **protective current rating** is less than 25 A, the resistance of the protective bonding system, calculated from the voltage drop, shall not exceed 0,1 Ω .

Where the **protective current rating** is 25 A or more, the voltage drop over the protective bonding system shall not exceed 2,5 V.

5.6.7 Reliable earthing

For **permanently connected equipment** earthing is considered to be reliable.

For cord connected **mains** equipment, earthing is also considered to be reliable for:

- **pluggable equipment type B**; or
- **stationary pluggable equipment type A**,
 - that is intended to be used in a location having equipotential bonding (such as a telecommunication centre, a dedicated computer room, or a **restricted access area**); and
 - has installation instructions that require verification of the protective earthing connection of the socket-outlet by a **skilled person**; or
- **stationary pluggable equipment type A** that has provision for a permanently connected **protective earthing conductor**, including instructions for the installation of that conductor to building earth by a **skilled person**.

For equipment connected to an **external circuit** as indicated in Table 14, ID numbers 1, 2, 3, 4 and 5, earthing is considered to be reliable for **pluggable equipment type A** and **pluggable equipment type B** that have provision for a permanently connected **protective earthing conductor**, including instructions for the installation of that conductor to building earth by a **skilled person**.

5.7 Prospective touch voltage, touch current and protective conductor current

5.7.1 General

Measurements of **prospective touch voltage**, **touch current**, and **protective conductor current** are made with the EUT operating at the most unfavourable supply voltage (see B.2.3).

5.7.2 Measuring devices and networks

5.7.2.1 Measurement of touch current

For measurements of **touch current**, the instrument used for measuring U_2 and U_3 specified in Figures 4 and 5 respectively in IEC 60990:1999 shall indicate peak voltage. If the **touch current** waveform is sinusoidal, an r.m.s. indicating instrument may be used.

5.7.2.2 Measurement of voltage

Equipment, or parts of equipment, that are intended to be earthed in the intended application, but are unearthed as provided, shall be connected to earth during the measurement at the point by which the highest **prospective touch voltage** is obtained.

5.7.3 Equipment set-up, supply connections and earth connections

The equipment set-up, equipment supply connections and equipment earthing shall be in accordance with Clause 4, 5.3 and 5.4 of IEC 60990:1999.

Equipment provided with a connection to earth separate from the **protective earthing conductor** shall be tested with that connection disconnected.

Systems of interconnected equipment with separate connections to the **mains** shall have each equipment tested separately.

Systems of interconnected equipment with one connection to the **mains** shall be tested as a single equipment.

NOTE Systems of interconnected equipment are specified in more detail in Annex A of IEC 60990:1999.

Equipment that is designed for multiple connections to the **mains**, where only one connection is required at a time, shall have each connection tested while the other connections are disconnected.

Equipment that is designed for multiple connections to the **mains**, where more than one connection is required, shall have each connection tested while the other connections are connected, with the **protective earthing conductors** connected together. If the **touch current** exceeds the limit in 5.2.2.2, the **touch current** shall be measured individually.

5.7.4 Earthed accessible conductive parts

At least one earthed **accessible** conductive part shall be tested for **touch current** following supply connection faults in accordance with 6.1 and 6.2.2 of IEC 60990:1999, except 6.2.2.7. Except as permitted in 5.7.6, the **touch current** shall not exceed the ES2 limits in 5.2.2.2.

Subclause 6.2.2.2 of IEC 60990:1999 does not apply to equipment with a switch or other **disconnect device** that disconnects all poles of the supply.

NOTE An appliance coupler is an example of a **disconnect device**.



5.7.5 Protective conductor current

The **protective conductor current** shall not exceed the ES2 limits in 5.2.2.2, unless all of the following conditions are met:

- the current shall not exceed 5 % of the input current measured under **normal operating conditions**;
- the construction of the **protective conductor** circuit and its connections shall have:
 - a **protective earthing conductor** serving as a **reinforced safeguard** or two independent **protective earthing conductors** serving as **double safeguard** as specified in 5.6.3, and
 - a reliable earthing as specified in 5.6.7.

If the **protective conductor current** exceeds the ES2 limits of 5.2.2.2, then an **instructional safeguard** shall be provided in accordance with Clause F.5, except that element 3 is optional.

The elements of the **instructional safeguard** shall be as follows:

- element 1a:  , IEC 60417-6042 (2010-11) and  , IEC 60417-6173 (2012-10) and  , IEC 60417-5019 (2006-08)
- element 2: “Caution” or equivalent word or text, and “High touch current” or equivalent text
- element 3: optional
- element 4: “Connect to earth before connecting to supply” or equivalent text

The **instructional safeguard** shall be affixed to the equipment adjacent to the equipment supply connection.

NOTE In Denmark the installation instruction shall be affixed to the equipment if the **protective conductor current** exceeds the limits of 3,5 mA a.c. or 10 mA d.c.

5.7.6 Prospective touch voltage and touch current due to external circuits

5.7.6.1 Touch current from coaxial cables

For **external circuits** connected to a coaxial cable, the manufacturer shall provide instructions to connect the shield of the coaxial cable to building earth in accordance with 6.2 g) and 6.2 l) of IEC 60728-11:2005.

NOTE 1 In Norway and Sweden, the screen of the television distribution system is normally not earthed at the entrance of the building and there is normally no equipotential bonding system within the building. Therefore the protective earthing of the building installation needs to be isolated from the screen of a cable distribution system.

It is however accepted to provide the insulation external to the equipment by an adapter or an interconnection cable with galvanic isolator, which may be provided by a retailer, for example.

The user manual shall then have the following or similar information in Norwegian and Swedish language respectively, depending on in what country the equipment is intended to be used in:

“Apparatus connected to the protective earthing of the building installation through the mains connection or through other apparatus with a connection to protective earthing – and to a television distribution system using coaxial cable, may in some circumstances create a fire hazard. Connection to a television distribution system therefore has to be provided through a device providing electrical isolation below a certain frequency range (galvanic isolator, see EN 60728-11)”

NOTE 2 In Norway, due to regulation for CATV-installations, and in Sweden, a galvanic isolator shall provide electrical insulation below 5 MHz. The insulation shall withstand a dielectric strength of 1,5 kV r.m.s., 50 Hz or 60 Hz, for 1 minute.

Translation to Norwegian (the Swedish text will also be accepted in Norway):

“Apparater som er koplet til beskyttelsesjord via nettplugg og/eller via annet jordtilkoplet utstyr – og er tilkoplet et koaksialbasert kabel-TV nett, kan forårsake brannfare. For å unngå dette skal det ved tilkopling av apparater til kabel-TV nett installeres en galvanisk isolator mellom apparatet og kabel-TV nettet.”

Translation to Swedish:

“Apparater som är kopplad till skyddsjord via jordat vägguttag och/eller via annan utrustning och samtidigt är kopplad till kabel-TV nät kan i vissa fall medföra risk för brand. För att undvika detta skall vid anslutning av apparaten till kabel-TV nät galvanisk isolator finnas mellan apparaten och kabel-TV nätet.”

5.7.6.2 Prospective touch voltage and touch current from external circuits

For **external circuits** ID 1 of Table 14:

- the **prospective touch voltage** shall comply with ES2; or
- the **touch current** shall not exceed 0,25 mA.

The above requirements do not apply to **external circuits** connected to a **protective earthing conductor**.

Compliance is checked by measurement according 5.7.2 and 5.7.3 by using the measurement arrangement in Figure 32 for single-phase equipment and Figure 33 for three-phase equipment.

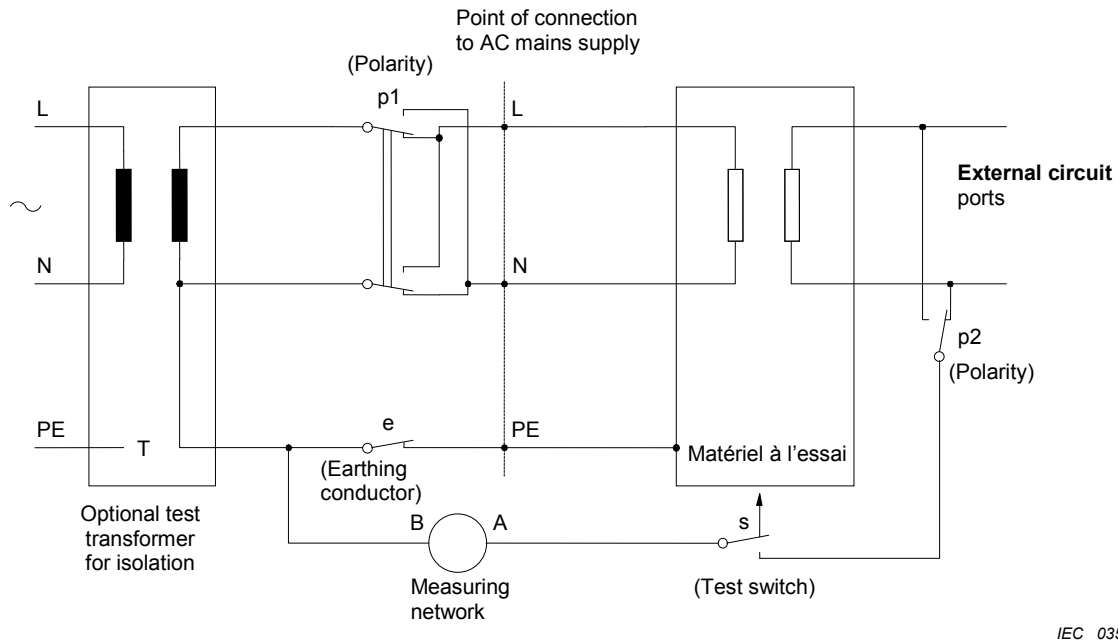

IEC 0355/14

Figure 32 – Test circuit for touch current of single-phase equipment

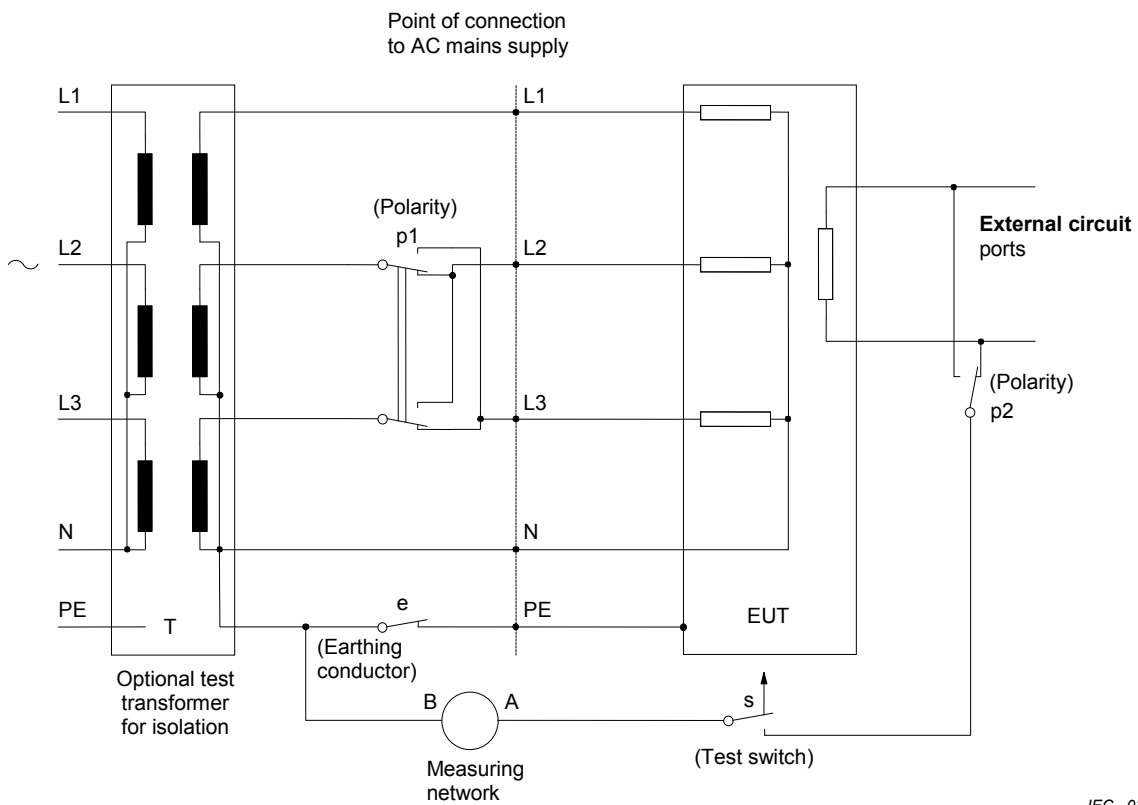

IEC 0356/14

Figure 33 – Test circuit for touch current of three-phase equipment

5.7.7 Summation of touch currents from external circuits

The requirements below specify when a permanently connected **protective earthing conductor** is required for **pluggable equipment type A** or **pluggable equipment type B**, should the **mains** connection be disconnected.

The requirements apply only to equipment with **external circuits** such as described in Table 14, ID numbers 1, 2, 3 and 4.

NOTE These types of **external circuits** are typically telecommunication networks.

The summation of **touch currents** from equipment that provides multiple **external circuits**, shall not exceed the limits for ES2 (see Table 4).

The following abbreviations are used:

- I_1 : **touch current** received from other equipment via a network at an **external circuit** of the equipment;
- $S(I_1)$: summation of **touch current** received from other equipment at all such **external circuit** of the equipment;
- I_2 : **touch current** due to the **mains** of the equipment.

It shall be assumed that each **external circuit** receives 0,25 mA (I_1) from the other equipment, unless the actual current from the other equipment is known to be lower.

The following requirements, a) or b) as applicable, shall be met:

a) Equipment with earthed **external circuit**

For equipment in which each **external circuit** is connected to a terminal for the **protective earthing conductor** of the equipment, the following items 1), and 2) shall be considered:

- 1) If $S(I_1)$ (not including I_2) exceeds ES2 limits of Table 4:
 - the equipment shall have provision for a permanent connection to protective earth in addition to the **protective earthing conductor** in the power supply cord of **pluggable equipment type A** or **pluggable equipment type B**; and
 - the installation instructions shall specify the provision of a permanent connection to protective earth with a cross-sectional area of not less than 2,5 mm², if mechanically protected, or otherwise 4,0 mm²; and
 - provide a marking in accordance with 5.7.5 and Clause F.3.
- 2) Such equipment shall comply with 5.7.5. The value of I_2 shall be used to calculate the 5 % input current limit per phase specified in 5.7.5.

Compliance with item a) is checked by inspection and if necessary by test.

If the equipment has provision for a permanent protective earth connection in accordance with item 1) above, it is not necessary to make any measurements, except that I_2 shall comply with the relevant requirements of 5.7.

***Touch current tests**, if necessary, are made using the relevant measuring instrument described in IEC 60990:1999, Figure 5, or any other instrument giving the same results. A capacitively coupled a.c. source of the same line frequency and phase as the a.c. **mains** is applied to each **external circuit** so that 0,25 mA, or the actual current from other equipment if known to be lower, is available to flow into that **external circuit**. The current flowing in the earthing conductor is then measured.*

b) Equipment whose **external circuit** have no reference to protective earth

If each **external circuit** does not have a common connection, the **touch current** for each **external circuit** shall not exceed ES2 limits of Table 4.

If all **external circuits** or any groups of such ports have a common connection, the total **touch current** from each common connection shall not exceed ES2 limits of Table 4.

Compliance with item b) is checked by inspection and if there are common connection points, by the following test.

*A capacitively coupled a.c. source of the same frequency and phase as the a.c. **mains** is applied to each **external circuit** so that 0,25 mA, or the actual current from the other equipment if known to be lower, is available to flow into that **external circuit**. Common connection points are tested in accordance with 5.7.3, whether or not the points are **accessible**.*

6 Electrically-caused fire

6.1 General

To reduce the likelihood of injury or property damage due to an electrically-caused fire originating within the equipment, equipment shall be provided with the **safeguards** specified in Clause 6.

6.2 Classification of power sources (PS) and potential ignition sources (PIS)

6.2.1 General

Electrical sources of heating can be classified into available power levels PS1, PS2 and PS3 (see 6.2.2.4, 6.2.2.5 and 6.2.2.6) that may cause resistive heating of both components and connections. These power sources are based on available energy to a circuit.

Within a power source, a **PIS** may arise due to arcing of either broken connections or opening of contacts (**arcing PIS**) or from components dissipating more than 15 W (**resistive PIS**).

Depending on the power source classification of each circuit, one or more **safeguards** are required either to reduce the likelihood of ignition or to reduce the likelihood of spread of fire beyond the equipment.

6.2.2 Power source circuit classifications

6.2.2.1 General

An electric circuit is classified PS1, PS2, or PS3 based on the electrical power available to the circuit from the power source.

The electrical power source classification shall be determined by measuring the maximum power under each of the following conditions:

- for load circuits: a power source under **normal operating conditions** as specified by the manufacturer into a worst-case fault (see 6.2.2.2);
- for power source circuits: a worst-case power source fault into the specified normal load circuit (see 6.2.2.3).

The power is measured at points X and Y in Figure 34 and Figure 35.

6.2.2.2 Power measurement for worst-case fault

With reference to Figure 34:

- *the measurement may be performed without the load circuit I_{NL} connected, unless the maximum power is dependent on the connection of the load;*
- *at points X and Y, insert a wattmeter (or a voltmeter, V_A , and a current meter, I_A);*
- *connect a variable resistor, L_{VR} as shown;*
- *adjust the variable resistor, L_{VR} , for maximum power. Measure the maximum power and classify the power source according to 6.2.2.4, 6.2.2.5 or 6.2.2.6.*

If an overcurrent protective device operates during the test, the measurement shall be repeated at 125 % of the current rating of the overcurrent protective device.

If a power limiting circuit operates during the test, the measurement shall be repeated at a point just below the current at which the power limiting circuit operated.

When evaluating accessories connected via cables to the equipment, the impedance of the cable may be taken into account in the determination of PS1 or PS2 on the accessory side.

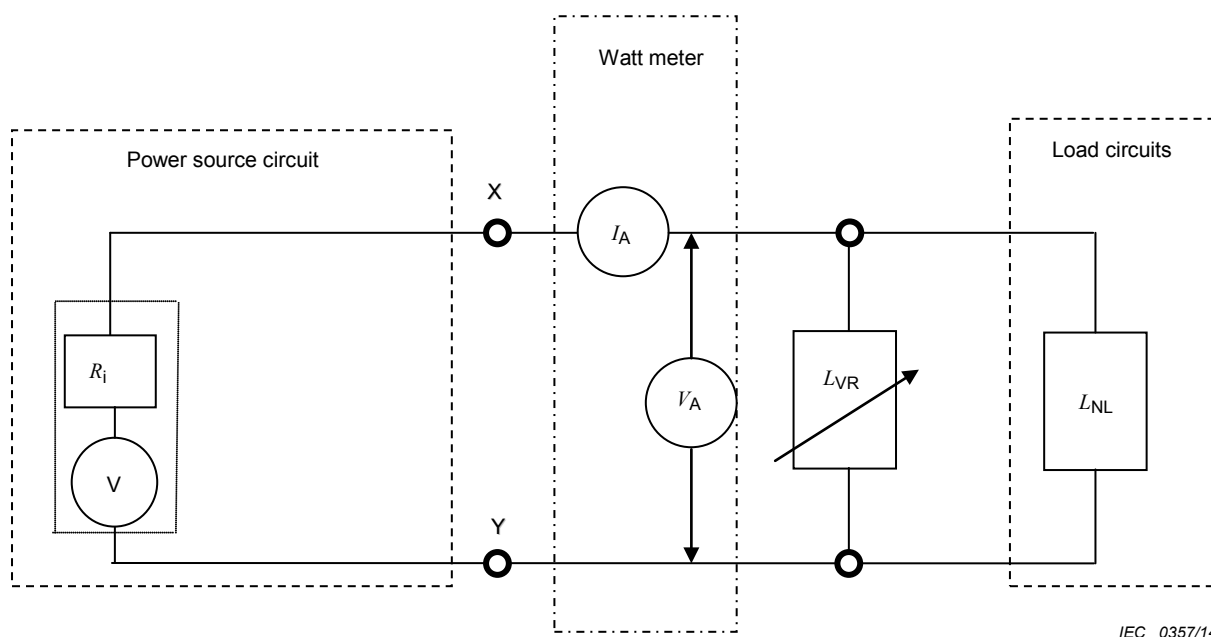

IEC 0357/14

Key

- V voltage source
- R_i internal resistance of the power source
- I_A current from the power source
- V_A voltage at the points where determination of PS power is made.
- L_{VR} variable resistor load
- L_{NL} normal load

Figure 34 – Power measurement for worst-case fault

6.2.2.3 Power measurement for worst-case power source fault

With reference to Figure 35:

- At points X and Y, insert a wattmeter (or a voltmeter, V_A , and a current meter, I_A).
- Within the power source circuit, simulate any **single fault condition** that will result in maximum power to the circuit being classified. All relevant components in the power source circuits shall be short-circuited or disconnected one at a time at each measurement.
- Measure the maximum power as specified and classify circuits supplied by the power source according to 6.2.2.4, 6.2.2.5 or 6.2.2.6.

If an overcurrent protective device operates during the test, the measurement shall be repeated at 125 % of the current rating of the overcurrent protective device.

If a power limiting circuit operates during the test, the measurement shall be repeated at a point just below the current at which the power limiting circuit operated.

When the tests are repeated, a variable resistance may be used to simulate the component under fault.

To avoid damage to the components of the normal load, a resistor (equal to the normal load) may be substituted for the normal load.

NOTE Experimentation can be necessary to identify the single component fault that produces maximum power.

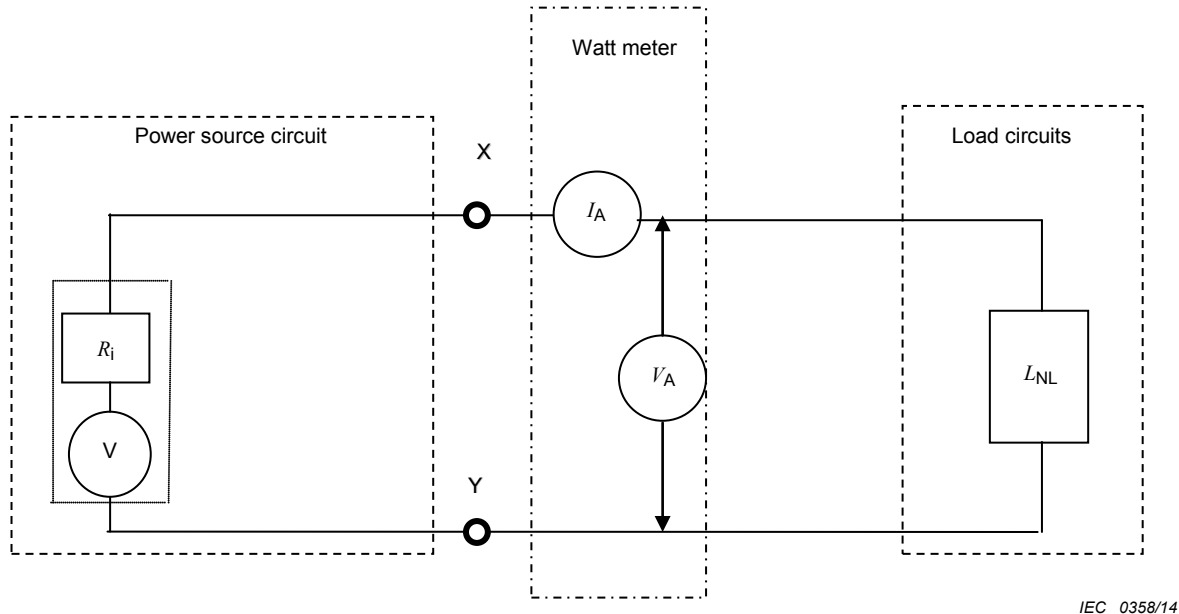

IEC 0358/14

Key

- V voltage source
- R_i internal resistance of the power source
- I_A current from the power source
- V_A voltage at the points where determination of PS power is made.
- L_{NL} normal load

Figure 35 – Power measurement for worst-case power source fault

6.2.2.4 PS1

PS1 is a circuit where the power source, (see Figure 36) measured according to 6.2.2, does not exceed 15 W measured after 3 s.

The power available from **external circuits** described in Table 14, ID numbers 1 and 2, are considered to be PS1.

6.2.2.5 PS2

PS2 is a circuit where the power source, (see Figure 36) measured according to 6.2.2:

- exceeds PS1 limits; and
- does not exceed 100 W measured after 5 s.

6.2.2.6 PS3

PS3 is a circuit whose power source exceeds PS2 limits, or any circuit whose power source has not been classified (see Figure 36).

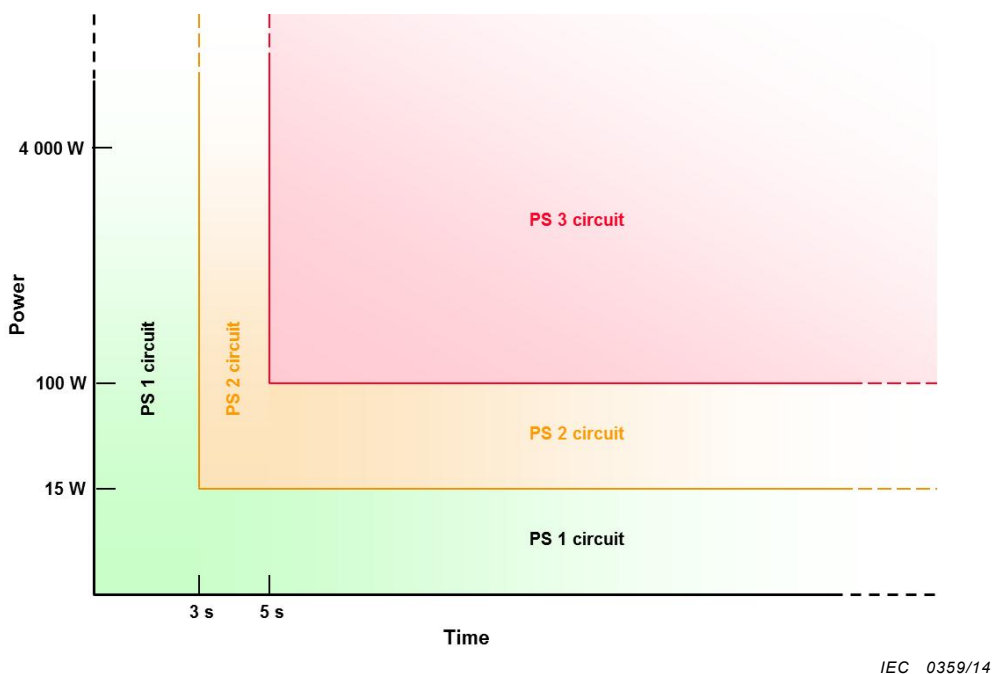

Figure 36 – Illustration of power source classification

6.2.3 Classification of potential ignition sources

6.2.3.1 Arcing PIS

Determination of an **arcing PIS** is performed under **normal operating conditions** unless otherwise specified.

An **arcing PIS** is a location with the following characteristics:

- an open circuit voltage (measured after 3 s) across an open conductor or opening electrical contact exceeding 50 V (peak) a.c. or d.c.; and
- the product of the peak of the open circuit voltage (V_p) and the measured r.m.s. current (I_{rms}) exceeds 15 (that is, $V_p \times I_{rms} > 15$) for any of the following:
 - a contact, such as a switch or connector;
 - a termination, such as one made by a crimp, spring or solder termination;
 - opening of a conductor, such as a printed wiring board trace, as a consequence of a **single fault condition**. This condition does not apply if electronic protection circuits or additional constructional measures are used to reduce the likelihood that such a fault becomes an **arcing PIS**.

An **arcing PIS** is considered not to exist in a PS1 because of the limits of the power source.

NOTE 1 An open conductor in an electric circuit includes those interruptions that occur in conductive patterns on printed boards.

Reliable or redundant connections are not considered to be an **arcing PIS**.

Redundant connections are any kind of two or more connections in parallel, where in the event of the failure of one connection, the remaining connections are still capable of handling the full power.

Reliable connections are connections that are considered not to open.

NOTE 2 Examples of connections that could be considered reliable are:

- holes of solder pads on a printed board that are through-metallized;
- tubular rivets/eyelets that are additionally soldered;
- machine-made or tool-made crimp or wire-wrap connections.

NOTE 3 Other means to avoid the occurrence of an **arcing PIS** can be used.

NOTE 4 Connection failure due to thermal fatigue phenomena could be prevented by selection of components with a coefficient of thermal expansion similar to that of the printed board material, taking into account the location of the component with respect to the fibre direction of the board material.

6.2.3.2 Resistive PIS

Determination of a **resistive PIS** is performed under **normal operating conditions** unless otherwise specified.

A **resistive PIS** is any part in a PS2 or PS3 circuit that:

- dissipates more than 15 W measured after 30 s of normal operation; or

NOTE During the first 30 s there is no limit.

- under **single fault conditions**:
 - has a power exceeding 100 W measured during the 30 s immediately after the introduction of the fault if electronic circuits, regulators or PTC devices are used, or
 - has an available power exceeding 15 W measured 30 s after the introduction of the fault.

A **resistive PIS** is considered not to exist in a PS1 because of the limits of the power source.

6.3 Safeguards against fire under normal operating conditions and abnormal operating conditions

6.3.1 Requirements

Under **normal operating conditions** and **abnormal operating conditions**, the following **basic safeguards** are required:

- ignition shall not occur; and
- no part of the equipment shall attain a temperature value greater than 90 % of the spontaneous ignition temperature limit, in Celsius, of the part as defined by ISO 871. When the spontaneous ignition temperature of the material is not known, the temperature shall be limited to 300 °C; and

NOTE This standard currently does not contain requirements for flammable liquids and dust.

- **combustible materials** for components and other parts outside **fire enclosures** (including **electrical enclosures**, **mechanical enclosures** and decorative parts), shall have a **material flammability class** of at least:
 - **HB75** if the thinnest significant thickness of this material is < 3 mm, or
 - **HB40** if the thinnest significant thickness of this material is ≥ 3 mm, or
 - **HBF**.

These requirements do not apply to:

- parts with a size of less than 1 750 mm³;
- supplies, **consumable materials**, media and recording materials;
- parts that are required to have particular properties in order to perform intended functions, such as synthetic rubber rollers and ink tubes;
- gears, cams, belts, bearings and other parts that would contribute negligible fuel to a fire, including, labels, mounting feet, key caps, knobs and the like.

6.3.2 Compliance criteria

*Compliance is checked by inspection of the data sheets and by test under **normal operating conditions** according to Clause B.2 and under **abnormal operating conditions** according to Clause B.3. The temperatures of materials are measured continuously until thermal equilibrium has been attained.*

NOTE See B.1.6 for details on thermal equilibrium.

*Temperature limiting **basic safeguards** that comply with the applicable requirements of this standard or the applicable safety device standard shall remain in the circuit being evaluated.*

6.4 Safeguards against fire under single fault conditions

6.4.1 General

This subclause defines the possible **safeguard** methods that can be used to reduce the likelihood of ignition or spread of fire under **single fault conditions**.

There are two methods of providing protection. Either method may be applied to different circuits of the same equipment under the following conditions:

- **Reduce the likelihood of ignition:** Equipment is so designed that under **single fault conditions** no part shall have sustained flaming. This method can be used for any circuit in which the available steady state power to the circuit does not exceed 4 000 W. The appropriate requirements and tests are detailed in 6.4.2 and 6.4.3.
 - **Pluggable equipment type A** is considered not to exceed the steady state value of 4 000 W.
 - **Pluggable equipment type B** and **permanently connected equipment** are considered not to exceed the steady state value of 4 000 W if the product of the nominal **mains** voltage and the **protective current rating** of the installation overcurrent protective device ($V_{\text{mains}} \times I_{\text{max}}$) does not exceed 4 000 W.
- **Control fire spread:** Selection and application of **supplementary safeguards** for components, wiring, materials and constructional measures that reduce the spread of fire and, where necessary, by the use of a second **supplementary safeguard** such as a **fire enclosure**. This method can be used for any type of equipment. The appropriate requirements are detailed in 6.4.4, 6.4.5 and 6.4.6.

6.4.2 Reduction of the likelihood of ignition under single fault conditions in PS1 circuits

No **supplementary safeguards** are needed for protection against PS1. A PS1 is not considered to contain enough energy to result in materials reaching ignition temperatures.

6.4.3 Reduction of the likelihood of ignition under single fault conditions in PS2 circuits and PS3 circuits

6.4.3.1 General

Requirements for **supplementary safeguards** needed to reduce the likelihood of ignition under **single fault conditions** in PS2 circuits and PS3 circuits where the available power does not exceed 4 000 W (see 6.4.1) are specified in 6.4.3.2.

6.4.3.2 Requirements

The likelihood of ignition can be reduced by using the following **supplementary safeguards** as applicable:

- providing separation from an **arcing PIS** or a **resistive PIS** as specified in 6.4.7;
- using protective devices that comply with G.3.1 to G.3.4 or the relevant IEC component standards for such devices;
- using components that comply with G.5.3, G.5.4 or the relevant IEC component standard;
- for components associated with the **mains**, using components that comply with the relevant IEC component standards and requirements of other parts of this standard.

NOTE Examples of components associated with the **mains** are the supply cord, appliance couplers, EMC filtering components, switches, etc.

The opening of a conductor on a printed board, except as specified below, shall not be used as a **safeguard**.

Conductors of a printed board of **V-1 class material** may open under **overload condition** provided that the open circuit is not an **arcing PIS**. Conductors on a printed board material that has no **material flammability class** or is classed lower than **V-1 class material** shall not open.

Under a **single fault condition**, the peeling of conductors on a printed board shall not result in the failure of any **supplementary safeguard** or **reinforced safeguard**.

6.4.3.3 Test method

The conditions of Clause B.4, that are possible causes for ignition, are applied in turn. A consequential fault may either interrupt or short-circuit a component. In case of doubt, the test shall be repeated two more times with replacement components in order to check that sustained flaming does not occur.

*The equipment is operated under **single fault conditions** and the temperatures of materials are measured continuously until thermal equilibrium has been attained.*

*If a conductor opens during a simulated **single fault condition**, the conductor shall be bridged and the simulated **single fault condition** shall be continued. In all other cases, where an applied **single fault condition** results in interruption of the current before steady state has been reached, the temperatures are measured immediately after the interruption.*

NOTE 1 See B.1.6 for details on thermal equilibrium.

Spontaneous ignition temperatures of surrounding materials of the heat source shall be taken into account.

NOTE 2 Temperature rise can be observed after interruption of the current due to thermal inertia.

*If the temperature is limited by a fuse, under a **single fault condition***

- *a fuse complying with the IEC 60127 series shall open within 1 s; or*
- *a fuse not complying with the IEC 60127 series shall open within 1 s for three consecutive times; or*
- *the fuse shall comply with the following test.*

*The fuse is short-circuited and the current that would have passed through the fuse under the relevant **single fault condition** is measured.*

- *If the fuse current remains less than 2,1 times the current rating of the fuse, the temperatures are measured after a steady state has been attained.*
- *If the current either immediately reaches 2,1 times the current rating of the fuse or more, or reaches this value after a period of time equal to the maximum pre-arcing time for the relevant current through the fuse under consideration, both the fuse and the short-circuit link are removed after an additional time corresponding to the maximum pre-arcing time of the fuse under consideration and the temperatures are measured immediately thereafter.*

If the fuse resistance influences the current of the relevant circuit, the maximum resistance value of the fuse shall be taken into account when establishing the value of the current.

*Printed board conductors are tested by applying the relevant **single fault conditions** of B.4.4.*

6.4.3.4 Compliance criteria

Compliance is checked by inspection, tests and measurements.

6.4.4 Control of fire spread in PS1 circuits

No **supplementary safeguards** are needed for protection against PS1. A PS1 is not considered to contain enough energy to result in materials reaching ignition temperatures.

6.4.5 Control of fire spread in PS2 circuits

6.4.5.1 General

For the purposes of reducing the likelihood of fire spread in PS2 circuits to nearby **combustible materials**, circuits that meet the requirements of Annex Q are considered to be PS2 circuits.

6.4.5.2 Requirements

A **supplementary safeguard** is required to control the spread of fire from any possible **PIS** to other parts of the equipment as given below.

For conductors and devices that constitute a **PIS** the following apply:

- printed boards shall be made of **V-1 class material** or **VTM-1 class material**;
- wire insulation and tubing shall comply with IEC 60332-1-2, IEC 60332-1-3, IEC 60332-2-2 or IEC/TS 60695-11-21;

All other components in a PS2 circuit shall:

- be mounted on **V-1 class material** or **VTM-1 class material**; or
- be made of **V-2 class material**, **VTM-2 class material** or **HF-2 class foamed material**; or
- have a mass of **combustible material** of less than 4 g, provided that when the part is ignited, the fire does not spread to another part; or
- be separated from **PIS** by the requirements of 6.4.7; or
- not ignite during **single fault conditions** as specified in 6.4.3.3; or
- comply with the requirements of the relevant IEC component standard; or
- comply with G.5.4 for motors; or
- comply with G.5.3 for transformers; or
- be in a sealed **enclosure** of 0,06 m³ or less, consisting totally of non-**combustible material** and having no ventilation openings.

The following materials shall be separated from a **PIS** according to the requirements of 6.4.7, or the materials shall not ignite during **single fault conditions** as specified in 6.4.3.3:

- supplies, **consumable materials**, media and recording materials;
- parts that are required to have particular properties in order to perform intended functions, such as synthetic rubber rollers and ink tubes.

6.4.5.3 Compliance criteria

Compliance is checked by testing or by inspection of the equipment and material data sheets.

6.4.6 Control of fire spread in a PS3 circuit

Fire spread in PS3 circuits shall be controlled by applying all of the following **supplementary safeguards**:

- conductors and devices within a PS3 circuit shall meet the requirements of 6.4.5;
- devices subject to arcing or changing contact resistance (for example, pluggable connectors) shall comply with one of the following:
 - have materials made of **V-1 class material**, or
 - comply with the flammability requirements of the relevant IEC component standard, or
 - be mounted on material made of **V-1 class material** and be of a volume not exceeding 1 750 mm³;
- by providing a **fire enclosure** as specified in 6.4.8.

Within the **fire enclosure**, **combustible materials** that are not part of a PS2 or PS3 circuit shall comply with the flammability test of Clause S.1 or be made of **V-2 class material**, **VTM-2 class material** or **HF-2 class foamed material**. These requirements do not apply to:

- parts with a size of less than 1 750 mm³;
- supplies, **consumable materials**, media and recording materials;
- parts that are required to have particular properties in order to perform intended functions, such as synthetic rubber rollers and ink tubes;
- gears, cams, belts, bearings and other parts that would contribute negligible fuel to a fire, including, labels, mounting feet, key caps, knobs and the like;
- tubing for air or fluid systems, containers for powders or liquids and foamed plastic parts, provided that they are of **HB75 class material** if the thinnest significant thickness of the material is < 3 mm, or **HB40 class material** if the thinnest significant thickness of the material is ≥ 3 mm, or **HBF class foamed material**.

A **fire enclosure** is not necessary for the following components and materials:

- wire insulation and tubing complying with IEC 60332-1-2, IEC 60332-1-3, IEC 60332-2-2 or IEC/TS 60695-11-21;
- components, including connectors, complying with the requirements of 6.4.8.2.1, and that fill an opening in a **fire enclosure**;
- plugs and connectors forming part of a power supply cord or interconnecting cable complying with 6.5, G.4.1 and Clause G.7;
- motors complying with G.5.4;
- transformers complying with G.5.3.

Compliance is checked by inspection of the material data sheets or by test or both.

6.4.7 Separation of combustible materials from a PIS

6.4.7.1 General

The minimum separation requirements between a **PIS** and **combustible materials**, in order to reduce the likelihood of sustained flaming or spread of fire, may be achieved by either separation by distance (6.4.7.2) or separation by a barrier (6.4.7.3).

Separation requirements from a **PIS** to a **fire enclosure** are specified in 6.4.8.4.

6.4.7.2 Separation by distance

Combustible material, except the material on which the **PIS** is mounted, shall be separated from an **arcing PIS** or a **resistive PIS** according to Figure 37, Figure 38, Figure 39 and Figure 40.

Base material of printed boards, on which an **arcing PIS** is located, shall be made of **V-1 class material**, **VTM-1 class material** or **HF-1 class foamed material**.

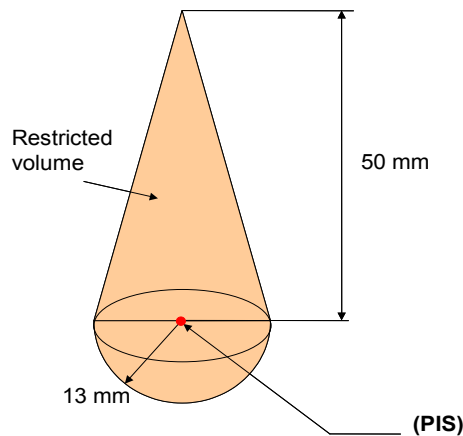

IEC 0360/14

Figure 37 – Minimum separation requirements from an arcing PIS

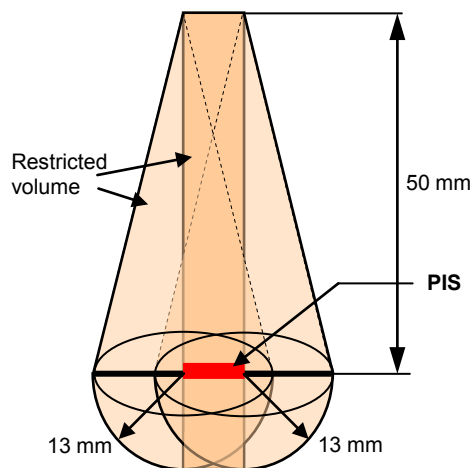

IEC 0361/14

NOTE This figure can be used for:

- an **arcing PIS** that consists of tracks or areas on printed boards;
- the **resistive PIS** areas of components. Measurements are made from the nearest power dissipating element of the component involved. If in practice it is not readily possible to define the power dissipating part, then the outer surface of the component is used.

Figure 38 – Extended separation requirements from a PIS

When the airflow across a circuit is moving due to air moving devices, the vertical orientation of the restricted volumes described in Figure 37, Figure 38 and Figure 40 shall be rotated to reflect the effect of the airflow on the flame path. When determining the restricted volumes for each figure, each cone shall be rotated (tilted) around the **PIS** location from 0° (vertical orientation, shown in Figure 39) to 45° in the direction of the forced airflow.

Any available data, including manufacturer's data, may be used in determining direction of forced airflow where it is not clear. Consequential air flow due to the by-product of a moving part that is not for air moving purposes may be ignored.

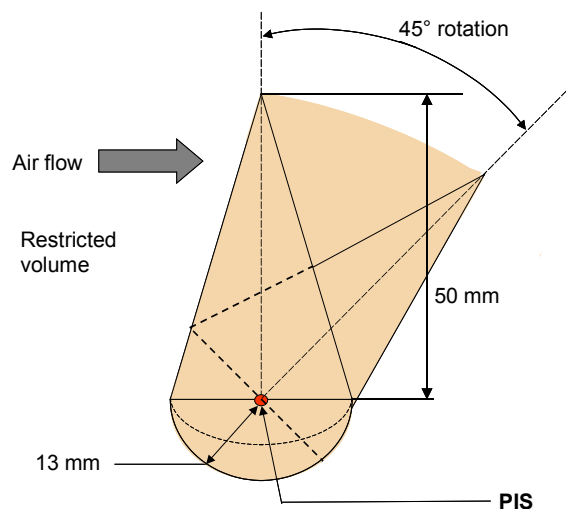

IEC 0362/14

Figure 39 – Rotated separation requirements due to forced air flow

When the distance between a **PIS** and **combustible materials** is less than specified in Figure 37, Figure 38 and Figure 39 as applicable, the **combustible materials** shall:

- have a mass of less than 4 g provided that when the part is ignited, the fire does not spread to another part; or
- comply with the following flammability requirements:
 - requirements of the relevant IEC component standard; or
 - be made of **V-1 class material**, **VTM-1 class material** or **HF-1 class foamed material**, or comply with IEC 60695-11-5. Severities are identified in Clause S.2.

6.4.7.3 Separation by a fire barrier

Combustible material shall be separated from an **arcing PIS** or a **resistive PIS** by a fire barrier as defined in 6.4.8.2.1 (see Figure 40).

Printed boards are not considered to be a fire barrier against an **arcing PIS** located on the same board. Printed boards complying with 6.4.8 may be considered to be a fire barrier against an **arcing PIS** located on a different board.

Printed boards can be considered to be a fire barrier against a **resistive PIS** provided that the following conditions are met:

- the printed board shall:
 - comply with the flammability test Clause S.1 as used in the application; or
 - be made of **V-1 class material**, **VTM-1 class material** or **HF-1 class foamed material**;

- within the restricted volume, no materials rated less than **V-1 class material** shall be mounted on the same side of a printed board as the **resistive PIS**;
- within the restricted volume, the printed board shall have no PS2 conductors or PS3 conductors (except for the conductors that supply the circuit under consideration). This applies to any side of the printed board as well as the inner layer of the printed board.

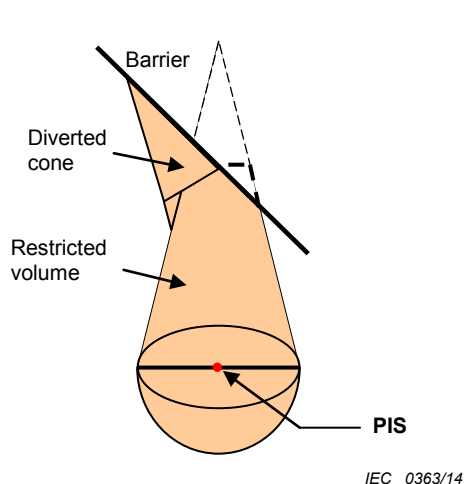

Figure 40a – Illustration showing an angled barrier

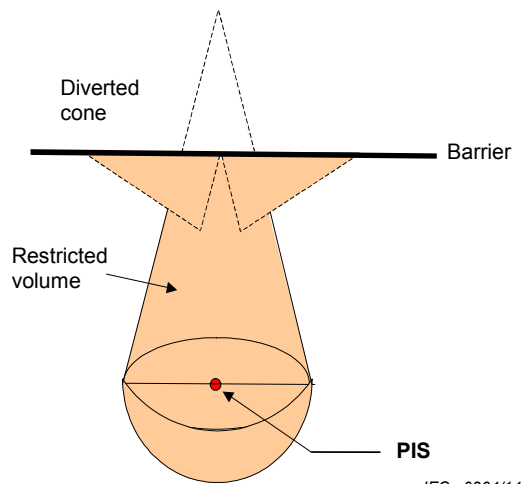

Figure 40b – Illustration showing a horizontal barrier

NOTE 1 The volume of the flame is nearly constant; consequently the shape of the flame is dependent upon the position and the shape of the barrier. Different shapes of barriers might give different flame shapes and result in a different restricted area and separation requirements.

NOTE 2 Dimensions are identical to Figure 37 and Figure 38 but, except as required in 6.4.8.4, the distance of the barrier from the **PIS** is not significant.

Figure 40 – Deflected separation requirements from a PIS when a fire barrier is used

6.4.7.4 Compliance criteria

Compliance is checked by inspection or measurement or both.

6.4.8 Fire enclosures and fire barriers

6.4.8.1 General

The **safeguard** function of the **fire enclosure** and the fire barrier is to impede the spread of fire through the **enclosure** or barrier.

The **fire enclosure** may be the overall **enclosure**, or it may be within the overall **enclosure**. The **fire enclosure** need not have an exclusive function, but may provide other functions in addition to that of a **fire enclosure**.

6.4.8.2 Fire enclosure and fire barrier material properties

6.4.8.2.1 Requirements for a fire barrier

A fire barrier shall comply with the requirements of Clause S.1.

These requirements do not apply provided that the material is:

- made of non-**combustible material** (for example, metal, glass, ceramic, etc.); or
- made of **V-1 class material** or **VTM-1 class material**.

6.4.8.2.2 Requirements for a fire enclosure

For circuits where the available power does not exceed 4 000 W (see 6.4.1), a **fire enclosure** shall comply with the requirements of Clause S.1.

For circuits where the available power exceeds 4 000 W, a **fire enclosure** shall comply with the requirements of Clause S.5.

These requirements do not apply provided that the material is:

- made of **non-combustible material** (for example, metal, glass, ceramic, etc.); or
- made of
 - **V-1 class material** if the available power does not exceed 4 000 W; or
 - **5VA class material** or **5VB class material** if the available power exceeds 4 000 W.

Material for components that fill an opening in a **fire enclosure** or that is intended to be mounted in such opening shall:

- comply with the flammability requirements of the relevant IEC component standard; or
- be made of **V-1 class material**; or
- comply with Clause S.1.

6.4.8.2.3 Compliance criteria

Compliance is checked by inspection of applicable data sheets or test.

*The **material flammability class** is checked for the thinnest significant thickness used.*

6.4.8.3 Constructional requirements for a fire enclosure and a fire barrier

6.4.8.3.1 Fire enclosure and fire barrier openings

Openings in a **fire enclosure** or in a fire barrier shall be of such dimensions that fire and products of combustion passing through the openings are not likely to ignite material on the outside of the **enclosure** or on the side of a fire barrier opposite to the **PIS**.

The openings to which these properties apply are relative to the site or location of the **PIS** and of **combustible materials**. The locations of openings relative to the flame property are shown in Figure 41 and Figure 42.

Regardless of the equipment orientation, the flame orientation property of the **PIS** is always vertical, unless the equipment contains a forced airflow. Where the equipment has two or more **normal operating condition** orientations, opening properties apply to each possible orientation and airflow direction.

When the forced airflow across a **PIS** is moving due to air moving devices, the vertical orientation of the volume described in Figure 38 is rotated (tilted) around the **PIS** location from 0° (vertical orientation shown in Figure 38) to 45° in the direction of the forced airflow (see also Figure 39).

6.4.8.3.2 Fire barrier dimensions

A fire barrier shall have dimensions sufficient to prevent ignition of the edges of the barrier. The edges of the fire barriers shall extend to beyond the fire cone (see Figure 40).

6.4.8.3.3 Top openings and top opening properties

Top opening properties of a **fire enclosure** and a fire barrier shall apply to openings above a **PIS** as shown in Figure 41.

NOTE Any openings within the zone as shown in Figure 41 are regarded to be top openings, including side openings.

Top openings that fall within the volume defined in Figure 41 shall comply with the following test.

*The test is conducted using the needle-flame burner as specified in Clause S.2 placed vertically in a draft-free location. The distance between the inner side of the top openings and the centre of the burner tube is $7\text{ mm} \pm 1\text{ mm}$. The sample is placed in its normal operating position. The top openings are covered with a single layer of **cheesecloth**.*

*The flame is applied for a period of 1 min. The **cheesecloth** shall not ignite.*

In case of openings having different dimensions, the test shall be conducted on one opening of each group of the top openings with the same dimensions.

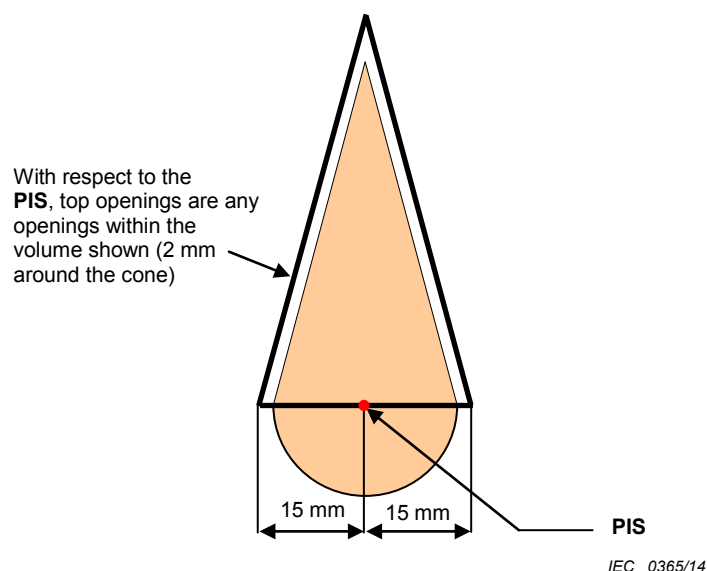

NOTE Dimensions of the cone are identical to Figure 37 and Figure 38.

Figure 41 – Top openings

No test is required provided that the openings do not exceed:

- 5 mm in any dimension, or
- 1 mm in width regardless of length.

6.4.8.3.4 Bottom openings and bottom opening properties

Bottom opening properties of a **fire enclosure** and a fire barrier shall apply to openings that are located in the volume as shown in Figure 42.

NOTE Any openings within the zone as shown in Figure 42 are regarded to be bottom openings, including side openings.

Bottom openings are those openings below a **PIS** and within 30 mm diameter cylinder extending indefinitely below the **PIS**.

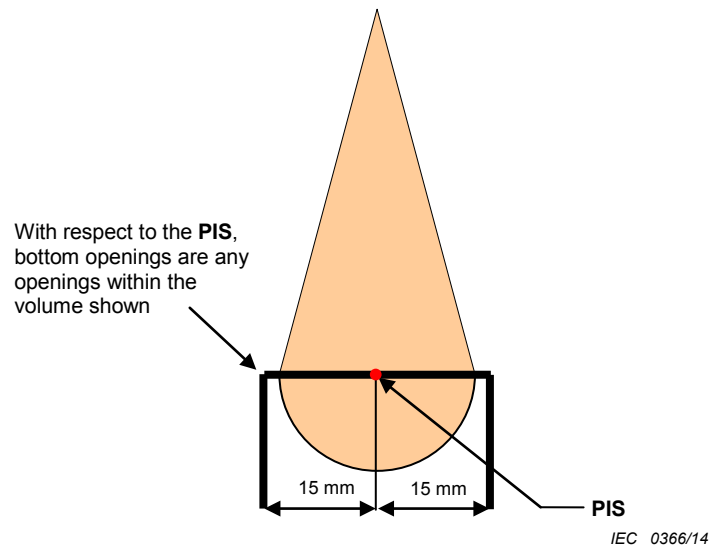

NOTE Dimensions of the cone are identical to Figure 37 and Figure 38.

Figure 42 – Bottom openings

Bottom openings shall comply with Clause S.3.

No test is necessary provided that one of the following conditions is met:

- a) the bottom openings do not exceed:
 - 3 mm in any dimension, or
 - 1 mm in width regardless of length;
- b) under components and parts meeting the requirements for **V-1 class material**, or **HF-1 class foamed material** or under components that pass the needle-flame test of IEC 60695-11-5 using a 30 s flame application, bottom openings shall not exceed:
 - 6 mm in any dimension, or
 - 2 mm in width regardless of length;
- c) the bottom openings do not exceed a 2 mm by 2 mm mesh of at least 0,45 mm diameter metal wire.
- d) the openings in the metal bottom **enclosure** comply with Table 34.

Table 34 – Size and spacing of holes in metal bottoms of fire enclosures

Metal bottom minimum thickness	Circular holes		Other shaped openings	
	Maximum diameter of holes	Minimum spacing of holes centre to centre	Maximum area	Minimum spacing of openings border to border
mm	mm	mm	mm ²	mm
0,66	1,1	1,7	1,1	0,56
0,66	1,2	2,4	1,2	1,1
0,76	1,1	1,7	1,1	0,55
0,76	1,2	2,4	1,2	1,1
0,81	1,9	3,2	2,9	1,1
0,89	1,9	3,2	2,9	1,2
0,91	1,6	2,8	2,1	1,1
0,91	2,0	3,2	3,1	1,2
1,0	1,6	2,8	2,1	1,1
1,0	2,0	3,0	3,2	1,0

Equipment intended only for use in fixed installations and intended to be floor standing on a non-combustible surface need not be provided with a **fire enclosure** bottom. Such equipment shall be marked in accordance with Clause F.5 in a clearly visible location with the following or equivalent wording:

RISK OF FIRE
Install only on concrete
or other non-combustible floor

6.4.8.3.5 Integrity of the fire enclosure

If part of a **fire enclosure** consists of a door or cover that can be opened by an **ordinary person**, the door or cover shall comply with requirements a), b), or c):

- a) the door or cover shall be interlocked and comply with the **safety interlock** requirements in Annex K;
- b) a door or cover, intended to be routinely opened by the **ordinary person**, shall comply with both of the following conditions:
 - it shall not be removable from other parts of the **fire enclosure** by the **ordinary person**; and
 - it shall be provided with a means to keep it closed during **normal operating conditions**;
- c) a door or cover intended only for occasional use by the **ordinary person**, such as for the installation of accessories, may be removable if an **instructional safeguard** is provided for correct removal and reinstallation of the door or cover.

6.4.8.3.6 Compliance criteria

Compliance is checked by inspection of applicable data sheets and, where necessary, by test.

6.4.8.4 Separation of a PIS from a fire enclosure and a fire barrier

A **fire enclosure** or fire barrier made of **combustible material** shall:

- have a minimum distance of 13 mm to an **arcng PIS**; and
- have a minimum distance of 5 mm to a **resistive PIS**.

Smaller distances are allowed provided that the part of the **fire enclosure** or fire barrier within the required separation distance complies with one of the following:

- the **fire enclosure** or fire barrier meets the needle-flame test according to IEC 60695-11-5. Severities are identified in Clause S.2. After the test, the **fire enclosure** or fire barrier material shall not have formed any holes that are bigger than allowed in 6.4.8.3.3 or 6.4.8.3.4 as appropriate; or
- the **fire enclosure** or fire barrier is made of **V-0 class material**.

6.5 Internal and external wiring

6.5.1 Requirements

In PS2 circuits or PS3 circuits, the insulation on internal or external wiring shall pass the test methods described below.

For conductors with a cross-sectional area of 0,5 mm² or greater, the test methods in IEC 60332-1-2 and IEC 60332-1-3 shall be used.

For conductors with a cross-sectional area of less than 0,5 mm², the test methods in IEC 60332-2-2 shall be used.

For both internal and external wiring, the test method described in IEC/TS 60695-11-21 may be used instead of the test methods in IEC 60332-1-2, IEC 60332-1-3 or IEC 60332-2-2.

6.5.2 Compliance criteria

The insulated conductor or cable shall be acceptable if it complies with the recommended performance requirements of the applicable IEC 60332 standards or with the requirements of IEC/TS 60695-11-21.

6.5.3 Requirements for interconnection to building wiring.

Equipment intended to provide power over the wiring system to remote equipment shall limit the output current to a value that does not cause damage to the wiring system, due to overheating, under any external load condition. The maximum continuous current from the equipment shall not exceed a current limit that is suitable for the minimum wire gauge specified in the equipment installation instructions.

NOTE This wiring is not usually controlled by the equipment installation instructions, since the wiring is often installed independent of the equipment installation.

PS2 circuits or PS3 circuits that provide power and that are intended to be compatible with LPS to **external circuits** (see Annex Q) shall have their output power limited to values that reduce the likelihood of ignition within building wiring or external devices located in a different room.

Compliance is checked with Clause Q.1.

Circuits providing power to devices or external components that are intended for use in the same room as the EUT are not subject to this requirement. See 6.6 for connection to secondary equipment.

External paired conductor cable circuits, such as those described in Table 14, ID numbers 1 and 2 having a minimum wire diameter of 0,4 mm, shall have the current limited to 1,3 A.

EXAMPLE Time/current characteristics of type gD and type gN fuses specified in IEC 60269-2 comply with the above limit. Type gD or type gN fuses rated 1 A, would meet the 1,3 A current limit.

Compliance is checked with Clause Q.1.2.

6.5.4 Compliance criteria

Compliance is checked by test, inspection and where necessary by the requirements of Annex Q.

6.6 Safeguards against fire due to the connection of additional equipment

Where it is unknown that the connected equipment or accessories (for example, a scanner, mouse, keyboard, DVD drive, CD-ROM drive or joystick) are likely to comply with this standard, the delivered power shall be limited to PS2 or shall comply with Clause Q.1.

Compliance is checked by inspection or measurement.

7 Injury caused by hazardous substances

7.1 General

To reduce the likelihood of injury due to exposure to **hazardous substances**, equipment shall be provided with the **safeguards** specified in Clause 7.

NOTE These **safeguards** are not intended to be the only means to reduce the likelihood of such injury.

7.2 Reduction of exposure to hazardous substances

The exposure to **hazardous substances** shall be reduced. Reduction of exposure to **hazardous substances** shall be controlled by using containment of the **hazardous substances**. Containers shall be sufficiently robust and shall not be damaged or degraded by the contents over the lifetime of the product.

Compliance is checked by:

- *the examination of the effects the chemical has on the material of the container; and*
- *any relevant tests of Annex T according to 4.4.4, following which there shall be no leakage from the container.*

7.3 Ozone exposure

For equipment that produces ozone, the installation and operating instructions shall indicate that precaution shall be taken to ensure that the concentration of ozone is limited to a safe value.

NOTE 1 Currently, the typical long term exposure limit for ozone is considered to be $0,1 \times 10^{-6}$ (0,2 mg/m³) calculated as an 8 h time-weighted average concentration. Time-weighted average is the average level of exposure over a given time period.

NOTE 2 Ozone is heavier than air.

Compliance is checked by inspection of instructions or accompanying documents.

7.4 Use of personal safeguards (PPE)

Where **safeguards**, such as containment of a chemical, are not practical, a **personal safeguard** and its use shall be specified in the instructions that are provided with the equipment.

Compliance is checked by inspection of instructions or accompanying documents.

7.5 Use of instructional safeguards and instructions

Where a **hazardous substance** is capable of causing an injury, **instructional safeguards** as specified in ISO 7010 and instructions shall be applied to the equipment in accordance with Clause F.5.

Compliance is checked by inspection of instructions or accompanying documents.

7.6 Batteries and their protection circuits

Batteries and their protection circuits shall comply with Annex M.

8 Mechanically-caused injury

8.1 General

To reduce the likelihood of injury due to exposure to mechanical hazards, equipment shall be provided with the **safeguards** specified in Clause 8.

NOTE 1 In some cases, the person is the source of the kinetic energy.

NOTE 2 Where not specifically mentioned in Clause 8, the words “products” and “equipment” also cover carts, stands and carriers used with these products or equipment.

8.2 Mechanical energy source classifications

8.2.1 General classification

Various categories of mechanical energy sources are given in Table 35.

Table 35 – Classification for various categories of mechanical energy sources

Line	Category	MS1	MS2	MS3
1	Sharp edges and corners	Does not cause pain or injury ^b	Does not cause injury ^b but may be painful	May cause injury ^c
2	Moving parts	Does not cause pain or injury ^b	Does not cause injury ^b but may be painful	May cause injury ^c
3a	Plastic fan blades ^a See Figure 44	$\frac{N}{15\,000} + \frac{K}{2\,400} \leq 1$	> MS1; and $\frac{N}{44\,000} + \frac{K}{7\,200} \leq 1$	> MS2
3b	Other fan blades ^a See Figure 43	$\frac{N}{15\,000} + \frac{K}{2\,400} \leq 1$	> MS1; and $\frac{N}{22\,000} + \frac{K}{3\,600} \leq 1$	> MS2
4	Loosening, exploding or imploding parts	NA	NA	See ^d
5	Equipment mass	≤ 7 kg	7 kg < mass ≤ 25 kg	> 25 kg
6	Wall/ceiling mount	Equipment mass ≤ 1 kg mounted ≤ 2 m ^e	Equipment mass > 1 kg mounted ≤ 2 m ^e	All equipment mounted > 2 m

^a The K factor is determined from the formula $K = 6 \times 10^{-7} (m r^2 N^2)$ where m is the mass (kg) of the moving part of the fan assembly (blade, shaft and rotor), r is the radius (mm) of the fan blade from centre line of the motor (shaft) to the tip of the outer area likely to be contacted, N is the rotational speed (rpm) of the fan blade.

In the end product, the fan maximum operational voltage can be different than the **rated voltage** of the fan and this difference should be taken into account.

^b The phrase “Does not cause injury” means that a doctor or hospital emergency attention is not needed.

- c The phrase “May cause injury” means that a doctor or hospital emergency attention may be needed.
- d The following equipment constructions are examples considered MS3:
 - CRTs having a maximum face dimension exceeding 160 mm; and
 - lamps in which the pressure exceeds 0,2 MPa when cold or 0,4 MPa when operating.
- e This classification can only be used if the manufacturer’s instructions state that the equipment is only suitable for mounting at heights ≤ 2 m.

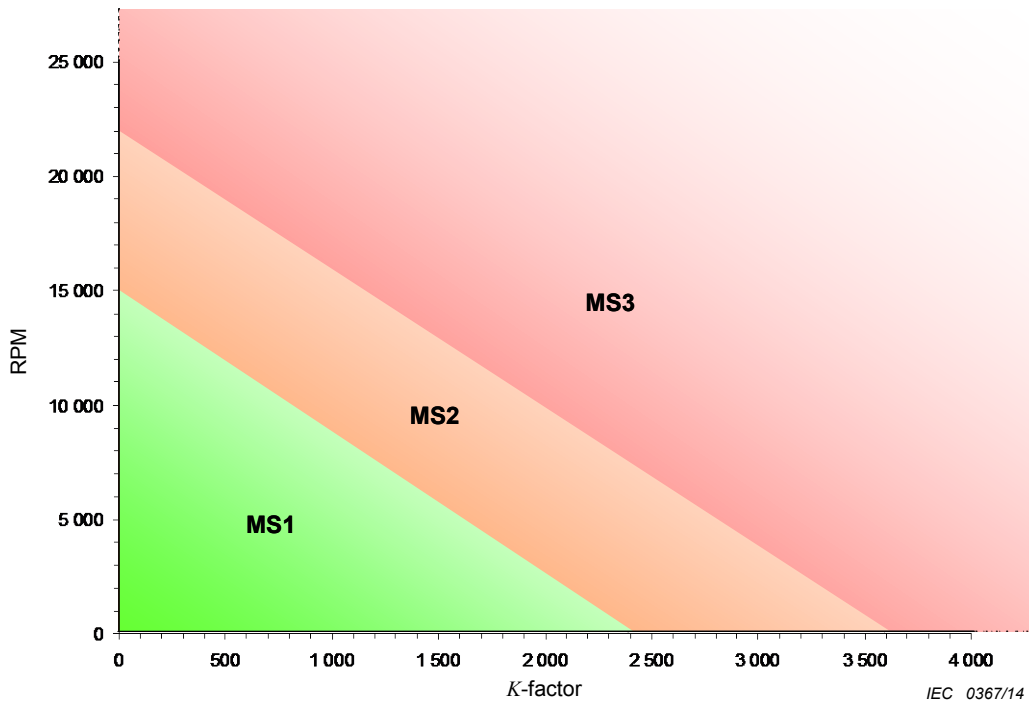

Figure 43 – Limits for moving fan blades made of non-plastic materials

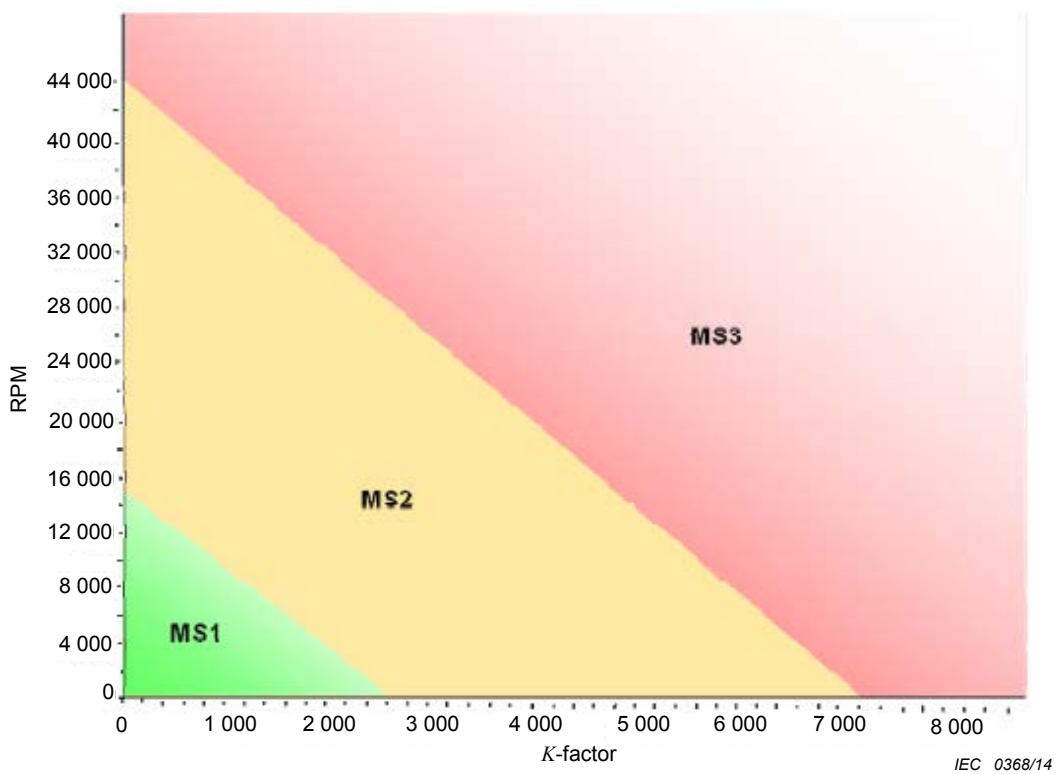

Figure 44 – Limits for moving fan blades made of plastic materials

8.2.2 MS1

MS1 is a class 1 mechanical energy source with levels not exceeding MS1 limits under **normal operating conditions** and **abnormal operating conditions** and not exceeding MS2 under **single fault conditions**.

8.2.3 MS2

MS2 is a class 2 mechanical energy source with levels not exceeding MS2 limits under **normal operating conditions**, **abnormal operating conditions**, and **single fault conditions**, but is not MS1.

8.2.4 MS3

MS3 is a class 3 mechanical energy source with levels exceeding MS2 limits under **normal operating conditions**, **abnormal operating conditions** or **single fault conditions**, or any mechanical energy source declared to be treated as MS3 by the manufacturer.

8.3 Safeguards against mechanical energy sources

Except as given below, **safeguard** requirements for parts **accessible** to **ordinary persons**, **instructed persons** and **skilled persons** are given in 4.3.

An **instructional safeguard** shall be provided for MS2 that is not obvious to an **instructed person** or for MS3 that is not obvious to a **skilled person**.

Other MS3 parts not actively being serviced shall be located or guarded so that unintentional contact with such parts during service operations is an unlikely result in the **skilled person** involuntary recoiling from class 2 or class 3 energy sources being serviced.

8.4 Safeguards against parts with sharp edges and corners

8.4.1 Requirements

Safeguards that reduce the likelihood of injury by parts with sharp edges and corners in **accessible** areas of the equipment are specified below.

Classification of the energy sources shall be done according to Table 35, line 1.

Where a sharp edge or corner is required to be **accessible** for the function of the equipment:

- any potential exposure shall not be life threatening; and
- the sharp edge or corner shall be obvious to an **ordinary person** or an **instructed person** when exposed; and
- the sharp edge shall be guarded as much as practicable; and
- an **instructional safeguard** shall be provided to reduce the risk of unintentional contact in accordance with Clause F.5, except that element 3 is optional.

The elements of the **instructional safeguard** shall be as follows:

- element 1a: , IEC 60417-6043 (2011-01)
- element 2: “Sharp edges” or equivalent text
- element 3: optional
- element 4: “Do not touch” or equivalent text

8.4.2 Compliance criteria

Where a sharp edge or corner is required to be **accessible** for the function of the equipment, compliance is checked by inspection.

Where a sharp edge or corner is not required to be **accessible** for the function of the equipment compliance is checked by the relevant tests of Annex V. During and after the application of the force, the sharp edge or corner shall not be **accessible**.

8.5 Safeguards against moving parts

8.5.1 Requirements

Safeguards that reduce the likelihood of injury caused by moving parts of the equipment (for example, pinch points, meshing gears and parts that may start moving due to unexpected resetting of a control device) are specified below.

Plastic fan blades are classified according to Table 35, line 3a. Other fan blades are classified according to Table 35, line 3b. Other moving parts are classified according to Table 35, line 2.

NOTE 1 The ability of a part to cause injury is not solely dependent upon the kinetic energy it possesses. Consequently, the classification used in this standard can only be based on typical experience and engineering judgement.

NOTE 2 Examples of factors influencing the energy transfer to a body part include shape of the surface that strikes the body part, elasticity, velocity and the mass of equipment and body part.

If a **safety interlock** is used as **safeguard**, it shall comply with Annex K. The movement of the part shall be reduced to MS1 before the part is **accessible**.

Unless otherwise specified, where the likelihood exists that fingers, jewellery, clothing, hair, etc., can come into contact with moving MS2 or MS3 parts, an **equipment safeguard** shall be provided to prevent entry of body parts or entanglement of such items.

If a moving MS2 part is required to be **accessible** for the function of the equipment to an **ordinary person** or a moving MS3 part to an **ordinary person** or an **instructed person**:

- any exposure shall not be life threatening; and
- the moving part shall be obvious when exposed; and
- the moving part shall be guarded as much as practicable; and
- an **instructional safeguard** as given in 8.5.2 shall be used; and
- for MS3, a manually activated stopping device shall be clearly visible and placed in a prominent position within 750 mm of the MS3 part.

Moving MS3 parts:



- that are only **accessible** to a **skilled person**; and
- where the MS3 moving part is not obvious (for example, a device having intermittent movement),

shall have an **instructional safeguard** as given in 8.5.2. Unless the moving part is arranged, located, enclosed or guarded in such a way that the possibility of contact with the moving parts is unlikely, a stopping device shall be placed in a clearly visible and prominent position within 750 mm of the MS3 part.

8.5.2 Instructional safeguard requirements

An **instructional safeguard** shall be provided to reduce the likelihood of unintentional contact with a moving part in accordance with Clause F.5, except that element 3 is optional.

The elements of the **instructional safeguard** shall be as follows:

- element 1a:  IEC 60417-6056 (2011-05) for moving fan blades or
-  IEC 60417-6057 (2011-05) for other moving parts
- element 2: “Moving parts” or “Moving fan blade” as applicable, or equivalent text
- element 3: optional
- element 4: “Keep body parts away from moving parts” or “Keep body parts away from fan blades” or “Keep body parts out of the motion path” as applicable, or equivalent text

During **ordinary person** servicing conditions, where it is necessary to defeat or bypass the **equipment safeguard** preventing access to a moving part classified as MS2, an **instructional safeguard** shall be provided to:

- disconnect the power source prior to defeating or bypassing the **equipment safeguard**; and
- restore the **equipment safeguard** before restoring power.

8.5.3 Compliance criteria

The accessibility of moving parts shall be checked by inspection and, if necessary, be evaluated according to the relevant parts of Annex V.

8.5.4 Special categories of equipment comprising moving parts

8.5.4.1 Large data storage equipment

The requirements of IEC 60950-23 are additional to the relevant requirements in this standard.

Large equipment is typically of such a size that a person may enter completely. Systems may also include similar equipment having areas containing moving parts into which only a complete limb or head may enter. These requirements apply to a three dimensional envelope of 0,75 m³ or more within reach of the moving part.

The following references in IEC 60950-23 shall be treated as follows:

- replace IEC 60950-1:2005, 2.8 by Annex K;
- replace IEC 60950-1:2005, 2.8.6 by Clause K.4;
- replace "SERVICE PERSON" by "**skilled person**";
- replace "OPERATOR ACCESS AREA" by "areas **accessible** by an **ordinary person** as determined by Annex V".

NOTE An example of these systems is a self-contained data storage system.

8.5.4.2 Equipment having an electromechanical device for destruction of media

8.5.4.2.1 General requirements

Equipment safeguards to protect persons, including children, for equipment intended to mechanically destroy various media by means of moving parts that draw the media into the equipment are specified below. The media destruction device within this equipment is classed as MS3.

NOTE 1 Examples of this type of equipment include household use and home-office use document shredding and similar media destruction devices, as determined by the nature of their power source.

For equipment for use in locations where children are not likely to be present, see Clause F.4.

NOTE 2 This equipment design typically applies to commercial or industrial equipment expected to be installed in locations where only adults are normally present.

Equipment shall be provided with **safeguards** so that MS3 moving parts are not **accessible** to the appropriate jointed test probe of Annex V and the wedge probe of Figure V.4. Requirements for **safety interlocks** are according to Annex K, except that where a moving part cannot be reduced to the appropriate energy class within 2 s, the **safety interlock** shall continue to prevent access.

8.5.4.2.2 Instructional safeguards against moving parts

For equipment installed where children may be present, an **instructional safeguard** shall be provided in accordance with Clause F.5, except that element 3 is optional.

The elements of the **instructional safeguard** shall be as follows:

- element 1a: , IEC 60417-6057 (2011-05)
- element 2: optional
- element 3: optional
- element 4: “This equipment is not intended for use by children” and “Avoid touching the media feed opening with the hands, clothing or hair” and “Unplug this equipment when not in use for an extended period of time” or equivalent text

8.5.4.2.3 Disconnection from the supply

An isolating switch complying with Annex L shall be provided to disconnect power to MS3 moving parts. A switch with an "OFF" position, that removes all power from the MS3 moving part is acceptable. The switch shall be located where it is easily **accessible** to the user whose body part or clothes may be caught.

The "ON" and "OFF" positions of a two-position switch shall be marked in accordance with F.3.5.2.

For a multi-position switch, the "OFF" position of the switch shall be marked in accordance with F.3.5.2, and the other positions shall be marked with appropriate words or symbols.

8.5.4.2.4 Test method

The media destruction device is tested with the wedge probe of Figure V.4 applied in any direction relative to the opening:

- *with a force up to 45 N for a strip-cut type device; and*
- *with a force up to 90 N for a cross-cut type device.*

NOTE Media destruction devices are typically identified as either strip-cut type or cross-cut type. A strip-cut media destruction device shreds the media into long strips using a motor-based shredding mechanism. A cross-cut media destruction device shreds the media two or more ways into tiny particles, typically using a more powerful motor and more complex shredding mechanism.

*Any **enclosure** or guard that can be removed or opened by an **ordinary person** or an **instructed person** shall be removed or opened prior to application of the probes.*

8.5.4.2.5 Compliance criteria

Compliance is checked in accordance with V.1.2 and V.1.5. The wedge probe shall not contact any moving part.

*Where the equipment is provided with a **safety interlock**, compliance is checked according to Annex K, except where a moving part cannot be reduced to the appropriate energy class within 2 s, the **safety interlock** shall continue to prevent access.*

8.5.5 High pressure lamps

8.5.5.1 General

The containment mechanism for high pressure lamps that are considered MS3 according to Line 4 of Table 35 shall have adequate strength to contain an **explosion** of the lamp so as to reduce the likelihood of injury to an **ordinary person** or **instructed person** during normal use, or lamp assembly replacement, as appropriate.

8.5.5.2 Test method

For the protection against the effects of a high pressure lamp failure, the following test is performed as follows:

- lamp assemblies considered MS3 parts during field replacement are tested separate from the equipment;*
- lamp assemblies only considered MS3 parts during operation, may be tested separately, or as normally installed in the equipment, or both.*

*An **explosion** of the lamp is stimulated by mechanical impact, electronic pulse generator or similar method. The lamp shall operate for at least 5 min to obtain operational temperature and pressure. To evaluate the rupture results for potential debris area and particle size, a dark sticky mat (or another adequate method) of adequate size is placed near the exhaust vent of the equipment. The equipment opening shall be oriented to maximize potential for particles to be expelled from the product horizontally across the dark sticky mat. After the rupture, the glass particles generated are measured using a magnified glass piece with a 0,1 mm resolution. The test shall be conducted to simulate the worst case operating position specified in the instructions.*

NOTE It is easier for the inspection of potential glass debris if the sticky mat has a dark blue colour.

An example of an electronic pulse generator method is given in Figure D.3.

The charge is increased in steps of 5 J until the lamp ruptures are repeatable.

8.5.5.3 Compliance criteria

Compliance is checked by physical inspection or, if necessary, by the tests of 8.5.5.2.

When tested in accordance with 8.5.5.2, inspect the dark sticky mat for glass particles, and:

- glass particles less than 0,8 mm in the longest axis shall not be found beyond 1 m of the **enclosure** opening; and*
- glass particles equal to or greater than 0,8 mm in the longest axis shall not be found.*

*For professional equipment, where it is unlikely that the particles will be within reach of an **ordinary person**, the value of 0,8 mm may be replaced with 5 mm.*

8.6 Stability of equipment

8.6.1 Requirements

Classification of products for the purposes of assessing equipment stability is to be done according to Table 35, line 5.

In case units are fixed together, the MS class is determined by the total weight of the units. If units are intended to be separated for relocation, the MS class is determined by the individual weight.

Individual units that are designed to be mechanically fixed together on site and are not used individually, or **stationary equipment**, shall be assessed by inspection after installation according to the manufacturer’s instructions and, if necessary, tested according to 8.6.2.2.

Equipment shall comply with the requirements and tests given in 8.6.2, 8.6.3, 8.6.4 and 8.6.5 according to Table 36. Where an “x” is given, it means that the test is applicable.

Table 36 – Overview of requirements and tests

Equipment type		Type of test				
		Static stability 8.6.2.2	Downward force 8.6.2.3	Relocation 8.6.3	Glass slide 8.6.4	Horizontal force 8.6.5
MS1	All equipment	No stability requirements				
MS2	Floor standing			x		
	Non-floor standing	x				
	Controls or display ^a				x	x
	Fixed ^b	No stability requirements				
MS3	Floor standing	x	x	x		
	Non-floor standing	x				
	Controls or display ^a	x			x	x
	Fixed ^b	No stability requirements				
^a Equipment with front mounted accessible user controls and equipment having displays with moving images likely to be used in the home or similar installation environments where the equipment may be accessible to children. ^b Where equipment is expected to be installed by an ordinary person , equipment having a screw hole or other means to secure the equipment, such as for securement to a table or for earth quake protection, is not considered to be fixed. Such securements are considered to be supplementary safeguards .						

Where thermoplastic materials are involved in the construction, the relevant stability tests shall be conducted after the stress relief test in Clause T.8 when the equipment has cooled to room temperature.

MS2 and MS3 television sets shall have an **instructional safeguard** in accordance with Clause F.5, except that the **instructional safeguard** may be included in the installation instructions or equivalent document accompanying the equipment.

The elements of the **instructional safeguard** shall be as follows:

- element 1a: not available
- element 2: “Stability Hazard” or equivalent word
- element 3: “The television set may fall, causing serious personal injury or death” or equivalent text
- element 4: the text below or equivalent text

Never place a television set in an unstable location. A television set may fall, causing serious personal injury or death. Many injuries, particularly to children, can be avoided by taking simple precautions such as:

- Using cabinets or stands recommended by the manufacturer of the television set.
- Only using furniture that can safely support the television set.
- Ensuring the television set is not overhanging the edge of the supporting furniture.
- Not placing the television set on tall furniture (for example, cupboards or bookcases) without anchoring both the furniture and the television set to a suitable support.
- Not placing the television set on cloth or other materials that may be located between the television set and supporting furniture.
- Educating children about the dangers of climbing on furniture to reach the television set or its controls.

If the existing television set is going to be retained and relocated, the same considerations as above should be applied.

8.6.2 Static stability

8.6.2.1 Test setup

The equipment shall be blocked, if necessary, by means of a stop of the smallest dimensions possible to keep it from sliding or rolling during the test. During the tests, containers, if any, are to contain the amount of substance within their rated capacity that will result in the most disadvantageous condition.

*All doors, drawers, casters, adjustable feet and other appurtenances, if used by an **ordinary person**, are arranged in any combination that results in the least stability. Equipment provided with multi-positional features shall be tested in the least favourable position based on the equipment construction. However, if the casters are intended only to transport the unit, and if the installation instructions require adjustable feet to be lowered after installation, then the adjustable feet (and not the casters) are used in this test.*

*Where equipment is subject to periodic maintenance or routinely serviced or repaired at its intended use location, the doors, drawers, etc. or any other adjustment means **accessible** to an **instructed person** or **skilled person** shall be arranged in any combination specified by the servicing instructions that results in the least stability.*

The tests of 8.6.2.2 and 8.6.2.3 shall be performed as indicated in Table 36.

8.6.2.2 Static stability test

Equipment shall not tip over when a force equal to 20 % of the weight of the unit, but not more than 250 N, is applied in any direction, except upwards, to any point on the equipment in such a way as to produce the maximum overturning moment. The test may be applied at any height not exceeding 1,5 m from the base of the equipment. The test force shall be discontinued if the equipment remains stable after being tilted 10° from vertical. Alternatively, the equipment shall be tipped at any angle from the vertical up to and including 10°.

8.6.2.3 Downward force test

Equipment shall not tip over when a constant downward force of 800 N is applied at the point of leverage for a maximum moment to any point of any surface within 10° of horizontal of at least 125 mm by at least 200 mm, at any height up to 1 m from the base of the equipment. The 800 N force is applied by means of a suitable test apparatus having a flat surface of approximately 125 mm by 200 mm. The downward force is applied with the complete flat

surface of the test apparatus in contact with the equipment, however the test apparatus need not be in full contact with uneven surfaces (for example, corrugated or curved surfaces).

Equipment having a shape or a flexibility of the surface that is not likely to be used as a step or a ladder are exempt from the test.

NOTE Examples are products in combination with a cart or stand or products with protrusion or recess where the construction is obviously not to be used as a step or ladder.

8.6.2.4 Compliance criteria

During the tests, the equipment shall not tip over.

8.6.3 Relocation stability test

8.6.3.1 Requirements

Equipment shall be stable when it is being relocated.

Compliance is checked by the test of 8.6.3.2. The equipment shall not tip over during the test. Equipment with wheels having a minimum diameter of 100 mm is considered to comply with the above requirements without test.

8.6.3.2 Test method

The equipment is tilted to an angle of 10° from its normal upright position in any direction. If the equipment is such that when it is tilted through an angle of 10° when standing on a horizontal plane, a part of the equipment not normally in contact with the supporting surface would touch the horizontal plane, the equipment is placed on the edge of the horizontal support during the test so that the contact is not made. Alternatively, the equipment may be placed on a plane and is rotated through an angle of 360° about its normal vertical axis while tilted at 10°.

*Equipment expected to be moved or relocated by **ordinary persons** shall have*

- all doors and drawers not having a positive means of retention and that can be opened inadvertently, and*
- casters, adjustable feet and the like*

arranged in any combination that results in the least stability.

*Equipment expected to be moved or relocated by an **instructed person** or a **skilled person**, shall have all doors, drawers, etc., positioned in accordance with the manufacturer's instructions.*

A unit provided with multi-positional features shall be tested in the least favourable position based on the equipment construction.

8.6.4 Glass slide test

8.6.4.1 Requirements

Equipment shall be so constructed that it will not slide or tip over on a supporting surface made of glass.

8.6.4.2 Test method and compliance criteria

The equipment is placed on a clean, dry, glass covered horizontal surface so that only the supporting feet are in contact with the glass. The glass-covered surface is then tilted in the most unfavourable direction through an angle of 10°.

During the test, the equipment shall not slide or tip over.

8.6.5 Horizontal force test and compliance criteria

The equipment is to be placed on a horizontal non-skid surface with all doors, drawers, casters, adjustable feet and other movable parts arranged in any combination that results in the least stable condition. The equipment shall be blocked, if necessary, by means of a stop of the smallest dimensions possible, to keep it from sliding or rolling when subjected to one of the following tests:

- *an external horizontal force of 13 % of the weight of the equipment or 100 N, whichever is less, is applied to that point on the equipment that will result in the least stability. The force shall not be applied more than 1,5 m above the supporting surface; or*
- *the equipment shall be moved through any angle of tilt up to and including 15° from the vertical; or*
- *the equipment is placed on a plane and is rotated through an angle of 360° about its normal vertical axis while tilted at an angle of 15°.*

During the test, the equipment shall not tip over.

8.7 Equipment mounted to a wall or ceiling

8.7.1 Requirements

Classification of equipment for the purposes of assessing wall mounting means is done according to Table 35, line 6.

For MS2 or MS3 equipment:

- If the manufacturer specifies a specific wall or ceiling mount, the combination of the mount and the equipment shall comply with 8.7.2, Test 1. The hardware used to fix the mounting means to the equipment shall either be provided with the equipment, or described in detail in the user instructions (for example, length of screws, diameter of the screws, etc.).
- If the manufacturer does not specify a specific wall or ceiling mount, but the equipment is provided with any part (for example, a hook or threaded hole) which facilitates attaching such a mount to the equipment, such parts shall comply with 8.7.2, Test 2, as appropriate. The user instruction shall advise on the safe use of such parts (for example, screw size including thread size and length, number of screws, etc.).
- If the equipment is provided with threaded parts for attachment of the mounting means, the threaded parts without the mounting means shall additionally comply with 8.7.2, Test 3.

NOTE The tests are meant to test the fixing of the mounting means to the equipment and not to test the fixing to the wall or ceiling.

8.7.2 Test methods

If the construction involves polymeric materials, the tests shall be performed after the stress relief test of Clause T.8.

Test 1

The equipment is mounted in accordance with the manufacturer's instructions and the mounting means positioned, when possible, to represent the most severe stress on the supports.

A force in addition to the weight of the equipment is applied downwards through the centre of gravity of the equipment, for 1 min. The additional force shall be:

- three times the weight of the equipment; or
- the weight of the equipment plus 880 N,

whichever is less.

In addition, for wall mounted equipment, a horizontal force of 50 N is applied laterally for 60 s.

Test 2

The test force shall be equivalent to the least of the following divided by the number of attachment points in the mounting system:

- four times the weight of the equipment; or
- two times the weight of the equipment plus 880 N.

Each point in the mounting system shall be subjected to a shear force perpendicular to its centre axis for 1 min. The force shall be applied in four directions, one direction at a time, separated by 90°.

Each point in the mounting system, one at a time, shall be subjected to an inward directed push force parallel to its centre axis for 1 min.

Each point in the mounting system, one at a time, shall be subjected to an outward directed pull force parallel to its centre axis for 1 min.

Test 3

If the mounting system design relies upon threaded parts, a torque according to Table 37 shall be applied to each threaded part, one at a time. If a corresponding screw fastener is supplied by the manufacturer, it shall be used for the test. If no corresponding screw fastener is supplied by the manufacturer, even though a screw type may be recommended in the user instructions, any screw with the same diameter shall be used for the test.

Table 37 – Torque to be applied to screws

Nominal diameter of screw mm	Torque Nm
up to and including 2,8	0,4
over 2,8 up to and including 3,0	0,5
over 3,0 up to and including 3,2	0,6
over 3,2 up to and including 3,6	0,8
over 3,6 up to and including 4,1	1,2
over 4,1 up to and including 4,7	1,8
over 4,7 up to and including 5,3	2,0
over 5,3 up to and including 6,0	2,5

8.7.3 Compliance criteria

Compliance is checked by inspection and by the tests of 8.7.2, as applicable. The equipment or its associated mounting means shall not become dislodged and shall remain mechanically intact and secure during the test.

8.8 Handle strength

8.8.1 General

A handle that is declared by the manufacturer for the purpose of lifting or carrying the equipment shall comply with the tests as specified in 8.8.2.

The equipment is classified according to Table 35, line 5.

If equipment having handles is designed, or provided with instructions, for lifting or carrying multiple units together, the class is determined taking into account the weight that may be carried.

8.8.2 Test method and compliance criteria

The equipment shall pass the following test:

A weight shall be uniformly applied over a 75 mm width at the centre of the handle, without clamping.

The weight shall be the equipment weight plus an additional weight as specified below:

- *for MS1 equipment with two or more handles, a weight that exerts a force of three times the weight of the equipment;*

NOTE No tests apply to MS1 equipment having only one handle.

- *for MS2 equipment, a weight that exerts a force of three times the weight of the equipment;*
- *for MS3 equipment with a mass 50 kg or less, a weight that exerts a force of two times the weight of the equipment or 75 kg, whichever is greater;*
- *for MS3 equipment with a mass greater than 50 kg, a weight that exerts a force of the weight of the equipment or 100 kg, whichever is greater.*

The additional weight shall be started at zero and gradually increased so that the test value is attained in 5 s to 10 s and maintained for 60 s. When more than one handle is provided, the force shall be distributed between the handles. The distribution of the forces shall be determined by measuring the percentage of the equipment's weight sustained by each handle with the equipment in the intended carrying position. When MS2 equipment is furnished with more than one handle, and it can be considered capable of being carried by only one handle, each handle shall be capable of sustaining the total force.

As a result of the test, the handle, its securing means, or that portion of the enclosure to which it is secured, shall not break, crack, or detach from the equipment.

8.9 Wheels or casters attachment requirements

8.9.1 General

The likelihood of MS3 and some MS2 equipment, including carts, stands and similar carriers that support the equipment, from tipping over during movement shall be reduced. The equipment is classified according to Table 35, line 5.

8.9.2 Test method

*Wheels or casters on MS3 equipment, or their supporting cart, stand or similar carrier, intended to be moved as part of its **normal operating conditions**, shall be capable of withstanding a pull of 20 N. The pull force is to be applied by a weight, or a steady pull, to the wheel or caster for a period of 1 min in any direction made possible by the construction.*

During the test, the wheels or casters shall not be damaged or pull free from its securing means.

8.10 Carts, stands, and similar carriers

8.10.1 General

The equipment shall be stable with the cart, stand or similar carrier. The classifications of Table 35, line 5 are applied using the combined mass of both the equipment and the carts or stands specified with the equipment.

All carts and stands specified for use with the equipment shall be subjected to the applicable tests described in the following subclauses. A cart, stand or carrier shall be subjected to the applicable tests alone and again with the equipment specified by the manufacturer placed on the cart or stand.

MS3 equipment, including their supporting carts, stands and similar carriers that support the equipment, that are not moved as part of its **normal operating conditions**, shall comply with the horizontal force test of 8.6.5.

MS2 or MS3 equipment more than 1 m in height, including equipment mounted on their specified cart, stand or carrier, shall comply with the relocation stability test in 8.6.3 except that the tip angle becomes 15°. If equipment is provided with wheels or casters that allow the equipment to only move in limited directions, the test is only applied in those directions (for example, an electronic white board).

8.10.2 Marking and instructions

A cart, stand or similar carrier that is specified by the manufacturer for use with specific equipment, but is packaged and marketed separately from the equipment, shall be provided with an **instructional safeguard** in accordance with Clause F.5.

The elements of the **instructional safeguard** shall be as follows:

- element 1a: not available
- element 2: “Caution” or equivalent text
- element 4: “This (cart, stand, or carrier) is intended for use only with (manufacturer's name), (model number or series), (equipment name).” or equivalent text
- element 3: “Use with other equipment may result in instability causing injury” or equivalent text

The elements shall be in the order 2, 4, and 3.

The **instructional safeguard** shall be affixed to the cart, stand or carrier, or included in the installation instructions or equivalent document accompanying the equipment.

Equipment only intended and shipped for use with a specific cart, stand or similar carrier, shall be provided with an **instructional safeguard** in accordance with Clause F.5 and be comprised of:

- element 1a: not available

- element 2: “Caution” or equivalent word or text
- element 4: “This (equipment name) is for use only with (manufacturer's name), (model number or series), (cart, stand, or carrier)” or equivalent text
- element 3: “Use with other (carts, stands, or carriers) may result in instability causing injury” or equivalent text

The elements shall be in the order 2, 4, and 3.

The **instructional safeguard** shall be affixed to the equipment or included in the installation instructions or equivalent document accompanying the equipment.

8.10.3 Cart, stand or carrier loading test and compliance criteria

*A cart, stand or carrier shall be constructed so that permanent deformation or damage that is capable of resulting in injury to a person, does not occur when it is subjected to a force of 220 N applied for 1 min to any grippable or leverage point **accessible** to a child.*

To determine compliance, the force is applied through the end of a 30 mm diameter circular cylinder. The force is to be applied to a shelf drawer, dowel rung support, or equivalent part that is within 750 mm from the floor and will support some or all of a child's weight. The force is to be applied for 1 min with the cart or stand at room temperature. The part shall not collapse or break so as to expose sharp edges or produce pinch points that are capable of resulting in injury.

In addition, a cart, stand or other carrier shall be constructed so that permanent deformation or damage that is capable of resulting in injury to persons does not occur when each supporting surface is individually loaded with:

- *the manufacturer's intended load plus 440 N for the surface intended to support a display with moving images; or*
- *four times the manufacturer's intended load or 100 N, whichever is greater but not to exceed 440 N, is applied to all applicable surfaces.*

A dedicated storage area intended to accommodate specific accessories such as media tapes, discs, etc. shall be fully loaded to the rated load.

The weight is to be applied for 1 min on each supporting surface, with the other supporting surfaces unloaded.

8.10.4 Cart, stand or carrier impact test

When tested as described below, a cart, stand or carrier shall not produce a risk of injury to persons.

A single 7 J impact is to be applied to any part of the cart or stand and the test method is to be as described in Clause T.6. However, a cart, stand or carrier made of glass shall be tested instead according to 4.4.4.6.

8.10.5 Mechanical stability

A cart, stand or carrier, including floor standing types, shall be subjected to the applicable tests described in 8.6.3 and 8.6.5 by itself, and where applicable in combination with its intended MS2 or MS3 equipment .

For the purposes of these tests, the weight shall be considered as the total weight of the equipment plus the weight of the cart, stand or carrier. The equipment shall be installed according to the manufacturer's instructions and the horizontal force shall be applied to either

the cart, stand or carrier or intended equipment to produce a maximum overturning moment on the equipment at a point up to a maximum height of 1,5 m above the floor level.

If during the tests of 8.6.3 and 8.6.5 the equipment starts to slide or tip relative to the cart, stand or carrier, only the horizontal force test shall be repeated by reducing the force to 13 % of the weight of the equipment alone, or 100 N, whichever is less.

The equipment and cart or stand shall not tip over.

8.10.6 Thermoplastic temperature stability

An equipment, cart, stand or carrier using thermoplastic materials in its construction shall withstand the test of Clause T.8, without any shrinkage, warpage, or other distortion of the thermoplastic materials that results in the equipment failing to comply with 8.10.3, 8.10.4 and 8.10.5.

8.11 Mounting means for rack mounted equipment

8.11.1 General

This subclause specifies requirements for the slide-rail to reduce the likelihood of injury by retaining the slide-rail mounted equipment (SRME) in a stable position and not allowing the slide-rails to buckle, means of attachment to break, or the SRME to slide past the end of the slide-rails.

The requirements below apply to the mounting means of MS2 and MS3 SRME that is:

- installed in a rack and that is intended to be extended on slide-rails away from the rack for installation, use or service; and
- SRME that extends the full width of the rack; and
- having a top installation position more than 1 m in height from the supporting surface.

The requirements do not apply to:

- equipment subassemblies; or
- other equipment fixed in place in the rack; or
- equipment that is not intended to be serviced while extended on slide-rails.

The mechanical mounting means for the SRME are referred to as slide-rails. The SRME may be the actual product configured in its worst case mechanical loading, or a representative **enclosure** with weights to simulate worst case loading.

NOTE 1 Slide-rails include bearing slides, friction slides or other equivalent mounting means.

NOTE 2 Subassemblies of the end product (for example, removable modules, component drawers, pull out paper/heater trays in copiers/printers) are not considered to be SRME.

8.11.2 Requirements

Classification of products for the purposes of assessing equipment stability is to be done according to Table 35, line 5.

NOTE For assessing equipment stability, see 8.6.

Slide-rails shall retain the SRME and have end stops that prevent the SRME from unintentionally sliding off the mounting means.

The slide-rails shall be installed in a representative rack with the SRME, or in an equivalent setup in accordance with the manufacturer's instructions.

Slide-rails and their mounting means shall meet the mechanical strength tests of 8.11.3 and 8.11.4. Following each test, the slide-rails and the SRME may be replaced before conducting the next test.

8.11.3 Mechanical strength test

With the SRME in its extended position, a force in addition to the weight of the SRME is to be applied downwards through the centre of gravity for 1 min.

The additional force applied to the slide-rails shall be equal to the greater of the following two values:

- 50 % of the SRME weight plus a force of 330 N; or*
- 50 % of the SRME weight, plus an additional weight, where the additional weight is equal to the SRME weight or a force of 530 N, whichever is less.*

NOTE This additional force is intended to take into account other items or devices that are stacked on top of the installed SRME while in the extended position during installation of other SRME.

For slide-rail mounted shelves, the shelf shall be tested with a weight of 125 % of the maximum weight that is intended to be placed on the shelf.

A marking shall be provided on the shelf to indicate the maximum weight that can be added to the shelf.

8.11.4 Mechanical strength test, 250 N, including end stops

A 250 N static push force is applied laterally, in both directions at or near the end of the SRME with the slide rails in their fully extended (service) position for a period of 1 min. The applied weight need not be in full contact with uneven surfaces (for example, corrugated or curved surfaces) but shall be concentrated within 30 mm of the end of the SRME.

To test the integrity of the end stops, a 250 N pull and push force is applied at the front of the SRME in an attempt to cause the SRME to come off the slide-rail. The test is performed with the SRME in both the fully extended (service) position and the installed (use) position.

NOTE Additional requirements for a dynamic force test on end stops are being considered at this time.

8.11.5 Compliance criteria

Compliance is checked by inspection and available manufacturer's data. If data is not available, then the tests according to 8.11.3 and 8.11.4 are conducted.

Following each test, the SRME and its associated slide-rails shall remain secure for one complete cycle of travel on its slide-rails. If the mounting means is not able to perform one complete cycle without binding, a force of 100 N shall be applied horizontally to the front of the SRME at its centre point with the intent to completely retract the SRME into the rack.

The mounting means shall not bend or buckle to any extent that could introduce an injury. End stops shall retain the SRME in a safe position and shall not allow the SRME to slide past the end of the slide-rails.

8.12 Telescoping or rod antennas

A telescoping or rod antenna shall be provided with a minimum 6,0 mm diameter button or ball on the end. An antenna end piece and the sections of a telescoping antenna shall be secured in such a manner as to prevent removal.

Compliance is checked by inspection and the test of Clause T.11.

9 Thermal burn injury

9.1 General

To reduce the likelihood of painful effects and injury due to thermal burns, equipment shall be provided with the **safeguards** specified in Clause 9.

NOTE Electric burns due to radio frequency (RF) energy sources are a special case in this standard. They are controlled by limiting accessibility above a specified frequency. These limits and conditions are defined in the notes ^d and ^e defined in Table 4.

9.2 Thermal energy source classifications

9.2.1 General

The different thermal energy sources and their limits under **normal operating conditions**, **abnormal operating conditions** and **single fault conditions** at a normal room ambient of 25 °C are specified below. Touch temperature limits and classifications for various **accessible** parts are given in Table 38.

9.2.2 TS1

TS1 is a class 1 thermal energy source with temperature levels

- not exceeding TS1 limits under **normal operating conditions**; and
- not exceeding TS2 limits under
 - **abnormal operating conditions**; or
 - **single fault conditions**.

9.2.3 TS2

TS2 is a class 2 thermal energy source where:

- the temperature exceeds the TS1 limits; and
- under **normal operating conditions**, **abnormal operating conditions** or **single fault conditions** the temperature does not exceed the TS2 limits.

Where the malfunction of the equipment is evident, no limits apply.

9.2.4 TS3

TS3 is a class 3 thermal energy source where the temperature exceeds the TS2 limits in Table 38 under **normal operating conditions** or under **abnormal operating conditions**, or under **single fault conditions**.

9.2.5 Test method and compliance criteria

The temperature tests are run with the room ambient conditions as defined in B.1.6, except that the room ambient temperature shall be 25_{+0}^{-5} °C. If the test is performed at a temperature deviating from 25 °C, the results are adjusted to reflect a value of 25 °C.

*The equipment shall be operated in a manner the manufacturer determines likely to result in elevated thermal conditions of **accessible** surfaces and parts.*

NOTE This may not be the condition of maximum input current or wattage but the condition that delivers the highest thermal level to the part in question.

*Compliance is checked by measuring the steady state temperature of **accessible** surfaces.*

9.2.6 Touch temperature levels

Table 38 – Touch temperature limits for accessible parts

	Accessible parts ^a	Maximum temperature (T_{max}) °C			
		Metal ^f	Glass, porcelain and vitreous material	Plastic and rubber	Wood
TS1	Handles, knobs, grips, etc., and external surfaces either held, touched or worn against the body in normal use (> 1 min) ^{b, c}	48	48	48	48
	Handles, knobs, grips, etc., and external surfaces held for short periods of time or touched occasionally (> 10 s and < 1 min) ^c	51	56	60	60
	Handle, knobs, grips etc., and external surfaces touched occasionally for very short periods (> 1 s and < 10 s) ^c	60	71	77	107
	External surfaces that need not be touched to operate the equipment (< 1 s) ^c	70 ^d	80 ^d	94 ^d	140
TS2	Handles, knobs, grips, etc., and external surfaces held in normal use (> 1 min) ^c	58	58	58	58
	Handles, knobs, grips, etc., and external surfaces held for short periods of time or touched occasionally (> 10 s and < 1 min) ^d	61	66	70	70
	Handle, knobs, grips etc., and external surfaces touched occasionally for very short periods (> 1 s and < 10 s) ^d	70	81	87	117
	External surfaces that need not be touched to operate the equipment (< 1 s) ^d	80 (100) ^e	90 (100) ^e	104	150
TS3	Higher than the TS2 limits				
<p>^a Except for handles, knobs, grips etc., the following parts inside the equipment need not comply with this table provided an instructional safeguard in accordance with Clause F.5 is provided on or near the hot part (see 9.4.2): a part that does not need to be touched to operate the equipment and if unintentional contact with the part is unlikely; internal parts of the equipment requiring heat for the intended function (for example, a document laminator, thermal print head, fuser heater, etc.) provided the parts are unlikely to be touched by an ordinary person under normal operating conditions.</p> <p>^b For parts in continuous contact with the skin, lower temperatures should be considered, see IEC Guide 117.</p> <p>^c Examples of these surfaces include a telephone handset, a headset, the palm rest surface of a notebook computer and surfaces that need to be touched for disconnection.</p> <p>^d Time of contact shall be determined by the manufacturer and shall be consistent with the intended use in accordance with the equipment instructions</p> <p>For outside parts of metal that are covered with plastic material of at least 0,3 mm thick, a temperature rise which corresponds to the temperature limit of the plastic and rubber is allowed.</p> <p>^e The values in parentheses may be used for the following areas and external surfaces:</p> <ul style="list-style-type: none"> – an area on the external surface of the equipment that has no dimension exceeding 50 mm, and that is not likely to be touched in normal use; or – accessible surfaces of the equipment requiring heat for the intended function (for example, equipment that contains a document laminator, thermal print head, fuser heater, etc.), and that are not likely to be touched in normal use; or – heatsinks and metallic parts directly covering heatsinks, except those on surfaces incorporating switches or controls handled during normal use. <p>For these areas and parts, an instructional safeguard in accordance with Clause F.5 shall be provided on or near the hot part.</p> <p>Under abnormal operating conditions and single fault conditions, for other areas and external surfaces of the equipment, an equipment basic safeguard is required.</p> <p>^f For external metal parts that are covered with plastic or rubber material of at least 0,3 mm thick, the temperature limit of plastic and rubber is allowed.</p>					

9.3 Safeguards against thermal energy sources

Except as given below, safeguard requirements for parts **accessible to ordinary persons, instructed persons and skilled persons** are given in 4.3.

For protection of an **ordinary person** against TS2, an **instructional safeguard** in accordance with 9.4.2 may be used as **basic safeguard** (see condition ^e of Table 38).

For protection of an **ordinary person** or an **instructed person** against TS3, the **supplementary safeguard** may be replaced with an **instructional safeguard** in accordance with 9.4.2. Parts and surfaces classed TS3 shall be provided with an **equipment safeguard** or provided with an **instructional safeguard** so that unintentional contact with such parts and surfaces during service operations is unlikely to cause the **skilled person** to recoil into other class 3 energy sources (see Figure 19).

9.4 Requirements for safeguards

9.4.1 Equipment safeguard

An **equipment safeguard** shall limit the transfer of thermal energy (source temperature) under **normal operating conditions** and **abnormal operating conditions** or limit accessibility to a thermal energy source to a touch temperature as classified in Table 38.

Temperature limits are applied only for those **abnormal operating conditions** where the equipment continues to operate in accordance with the manufacturer's instructions and, hence, the **abnormal operating condition** is not obvious. If the equipment stops functioning, then the limits are not applicable.

9.4.2 Instructional safeguard

An **instructional safeguard** shall be provided in accordance with Clause F.5, except that element 3 is optional.

The elements of the **instructional safeguard** shall be as follows:

- element 1a: , IEC 60417-5041 (2002-10)
- element 2: “CAUTION” and “Hot surface” or equivalent word or text
- element 3: optional
- element 4: “Do not touch” or equivalent text

10 Radiation

10.1 General

To reduce the likelihood of painful effects and injury due to laser, visible, infra-red, ultraviolet, x-ray, and acoustic energy, equipment shall be provided with the **safeguards** specified in this clause.

10.2 Radiation energy source classifications

10.2.1 General classification

Radiation energy source classifications are given in Table 39.

Table 39 – Radiation energy source classifications

Line	Category	RS1	RS2	RS3
1	Lasers	Class 1 ^a	Class 1M, Class 2, Class 2M, and Class 3R (visible) ^a	Class 3R (invisible), Class 3B, and Class 4 ^a
2	Lamps and LEDs	Exempt group, RG-1 and RG-2 ^b		RG-3 ^b
3	X-Ray	≤ 36 pA/kg at 50 mm ^c	> RS1 and ≤ 185 pA/kg at 100 mm ^d	> RS2
4	Acoustic	≤ 85 dB(A)	> RS1 and ≤ 100 dB(A)	> RS2

^a The different classes are defined in IEC 60825-1.

^b The different classes are defined in IEC 62471. Low power application of LEDs are in the exempt group.

UV radiation from general purpose incandescent and fluorescent lamps, with ordinary glass envelopes, are taken as RS1.

EXAMPLE RS1 LEDs are those used as:

indicating lights;

infra-red devices such as used in home entertainment devices;

infra-red devices for data transmission such as used between computers and computer peripherals;

optocouplers; and

other similar low power devices.

NOTE 1 If optical radiation is broadband visible and IR-A radiation and the luminance of the source does not exceed 10^4 cd/m², it is expected that the radiation does not exceed the exposure limits given in 4.3 of IEC 62471:2006 (see 4.1 of IEC 62471:2006).

For UV-C limits (wavelengths between 180 nm and 200 nm), the value of IEC 62471 for 200 nm is used.

^c 36 pA/kg equals 5 μSv/h or 0,5 mR/h. This value is consistent with International Commission on Radiation Protection (ICRP) Publication 60.

^d 185 pA/kg equals 25 μSv/h or 2,5 mR/h.

Measurement is made with any part of the cabinet, case, and chassis removed per maintenance instructions (CRT exposed) at the maximum test voltage applicable and under the conditions as specified below.

NOTE 2 In the member countries of CENELEC, the amount of ionizing radiation is regulated by European Council Directive 96/29/Euratom of 13 May 1996. This Directive requires that at any point 100 mm from the surface of the equipment, the dose-rate shall not exceed 1 μSv/h (0,1 mR/h) taking account of the background level. For complete requirements refer to the above Directive.

NOTE 3 In the USA, the measuring conditions in the U.S. Code of Federal Regulations Title 21 Part 1020 are as given below (for complete requirements, refer to the above regulations).

Measurements are made with the EUT connected to the following source of supply:

- 130 V if the **rated voltage** is between 110 V and 120 V;
- 110 % of the **rated voltage**, if the **rated voltage** is not between 110 V and 120 V.

During the measurements:

- all user and service **accessible** controls are adjusted to combinations that produce maximum x-radiation emissions; and
- **abnormal operating conditions** of any component or circuit malfunction causing an increase of x-radiation emissions are to be simulated.

NOTE 4 In Canada, the measuring conditions in the Consolidated Regulations of Canada, c.1370 are as given below (for complete requirements refer to the above regulations).

Measurements are made with the EUT connected to the following source of supply:

- 127 V if the **rated voltage** is between 110 V and 120 V;
- 110 % of the **rated voltage**, if the **rated voltage** is not between 110 V and 120 V.

During the measurements all user and service **accessible** controls are adjusted to combinations that produce maximum x-radiation emissions.

10.2.2 RS1

RS1 is a class 1 radiation energy source that

- does not exceed RS1 limits under
 - **normal operating conditions**, and
 - **abnormal operating conditions** that do not lead to a **single fault condition**, and
 - **single fault conditions** for laser, visible, infra-red, ultra-violet and x-radiation; and
- does not exceed RS2 limits under
 - **single fault conditions** for acoustic radiation.

10.2.3 RS2

RS2 is a class 2 radiation energy source that does not exceed RS2 limits under

- **normal operating conditions**, and
- **abnormal operating conditions**, and
- **single fault conditions**, and

is not RS1.

10.2.4 RS3

RS3 is a class 3 radiation energy source that exceeds RS2 limits under

- **normal operating conditions**, or
- **abnormal operating conditions**, or
- **single fault conditions**.

10.3 Safeguards against laser radiation

10.3.1 Requirements

Equipment containing one or more lasers (including laser diodes) shall comply with IEC 60825-1, IEC 60825-2 or IEC 60825-12 as applicable.

Diodes emitting coherent light shall be treated as laser radiation.

NOTE In IEC 60825-1, such diodes are identified as “laser diodes”.

Unless RS2 is required to be **accessible** for the function of the equipment, laser radiation that exits the equipment shall not exceed RS1 under **normal operating conditions**, **abnormal operating conditions**, and **single fault conditions**. If RS2 is required to be **accessible** for the function of the equipment, the equipment shall be provided with an **instructional safeguard** in accordance with IEC 60825-1.

Unless the equipment complies with IEC 60825-2, where an RS3 laser is present, a **tool** shall be required to gain access.

10.3.2 Compliance criteria

Compliance is determined by measurement or by checking the available manufacturer's data sheet.

10.4 Safeguards against visible, infra-red, and ultra-violet radiation

10.4.1 General

Except as given below, protection requirements for parts **accessible to ordinary persons, instructed persons, and skilled persons** are given in 4.3.

For an **ordinary person** or an **instructed person**, RS3 shall be contained by the **enclosure** of the lamps and lamp system or the **enclosure** of the equipment.

If RS3 is **accessible** to a **skilled person**, then a **personal safeguard** (PPE) shall be required, and an **instructional safeguard** in accordance with 10.4.2 shall be provided.

Unless RS2 is required to be **accessible** for the function of the equipment, visible, infra-red, and ultra-violet radiation **accessible** to an **ordinary person** or an **instructed person** shall not exceed RS1 under **normal operating conditions, abnormal operating conditions and single fault conditions**. If RS2 is required to be **accessible** for the function of the equipment, the equipment shall be provided with an **instructional safeguard** in accordance with IEC/TR 62471-2.

Enclosure material used as a **safeguard** shall be opaque to the radiation. An opaque **enclosure** that complies with the test of Annex T according to 4.4.4 is taken as a **reinforced safeguard**.

UV radiation emitted through glass having a 90 % UV attenuation up to 400 nm is taken as RS1. Glass with a thickness of 2 mm is considered to have such attenuation.

Materials that comprise a **safeguard** and are exposed to UV radiation from a lamp in the equipment shall be sufficiently resistant to degradation to the extent that the **safeguard** function remains effective for the equipment lifetime. Metal, glass and ceramic materials do not need to be assessed.

Equipment with optical energy sources in excess of the limits specified in IEC 62471 in the wavelength range 200 nm to 3 000 nm impinging on the human body shall be provided with the **safeguards** specified in this subclause.

In general, optical radiation from the equipment shall either:

- be contained by the **enclosure** of the lamps and lamp system or the **enclosure** of the equipment; or
- not exceed the relevant limits for the exempt group given in IEC 62471 for **normal operating conditions**.

10.4.2 Instructional safeguard

Where required, an **instructional safeguard** shall be in accordance with Clause F.5.

The elements of the **instructional safeguard** shall be as follows:

- element 1a: the UV radiation symbol , IEC 60417-6040 (2010-08), or

the visible radiation symbol , IEC 60417-6041 (2010-08), or

the infrared radiation symbol , IEC 60417-6151 (2012-02)

- element 2: “UV light”, “Bright light” or “Infrared light” as applicable, or equivalent text
- element 3: “Possible skin or eye damage” or equivalent text
- element 4: “Disconnect power before servicing” or equivalent text

Alternatively, the cautionary statement for Risk Groups RG-1 and RG-2 specified in IEC/TR 62471-2 may be used as an **instructional safeguard**.

If the **safeguard** is a **safety interlock**, then an **instructional safeguard** is not required.

10.4.3 Compliance criteria

Compliance is checked by evaluation of available data sheets, by inspection and, if necessary, by measurement.

NOTE For guidance on measuring techniques, see IEC 62471.

Compliance against material degradation from UV radiation is checked by the relevant tests in Annex C.

10.5 Safeguards against x-radiation

10.5.1 Requirements

Equipment x-radiation that exits the equipment shall not exceed RS1 under **normal operating conditions**, **abnormal operating conditions**, and **single fault conditions**.

An **equipment safeguard** is required between RS2 or RS3 and all persons.

Doors and covers acting as a **safeguard** that, when open, would allow access to RS2 or RS3 for a **skilled person** shall be provided with an **instructional safeguard** in accordance with Clause F.5.

10.5.2 Compliance criteria

Compliance is checked by inspection and, where necessary, by the test of 10.5.3.

10.5.3 Test method

Equipment that is likely to produce ionizing radiation is checked by measuring the amount of radiation. Account is taken of the background level.

The amount of radiation is determined by means of a radiation monitor of the ionizing chamber type with an effective area of 1 000 mm² or by measuring equipment of other types giving equivalent results.

*Measurements are made with the EUT operating at the most unfavourable supply voltage (see B.2.3) and with controls for an **ordinary person** and an **instructed person**, and controls for a **skilled person** that are not locked in a reliable manner, adjusted so as to give maximum radiation whilst maintaining the equipment operative for normal use.*

NOTE 1 Soldered joints and fixing by application of paint, epoxy, or similar materials are considered reliable locking means.

*Moreover, the measurement shall be made under any **abnormal operating condition** and **single fault conditions** that can cause an increase of the high-voltage, provided an intelligible picture is maintained for 5 min, at the end of which the measurement is made and averaged over 5 min.*

During the measurements, an intelligible picture is to be maintained.

A picture is considered to be intelligible if the following conditions are met:

- a scanning amplitude of at least 70 % of the usable screen for both width and height;
- a minimum luminance of 50 cd/m² with locked blank raster provided by a test generator;
- not more than 12 flashovers in a 1 h period;
- a horizontal resolution corresponding to at least 1,5 MHz in the centre with a similar vertical degradation.

NOTE 2 In the USA and Canada, an intelligible picture is in synchronization while covering 60 % of the viewable screen area.

10.6 Safeguards against acoustic energy sources

10.6.1 General

Safeguard requirements for protection against long-term exposure to excessive sound pressure levels from personal music players closely coupled to the ear are specified below. Requirements for earphones and headphones intended for use with personal music players are also covered.

A personal music player is a portable equipment intended for use by an **ordinary person**, that:

- is designed to allow the user to listen to audio or audiovisual content / material; and
- uses a listening device, such as headphones or earphones that can be worn in or on or around the ears; and
- has a player that can be body worn (of a size suitable to be carried in a clothing pocket) and is intended for the user to walk around with while in continuous use (for example, on a street, in a subway, at an airport, etc.).

NOTE 1 Examples are portable CD players, MP3 audio players, mobile phones with MP3 type features, PDAs or similar equipment.

Personal music players shall comply with the requirements below.

NOTE 2 Protection against acoustic energy sources from telecom applications is referenced to ITU-T P.360.

These requirements are valid for music or video mode only.

The requirements do not apply to:

- professional equipment;

NOTE 3 Professional equipment is equipment sold through special sales channels. All products sold through normal electronics stores are considered not to be professional equipment.

- hearing aid equipment and other devices for assistive listening;
- the following type of analogue personal music players:
 - long distance radio receiver (for example, a multiband radio receiver or world band radio receiver, an AM radio receiver), and
 - cassette player/recorder;

NOTE 4 This exemption has been allowed because this technology is falling out of use and it is expected that within a few years it will no longer exist. This exemption will not be extended to other technologies.

- a player while connected to an external amplifier that does not allow the user to walk around while in use.

10.6.2 Classification

10.6.2.1 RS1 limits

RS1 is a class 1 acoustic energy source that does not exceed the following:

- for equipment provided as a package (player with its listening device), the $L_{Aeq,T}$ acoustic output shall be ≤ 85 dB(A) when playing the fixed “programme simulation noise” described in EN 50332-1.
- for equipment provided with an electrical output socket for a listening device, the unweighted r.m.s. output voltage shall be ≤ 27 mV or 25 dB below full scale when playing the fixed “programme simulation noise” described in EN 50332-1.

NOTE 1 Unless otherwise specified, wherever the term acoustic output is used in 10.6, $L_{Aeq,T}$ is the A-weighted equivalent sound pressure level over a 30 s period.

For music where the average sound pressure (long term $L_{Aeq,T}$) measured over the duration of the song is lower than the average produced by the programme simulation noise, the warning does not need to be given as long as the average sound pressure of the song does not exceed the basic limit of 85 dB(A). In this case, T becomes the duration of the song.

NOTE 2 Classical music typically has an average sound pressure (long term $L_{Aeq,T}$) which is much lower than the average programme simulation noise. Therefore, if the player is capable to analyse the song and compare it with the programme simulation noise, the warning does not need to be given as long as the average sound pressure of the song does not exceed the basic limit of 85 dB(A).

For example, if the player is set with the programme simulation noise to 85 dB(A), but the average music level of the song is only 65 dB(A), there is no need to give a warning or ask an acknowledgement as long as the average sound level of the song is not above the basic limit of 85 dB(A).

For equipment that is clearly designed or intended for use by children, the limits of the relevant toy standards may apply.

NOTE 3 In Europe, the relevant requirements are given in EN 71-1:2011, 4.20 and the related tests methods and measurement distances apply.

10.6.2.2 RS2 limits

RS2 is a class 2 acoustic energy source that does not exceed the following:

- for equipment provided as a package (player with its listening device), the $L_{Aeq,T}$ acoustic output shall be ≤ 100 dB(A) when playing the fixed “programme simulation noise” as described in EN 50332-1.
- for equipment provided with an electrical output socket for a listening device, the unweighted r.m.s. output voltage shall be ≤ 150 mV or 10 dB below full scale when playing the fixed “programme simulation noise” as described in EN 50332-1.

10.6.2.3 RS3 limits

RS3 is a class 3 acoustic energy source that exceeds RS2 limits.

10.6.3 Measurement methods

All volume controls shall be turned to maximum during tests.

Measurements shall be made in accordance with EN 50332-1 or EN 50332-2 as applicable.

10.6.4 Protection of persons

Except as given below, protection requirements for parts **accessible to ordinary persons, instructed persons and skilled persons** are given in 4.3.

NOTE 1 Volume control is not considered a **safeguard**.

Between RS2 and an **ordinary person**, the **basic safeguard** may be replaced by an **instructional safeguard** in accordance with Clause F.5, except that the **instructional safeguard** shall be placed on the equipment, or on the packaging, or in the instruction manual. Alternatively, the **instructional safeguard** may be given through the equipment display during use.

The elements of the **instructional safeguard** shall be as follows:

- element 1a: the symbol , IEC 60417-6044 (2011-01)
- element 2: “High sound pressure” or equivalent wording
- element 3: “Hearing damage risk” or equivalent wording
- element 4: “Do not listen at high volume levels for long periods.” or equivalent wording

An **equipment safeguard** shall prevent exposure of an **ordinary person** to RS2 power source without intentional physical action from the **ordinary person** and shall automatically return to an output level not exceeding RS1 when the power is switched off.

The equipment shall provide a means to actively inform the user of the increased sound pressure when the equipment is operated with an acoustic output exceeding RS1. Any means used shall be acknowledged by the user before activating a mode of operation which allows for an acoustic output exceeding RS1. The acknowledgement does not need to be repeated more than once every 20 h of cumulative listening time.

NOTE 2 Examples of means include visual or audible signals. Action from the user is always needed.

NOTE 3 The 20 h listening time is the accumulative listening time, independent of how often and how long the personal music player has been switched off.

A **skilled person** shall not be unintentionally exposed to RS3.

10.6.5 Requirements for listening devices (headphones, earphones, etc.)

10.6.5.1 Corded passive listening devices with analogue input

With 94 dB(A) L_{Aeq} acoustic pressure output, the input voltage of the fixed “programme simulation noise” as described in EN 50332-1 shall be ≥ 75 mV.

This requirement is applicable in any music play mode where the headphones can operate, including any available setting (for example, a built-in volume level control, an additional sound feature like equalization, etc.).

NOTE The values of 94 dB(A) and 75 mV correspond with 85 dB(A) and 27 mV or 100 dB(A) and 150 mV.

10.6.5.2 Corded listening devices with digital input

With any playing device playing the fixed “programme simulation noise” described in EN 50332-1, the $L_{Aeq,T}$ acoustic output of the listening device shall be ≤ 100 dB(A).

This requirement is applicable in any music play mode where the headphones can operate, including any available setting (for example, a built-in volume level control, an additional sound feature like equalization, etc.).

10.6.5.3 Cordless listening devices

In cordless mode,

- with any playing and transmitting device playing the fixed programme simulation noise described in EN 50332-1; and
- respecting the cordless transmission standards, where an air interface standard exists that specifies the equivalent acoustic level; and
- with volume and sound settings in the receiving device (for example, built-in volume level control, additional sound feature like equalization, etc.) set to the combination of positions that maximize the measured acoustic output for the above mentioned programme simulation noise,

the $L_{Aeq,T}$ acoustic output of the listening device shall be ≤ 100 dB(A).

10.6.5.4 Measurement method

Measurements shall be made in accordance with EN 50332-2 as applicable.

Annex A (informative)

Examples of equipment within the scope of this standard

Some examples of equipment within the scope of this standard are:

Generic product type	Specific example of generic type
Banking equipment	Monetary processing machines including automated teller (cash dispensing) machines (ATM)
Consumer electronic equipment (including professional audio, video and musical instrument equipment)	Receiving equipment and amplifiers for sound and/or vision, supply equipment intended to supply other equipment covered by the scope of this standard, electronic musical instruments, and electronic accessories such as rhythm generators, tone generators, music tuners and the like for use with electronic or non-electronic musical instruments, audio and/or video educational equipment, video projectors, video cameras and video monitors, video games, juke boxes, record and optical disc players, tape and optical disc recorders, antenna signal converters and amplifiers, antenna positioners, Citizen's Band equipment, equipment for imagery, electronic light effect equipment, intercommunication equipment using low voltage mains as the transmission medium, cable head-end receivers, multimedia equipment, electronic flash equipment
Data and text processing machines and associated equipment	Data preparation equipment, data processing equipment, data storage equipment, personal computers, plotters, printers, scanners, text processing equipment, visual display units
Data network equipment	Bridges, data circuit terminating equipment, data terminal equipment, routers
Electrical and electronic retail equipment	Cash registers, point of sale terminals including associated electronic scales
Electrical and electronic office machines	Calculators, copying machines, dictation equipment, document shredding machines, duplicators, erasers, micrographic office equipment, motor-operated files, paper trimmers (punchers, cutting machines, separators), paper jogging machines, pencil sharpeners, staplers, typewriters
Other information technology equipment	Photoprinting equipment, public information terminals, multimedia equipment
Postage equipment	Mail processing machines, postage machines
Telecommunication network infrastructure equipment	Billing equipment, multiplexers, network powering equipment, network terminating equipment, radio base stations, repeaters, transmission equipment, telecommunication switching equipment
Telecommunication terminal equipment	Facsimile equipment, key telephone systems, modems, PABXs, pagers, telephone answering machines, telephone sets (wired and wireless)

This list is not intended to be all-inclusive, and equipment that is not listed is not necessarily excluded from the scope.

Annex B (normative)

Normal operating condition tests, abnormal operating condition tests and single fault condition tests

B.1 General

B.1.1 Introduction

This annex specifies various tests and test conditions applicable to the equipment.

B.1.2 Test applicability

If it is evident that a particular test is not applicable, or not necessary after inspection of available data, the test shall not be made. Tests in this standard shall be conducted only if safety is involved.

In order to establish whether or not a test is applicable, the circuits and construction shall be carefully investigated to take into account the consequences of possible faults. The consequence of a fault may or may not require the use of a **safeguard** to reduce the likelihood of injury or fire.

B.1.3 Type of test

Except where otherwise stated, tests specified are **type tests**.

B.1.4 Test samples

Unless otherwise specified, the sample under test shall be representative of the actual equipment or shall be the actual equipment.

As an alternative to conducting tests on the complete equipment, tests may be conducted separately on circuits, components or sub-assemblies outside the equipment, provided that inspection of the equipment and circuit arrangements ensure that such testing will indicate that the assembled equipment would conform to the requirements of the standard. If any such test indicates the likelihood of non-conformance in the complete equipment, the test shall be repeated in the equipment.

If a test could be destructive, a model may be used to represent the condition to be evaluated.

B.1.5 Compliance by inspection of relevant data

Where in this standard compliance of materials, components or subassemblies is checked by inspection or by testing of properties, compliance may be confirmed by reviewing any relevant data or previous test results that are available instead of carrying out the specified **type tests**.

B.1.6 Temperature measurement conditions

The test measurement set-up shall reproduce the most severe equipment installation conditions. Where a maximum temperature (T_{\max}) is specified for compliance with tests, it is based on the assumption that the room ambient air temperature will be 25 °C when the equipment is operating. However, the manufacturer may specify a different maximum ambient air temperature.

Measurements are made with the EUT operating at the most unfavourable supply voltage (see B.2.3).

Unless otherwise specified, it is not necessary to maintain the ambient temperature (T_{amb}) at a specific value during tests, but it shall be monitored and recorded.

With reference to those tests that are to be continued until steady state temperatures are attained, steady state is considered to exist if the temperature rise does not exceed 3 K in 30 min. If the measured temperature is at least 10 % less than the specified temperature limit, steady state is considered to exist if the temperature rise does not exceed 1 K in 5 min.

Unless a particular method is specified, temperatures of windings shall be determined either by the thermocouple method or by any other method giving the average temperature of the winding wires such as the resistance method.

B.2 Normal operating conditions

B.2.1 General

Except where specific test conditions are stated elsewhere and where it is clear that there is a significant impact on the results of the test, the tests shall be conducted under the most unfavourable **normal operating conditions** taking into account the following parameters:

- supply voltage;
- supply frequency;
- environmental conditions (for example, the manufacturer's rated maximum ambient temperature);
- physical location of equipment and position of movable parts, as specified by the manufacturer;
- operating mode, including external loading due to interconnected equipment;
- adjustment of a control.

For audio amplifiers and equipment containing an audio amplifier, additional test conditions apply, see Annex E.

B.2.2 Supply frequency

In determining the most unfavourable supply frequency for a test, different frequencies within the **rated frequency** range shall be taken into account (for example, 50 Hz and 60 Hz) but consideration of the tolerance on a **rated frequency** (for example, 50 Hz \pm 0,5 Hz) is not necessary.

B.2.3 Supply voltage

In determining the most unfavourable supply voltage for a test, the following variables shall be taken into account:

- multiple **rated voltages**;
- extremes of **rated voltage ranges**; and
- tolerance on **rated voltage** as declared by the manufacturer.

Unless the manufacturer declares a wider tolerance, the minimum tolerance shall be taken as +10 % and –10 % for a.c. **mains** and +20 % and –15 % for d.c. **mains**. Equipment intended by the manufacturer to be restricted to connection to a conditioned power supply system (for example, a UPS) may be provided with a narrower tolerance if the equipment is also provided with instructions specifying such restriction.

Where a test subclause does not require the most unfavourable supply voltage (by not making a specific reference to B.2.3), the supply voltage is the value of the **rated voltage** or any value in the **rated voltage range**.

B.2.4 Normal operating voltages

The following voltages shall be considered:

- normal operating voltages generated in the equipment, including repetitive peak voltages such as those associated with switch mode power supplies;
- normal operating voltages generated external to the equipment, including ringing signals received from **external circuits** as indicated in Table 14, ID numbers 1 and 2.

Externally generated **mains transient voltages** and **external circuit** transient voltages shall not be considered:

- when determining **working voltages**, because such transients have been taken into account in the procedures for determining minimum **clearances** (see 5.4.2);
- when classifying circuits in the equipment as ES1, ES2 and ES3 (see 5.2).

B.2.5 Input test

In determination of the input current or input power, the following variables shall be considered:

- loads due to optional features, offered or provided for by the manufacturer for inclusion in or with the EUT;
- loads due to other units of equipment intended by the manufacturer to draw power from the EUT;
- loads that could be connected to any standard supply outlet on the equipment that is **accessible** to an **ordinary person**, up to the value specified by the manufacturer;
- for equipment containing an audio amplifier, see Clause E.1;
- for displays with moving images, the following settings shall apply:
 - the 'Three vertical bar signal' shall be used as defined in 3.2.1.3 of IEC 60107-1:1997, and
 - user **accessible** picture controls shall be adjusted so as to obtain the maximum power consumption, and
 - sound settings shall be as defined in Clause E.1 of this standard.

Artificial loads may be used to simulate such loads during testing.

In each case, the readings are taken when the input current or input power has stabilized. If the current or power varies during the normal operating cycle, the steady-state current or power is taken as the mean indication of the value, measured on a recording r.m.s. ammeter or power meter, during a representative period.

The measured input current or input power under **normal operating conditions**, but at the **rated voltage** or at each end of each **rated voltage range**, shall not exceed the **rated current** or **rated power** by more than 10 %.

Compliance is checked by measuring the input current or input power of the equipment under the following conditions:

- where equipment has more than one **rated voltage**, the input current or input power is measured at each **rated voltage**;
- where equipment has one or more **rated voltage ranges**, the input current or input power is measured at each end of each **rated voltage range**
 - where a single value of **rated current** or **rated power** is marked, it is compared with the higher value of input current or input power measured in the associated **rated voltage range**,
 - where two values of **rated current** or **rated power** are marked, separated by a hyphen, they are compared with the two values measured in the associated **rated voltage range**.

B.2.6 Operating temperature measurement conditions

B.2.6.1 General

Temperatures measured on the equipment shall conform to B.2.6.2 or B.2.6.3, as applicable, all temperatures being in degrees Celsius (°C); where

- T is the temperature of the given part measured under the prescribed test conditions;
- T_{\max} is the maximum temperature specified for compliance with the test;
- T_{amb} is the ambient temperature during test;
- T_{ma} is the maximum ambient temperature specified by the manufacturer, or 25 °C, whichever is greater.

B.2.6.2 Operating temperature dependent heating/cooling

For equipment where the amount of heating or cooling is designed to be dependent on temperature (for example, the equipment contains a fan that has a higher speed at a higher temperature), the temperature measurement is made at the least favourable ambient temperature within the manufacturer's specified operating range. In this case, T shall not exceed T_{\max} .

NOTE 1 In order to find the highest value of T for each component, it can be useful to conduct several tests at different values of T_{amb} .

NOTE 2 The least favourable value of T_{amb} can be different for different components.

Alternatively, the temperature measurement may be made under ambient conditions with the heating/cooling device at its least effective setting or with the device defeated.

B.2.6.3 Operating temperature independent heating/cooling

For equipment where the amount of heating or cooling is not designed to be dependent on ambient temperature, the method in B.2.6.2 may be used. Alternatively, the test is performed at any value of T_{amb} within the manufacturer's specified operating range. In this case, T shall not exceed $(T_{\max} + T_{\text{amb}} - T_{\text{ma}})$.

During the test, T_{amb} should not exceed T_{ma} unless agreed by all parties involved.

B.2.7 Battery charging and discharging under normal operating conditions

Under **normal operating conditions**, **battery** charging and discharging conditions shall comply with the requirements of Annex M as applicable.

B.3 Simulated abnormal operating conditions

B.3.1 General

When applying simulated **abnormal operating conditions**, parts, supplies, and media shall be in place if they are likely to have an effect on the outcome of the test.

Each **abnormal operating condition** shall be applied in turn, one at a time.

Faults that are the direct consequence of the **abnormal operating condition** are deemed to be a **single fault condition**.

The equipment, installation, instructions, and specifications shall be examined to determine those **abnormal operating conditions** that might reasonably be expected to occur.

As a minimum, the following examples of **abnormal operating conditions** shall be considered, as applicable, in addition to those mentioned in B.3.2 to B.3.7:

- for paper handling equipment, a paper jam;
- for equipment with controls **accessible** to an **ordinary person**, adjustment of the controls, both individually and collectively, for worst-case operating conditions;
- for audio amplifiers with controls **accessible** to an **ordinary person**, adjustment of the controls, both individually and collectively, for worst-case operating conditions, without applying the conditions specified in Annex E;
- for equipment with moving parts **accessible** to an **ordinary person**, a moving parts jam;
- for equipment with media, incorrect media, incorrect size media, and incorrect media quantity;
- for equipment with replenishable liquids or liquid cartridges, or replenishable materials, liquids or materials spilled into the equipment.

Before introducing any of the above **abnormal operating conditions**, the equipment shall be operating under **normal operating conditions**.

B.3.2 Covering of ventilation openings

The top, sides and the back of equipment, if such surfaces have ventilation openings, shall be covered one at a time with a piece of card (thick, stiff paper or thin cardboard) of 200 g/m² density, with dimensions not less than each tested surface, covering all openings.

Openings on different surfaces on top of the equipment (if any) are covered simultaneously by separate pieces of card.

Openings on top of the equipment, on a surface inclined at an angle greater than 30° and smaller than 60° to the horizontal, from which an obstruction is free to slide, are excluded.

On the back and the sides of the equipment, the card is attached to the upper edge and allowed to hang freely.

Except as specified below, there are no requirements for blocking openings in the bottom of the equipment.

In addition, equipment with ventilation openings likely to be used on a soft support (like bedding, blankets etc.), shall comply with one of the following:

- Openings in the bottom, sides and back of the equipment are to be covered simultaneously. External surfaces shall not exceed the TS2 limits in Table 38.

- An **instructional safeguard** shall be provided in accordance with Clause F.5, except that element 3 is optional.

The elements of the **instructional safeguard** shall be as follows:

- element 1a: not available
- element 2: “Do not cover ventilation openings” or equivalent wording
- element 3: optional
- element 4: “This equipment is not intended to be used on soft support (like beddings, blankets etc.)” or equivalent wording

B.3.3 DC mains polarity test

If the connection to the d.c. **mains** is not polarized and the connection is **accessible** to an **ordinary person**, then the possible influence of polarity shall be taken into account when testing equipment designed for d.c.

B.3.4 Setting of voltage selector

Equipment to be supplied from the **mains** and provided with a voltage setting device to be set by the **ordinary person** or an **instructed person**, is tested with the **mains** voltage setting device at the most unfavourable position.

B.3.5 Maximum load at output terminals

Output terminals of equipment supplying power to other equipment, except socket-outlets directly connected to the **mains**, are connected to the most unfavourable load impedance, including short-circuit.

B.3.6 Reverse battery polarity

If it is possible for an **ordinary person** to insert replaceable **batteries** with reversed polarity, the equipment is tested in all possible configurations with one or more **batteries** reversed (see also Annex M).

B.3.7 Audio amplifier abnormal operating conditions

Abnormal operating conditions for audio amplifiers are specified in Clause E.2.

B.3.8 Compliance criteria during and after abnormal operating conditions

*During an **abnormal operating condition** that does not lead to a **single fault condition**, all **safeguards** shall remain effective. After restoration of **normal operating conditions**, all **safeguards** shall comply with applicable requirements.*

*If an **abnormal operating condition** leads to a consequential fault, the compliance criteria of B.4.8 apply.*

B.4 Simulated single fault conditions

B.4.1 General

When applying simulated **single fault conditions**, parts, supplies, and media shall be in place if they are likely to have an effect on the outcome of the test.

The introduction of any **single fault condition** shall be applied in turn one at a time. Faults, that are the direct consequence of the **single fault condition**, are deemed to be part of that **single fault condition**.

The equipment construction, circuit diagrams, component specifications, including **functional insulation** are examined to determine those **single fault conditions** that might reasonably be expected and that:

- might bypass a **safeguard**, or
- cause the operation of a **supplementary safeguard**, or
- otherwise affect the safety of the equipment.

The following **single fault conditions** shall be considered:

- an **abnormal operating condition** that results in a **single fault condition** (for example, an **ordinary person** overloading external output terminals, or an **ordinary person** incorrectly setting a selector switch);
- a **basic safeguard** failure or a **supplementary safeguard** failure;
- except for integrated circuit current limiters complying with Clause G.9, a component failure simulated by short-circuiting any two leads and open-circuiting any one lead of the component one at a time;
- when required by B.4.4, a failure of **functional insulation**.

B.4.2 Temperature controlling device

Except for temperature controlling **safeguards**, according G.3.1 to G.3.4, any single device or component of a circuit controlling the temperature during temperature measurement shall be open-circuited or short-circuited, whichever is more unfavourable.

Temperatures shall be measured according to B.1.6.

B.4.3 Motor tests

B.4.3.1 Blocked motor test

Motors are blocked or the rotor is locked in the end product if it is obvious that such an action will result in an increase in internal ambient temperature of the equipment (for example, locking the rotor of the fan motor to stop air flow).

B.4.3.2 Compliance criteria

Compliance is checked by inspection and examination of the available data or by testing according to G.5.4.

B.4.4 Functional insulation

B.4.4.1 Clearances for functional insulation

Unless the **clearance** for **functional insulation** complies with:

- the **clearance** for **basic insulation** as specified in 5.4.2; or
- the electric strength test of Table 26 for **basic insulation**;

a **clearance** for **functional insulation** shall be short-circuited.

B.4.4.2 Creepage distances for functional insulation

Unless the **creepage distance** for **functional insulation** complies with:

- the **creepage distance** for **basic insulation** as specified in 5.4.3; or
- the electric strength test of 5.4.9.1 for **basic insulation**;

a **creepage distance** for **functional insulation** shall be short-circuited.

B.4.4.3 Functional insulation on coated printed boards

Unless the **functional insulation** complies with:

- the separation distance of Table G.13; or
- the electric strength test of 5.4.9.1 for **basic insulation**;

a **functional insulation** on a coated printed board shall be short-circuited.

B.4.5 Short-circuit and interruption of electrodes in tubes and semiconductors

Electrodes in electronic tubes and leads of semiconductor devices shall be short-circuited, or if applicable, interrupted. One lead at a time is interrupted or any two leads connected together in turn. See B.4.1 for exceptions to this test.

B.4.6 Short-circuit or disconnection of passive components

Resistors, capacitors, windings, loudspeakers, VDRs and other passive components shall be short-circuited or disconnected, whichever is more unfavourable.

These **single fault conditions** do not apply to:

- PTC thermistors complying with IEC 60730-1:2010, Clauses 15, 17, J.15 and J.17;
- a PTC providing IEC 60730-1 Type 2.AL action;
- resistors complying with the tests of 5.5.6;
- capacitors complying with IEC 60384-14 and assessed according to 5.5.2 of this standard;
- isolating components (for example, optocouplers and transformers) complying with the relevant component requirements in Annex G for **reinforced insulation**; and
- other components that serve as a **safeguard** complying with the relevant requirements of Annex G or with the safety requirements of the relevant IEC component standard.

B.4.7 Continuous operation of components

*Motors, relay coils or the like, intended for **short-time operation** or **intermittent operation**, are operated continuously if this can occur during operation of the equipment.*

*For equipment rated for **short-time operation** or **intermittent operation**, the test is repeated until steady-state conditions are reached, irrespective of the operating time. For this test, the **thermostats**, **temperature limiters** and **thermal cut-offs** are not short-circuited.*

*In circuits not directly connected to the **mains** and in circuits supplied by a d.c. power distribution system, electromechanical components normally energized intermittently, except for motors, a fault shall be simulated in the drive circuit to cause continuous energizing of the component.*

The duration of the test shall be as follows:

- *for equipment or components whose failure to operate is not evident to an **ordinary person**, as long as necessary to establish steady conditions or up to the interruption of the circuit due to other consequences of the simulated fault condition, whichever is the shorter; and*
- *for other equipment and components: 5 min or up to interruption of the circuit due to a failure of the component (for example, burn-out) or to other consequences of the simulated fault condition, whichever is shorter.*

B.4.8 Compliance criteria during and after single fault conditions

*During and after a **single fault condition**, an **accessible** part shall not exceed the relevant energy class as specified in 5.3, 8.3, 9.3, 10.3, 10.4.1, 10.5.1 and 10.6.4 for the related person depending on the hazard involved. During and after **single fault conditions**, any flame inside the equipment shall extinguish within 10 s and no surrounding parts shall have ignited. Any part showing flames shall be regarded as a **PIS**.*

B.4.9 Battery charging and discharging under single fault conditions

Under **single fault conditions**, **battery** charging and discharging conditions shall comply with the requirements of Annex M as applicable.

Annex C (normative)

UV radiation

C.1 Protection of materials in equipment from UV radiation

C.1.1 General

This annex defines the test requirements and test procedures for materials that have safety properties and that are subject to UV radiation exposure.

C.1.2 Requirements

The following requirements apply only to equipment containing lamps that produce significant UV radiation in the spectrum 180 nm to 400 nm, as specified by the lamp manufacturer.

NOTE 1 General-purpose incandescent and fluorescent lamps, with ordinary glass envelopes, are not considered to emit significant UV radiation.

NOTE 2 Filters and/or lenses usually act as a **safeguard** and can serve as part of the **enclosure**.

Table C.1 – Minimum property retention limits after UV exposure

Parts to be tested	Property	Standard for the test method	Minimum retention after test
Parts providing mechanical support	Tensile strength ^a or flexural strength ^{a b}	ISO 527 series	70 %
		ISO 178	70 %
Parts providing impact resistance	Charpy impact ^c or Izod impact ^c or Tensile impact ^c	ISO 179-1	70 %
		ISO 180	70 %
		ISO 8256	70 %
All parts	Material flammability class	See Clause S.4 of this standard	^d

^a Tensile strength and flexural strength tests are to be conducted on specimens no thicker than the actual thicknesses.

^b The side of the sample exposed to UV radiation is to be in contact with the two loading points when using the three point loading method.

^c Tests conducted on 3,0 mm thick specimens for Izod impact and tensile impact tests and 4,0 mm thick specimens for Charpy impact tests are considered representative of other thicknesses, down to 0,75 mm.

^d The **material flammability class** may change as long as it does not fall below that specified in Clause 6 of this standard.

C.1.3 Test method and compliance criteria

Compliance is checked by examination of the construction and of available data regarding the UV resistance characteristics of the parts exposed to UV radiation in the equipment. If such data is not available, the tests in Table C.1 are carried out on the parts.

Samples taken from the parts, or consisting of identical material, are prepared according to the standard for the test to be carried out. They are then exposed to UV radiation (conditioned) according to Clause C.2. After conditioning, the samples shall show no signs of significant deterioration, such as crazing or cracking. They are then kept at room ambient conditions for not less than 16 h and not more than 96 h, after which they are tested according to the standard for the relevant test.

In order to evaluate the percentage retention of properties after test, samples that have not been conditioned according to Clause C.2 are tested at the same time as the conditioned samples.

The retention shall be as specified in Table C.1.

C.2 UV light conditioning test

C.2.1 Test apparatus

Samples are exposed to UV light by using one of the following apparatus:

- a twin enclosed carbon-arc (see C.2.3) with continuous exposure. The test apparatus shall operate with a black-panel temperature of $63\text{ °C} \pm 3\text{ °C}$; or*
- a xenon-arc (see C.2.4) with continuous exposure. The test apparatus shall operate with a 6 500 W, water-cooled xenon-arc lamp, a spectral irradiance of $0,35\text{ W/m}^2$ at 340 nm, a black-panel temperature of $63\text{ °C} \pm 3\text{ °C}$.*

C.2.2 Mounting of test samples

The samples are mounted vertically on the inside of the cylinder of the light exposure apparatus, with the widest portion of the samples facing the arcs. They are mounted so that they do not touch each other.

C.2.3 Carbon-arc light-exposure test

The apparatus described in ISO 4892-4, or equivalent, is used in accordance with the procedures given in ISO 4892-1 and ISO 4892-4 using a type 1 filter, without water spray.

NOTE The wording "without water spray" indicates that the samples are not sprayed with water during the test. Do not confuse water spray with water cooling that is necessary for operation of the apparatus.

Materials are exposed to the light continuously for a minimum of 720 h.

Materials tested with water spray are also considered acceptable.

C.2.4 Xenon-arc light-exposure test

The apparatus described in ISO 4892-2, or equivalent, is used in accordance with the procedures given in ISO 4892-1 and ISO 4892-4 using cycle 2 of method A of Table 3, without water spray.

NOTE The wording "without water spray" indicates that the samples are not sprayed with water during the test. Do not confuse water spray with water cooling that is necessary for operation of the apparatus.

Materials are exposed to the light continuously for a minimum of 1 000 h.

Materials tested with water spray are also considered acceptable.

Annex D (normative)

Test generators

D.1 Impulse test generators

These circuits produce test pulses as referenced in Table D.1. In this table:

- the circuit 1 impulse is typical of voltages induced into telephone wires and coaxial cables in long outdoor cable runs due to lightning strikes to their earthing shield;
- the circuit 2 impulse is typical of earth potential rises due to either lightning strikes to power lines or power line faults;
- the circuit 3 impulse is typical of voltages induced into antenna system wiring due to nearby lightning strikes to earth.

NOTE During the tests, use extreme care due to the high electric charge stored in the capacitor C_1 .

The circuit in Figure D.1, using the component values in circuits 1 and 2 of Table D.1, is used to generate impulses, the C_1 capacitor being charged initially to a voltage U_c .

Circuit 1 of Table D.1 generates 10/700 μs impulses (10 μs virtual front time, 700 μs virtual time to half value) to simulate transients in **external circuits** as indicated in Table 14, ID numbers 1, 2, 3, 4 and 5.

Circuit 2 of Table D.1 generates 1,2/50 μs impulses (1,2 μs virtual front time, 50 μs virtual time to half value) to simulate transients in power distribution systems.

The impulse wave shapes are under open-circuit conditions and can be different under load conditions.

*During the test, the peak voltage of the applied impulse shall not be less than the peak impulse test voltage (for example, see Table 15) and the pulse shape (for example, 1,2 μs virtual front time, 50 μs virtual time to half value for the 1,2/50 μs impulse) shall remain substantially the same as under open-circuit conditions. Components in parallel with the **clearance** may be disconnected during this test.*

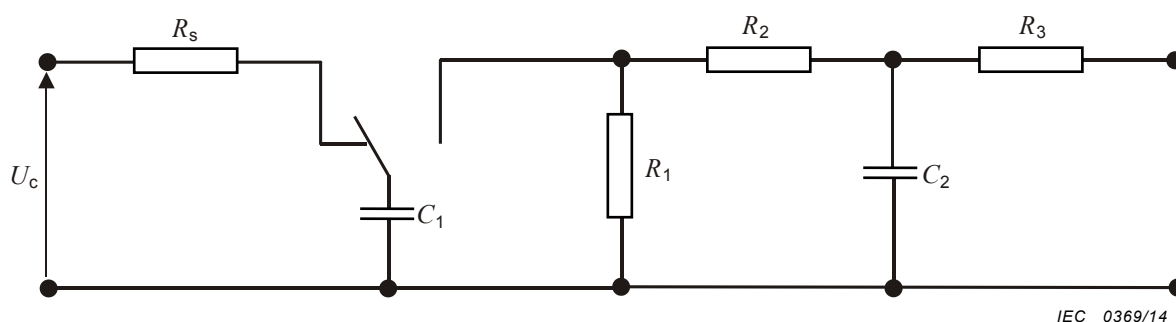

Figure D.1 – 1,2/50 μs and 10/700 μs voltage impulse generator

D.2 Antenna interface test generator

The circuit in Figure D.2 using the component values of circuit 3 in Table D.1, is used to generate impulses, the C_1 capacitor being charged initially to a voltage U_c .

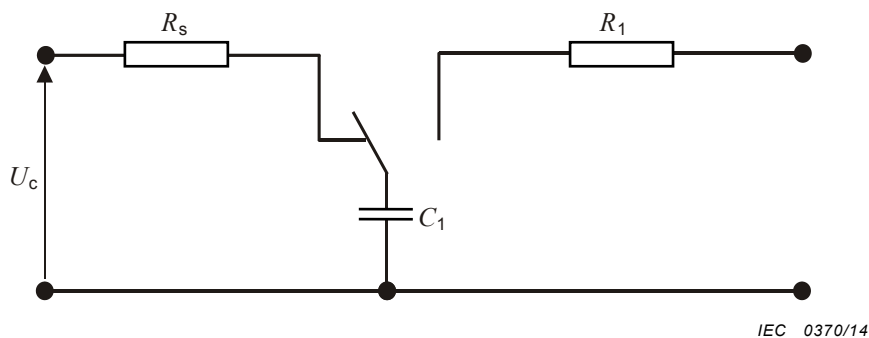

Figure D.2 – Antenna interface test generator circuit

Table D.1 – Component values for Figure D.1 and Figure D.2

	Test impulse	Figure	R_s	C_1	C_2	R_1	R_2	R_3
Circuit 1	10/700 μ s	D.1	-	20 μ F	0,2 μ F	50 Ω	15 Ω	25 Ω
Circuit 2	1,2/50 μ s	D.1	-	1 μ F	30 nF	76 Ω	13 Ω	25 Ω
Circuit 3	-	D.2	15 M Ω	1 nF	-	1 k Ω	-	-

Alternative test generators may be used provided they give the same result.
 NOTE Circuits 1 and 2 are based on ITU-T Recommendation K.44.

D.3 Electronic pulse generator

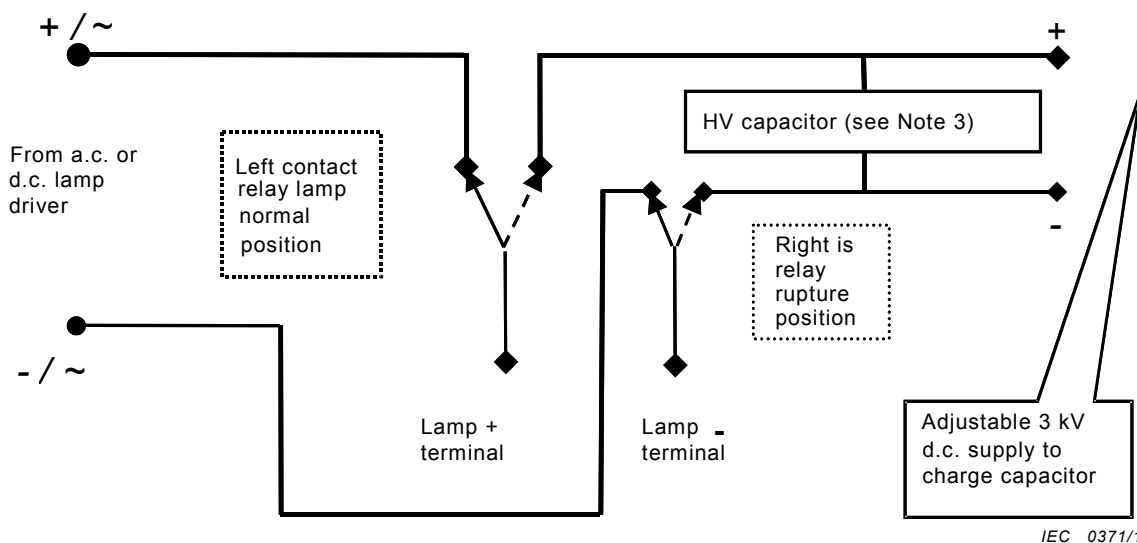

NOTE 1 The operating pressure of the lamp can be converted to energy (Joules). The operating energy level can typically be used as the starting point for the test charge.

NOTE 2 The relay is a 5 kV double pole defibrillator type, nitrogen filled. A defibrillator qualified relay is sufficient. See IEC 60601-2-4.

NOTE 3 The HV capacitor is rated 0,42 μ F 5 kV.

Figure D.3 – Example of an electronic pulse generator

Annex E (normative)

Test conditions for equipment containing audio amplifiers

E.1 Audio amplifier normal operating conditions

Equipment containing an audio amplifier shall be operated using a sine wave audio signal source at a frequency of 1 000 Hz. In the case where an amplifier is not intended for operation at 1 000 Hz, the **peak response frequency** shall be used.

The equipment shall be operated in such a way as to deliver 1/8 **non-clipped output power** to the **rated load impedance**. Alternatively, a band-limited pink noise signal may be used for operation after **non-clipped output power** is established using a sine wave. The noise bandwidth of the pink noise test signal shall be limited by a filter of a characteristic as shown in Figure E.1.

If visible clipping cannot be established, the maximum attainable power shall be considered as the **non-clipped output power**.

When classifying audio signals (see Table E.1), the equipment shall be operated to deliver maximum **non-clipped output power** into its **rated load impedance**. The load is removed and the electrical energy source class is determined from the resulting open-circuit output voltage.



Tone controls are to be set at mid-range.

In addition, all of the following conditions shall be considered under **normal operating conditions**:

- The most unfavourable **rated load impedance** or the actual loudspeaker, when provided, is connected to the amplifier output.
- All amplifier channels are operated simultaneously.
- Organs or similar instruments that have a tone-generator unit shall not be operated with the 1 000 Hz signal, but instead be operated with any combination of two bass pedal keys, if present, and ten manual keys depressed. All stops and tabs that can increase the output power shall be activated and the equipment shall be adjusted to deliver 1/8 of the maximum attainable output power.
- Where the intended amplifier function depends on phase difference between two channels, there shall be a phase difference of 90° between signals applied to the two channels.
- For equipment containing multi-channel amplifiers, where some channels cannot be operated independently, those channels shall be operated using the **rated load impedance** at the output power level that corresponds, by design, to 1/8 of the **non-clipped output power** of the adjustable amplifier channel(s).
- Where continuous operation is not possible, the amplifier shall be operated at the maximum output power level that allows continuous operation.

The temperature measurements shall be carried out with the equipment positioned in accordance with the instruction manual provided by the manufacturer, or, in the absence of instructions, the equipment shall be positioned 5 cm behind the front edge of an open-fronted wooden test box with 1 cm free space along the sides and top and 5 cm depth behind the equipment.

Table E.1 – Audio signal electrical energy source classes and safeguards

Class	Audio signal voltage V r.m.s.	Examples of safeguards between energy source and ordinary person	Example of safeguards between energy source and instructed person
ES1	0 up to 71	No safeguard necessary	No safeguard necessary
ES2	Above 71 and up to 120	Insulated terminals ^a marked with ISO 7000, symbol  0434a (2004-01) or symbol  0434b (2004-01)	No safeguard necessary
		Instructional safeguard for uninsulated parts of terminals and bare wiring ^b	
ES3	Above 120	Connectors conforming to the requirements of IEC 61984 and marked with the symbol of IEC 60417-6042 (2010-11) 	

^a Terminals that have no conductive parts **accessible** after wiring are installed according to instructions.

^b An **instructional safeguard** indicating that touching uninsulated terminals or wiring may result in an unpleasant sensation.

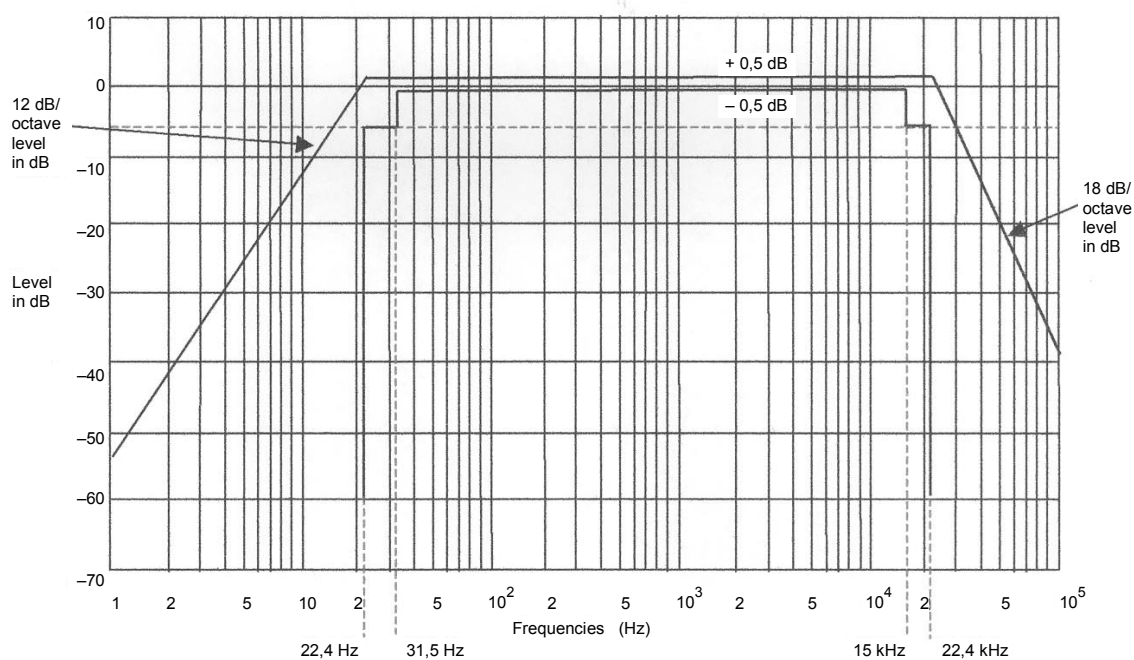

Figure E.1 – Band-pass filter for wide-band noise measurement

E.2 Audio amplifier abnormal operating conditions

Abnormal operating conditions shall be simulated by adjusting the controls to the most unfavourable output power from zero up to the maximum attainable output power into the most unfavourable **rated load impedance** connected to the output terminals. Short-circuit of the output terminals is also considered to be an **abnormal operating condition**.

Annex F (normative)

Equipment markings, instructions, and instructional safeguards

F.1 General

This annex specifies equipment markings, equipment instructions, and **instructional safeguards** necessary for equipment installation, operation, maintenance, and servicing in accordance with the requirements of this standard.

Unless symbols are used, safety related equipment marking, instructions and **instructional safeguards** shall be in a language accepted in the respective countries.

This annex does not apply to markings on components. Markings on components are specified in the relevant component standard.

This annex may apply to sub-assemblies such as power supplies.

NOTE 1 Where the term marking is used in this standard, it also applies to instructions and required elements of an **instructional safeguard**.

NOTE 2 See Table F.1 for examples of markings.

Care shall be taken so that additional markings and instructions not required by this standard do not contradict the markings and instructions required by this standard.

F.2 Letter symbols and graphical symbols

F.2.1 Letter symbols

Letter symbols for quantities and units shall be in accordance with IEC 60027-1.

F.2.2 Graphical symbols

Graphical symbols placed on the equipment, whether required by this standard or not, shall be in accordance with IEC 60417, ISO 3864-2, ISO 7000 or ISO 7010, if available. In the absence of suitable symbols, the manufacturer may design specific graphical symbols.

F.2.3 Compliance criteria

Compliance is checked by inspection.

F.3 Equipment markings

F.3.1 Equipment marking locations

In general, equipment markings shall be located near or adjacent to the part or region that is the subject of the marking.

Equipment markings specified in F.3.2, F.3.3, F.3.6 and F.3.7 shall be on the exterior of the equipment, excluding the bottom. However, these markings may be in an area that is easily **accessible** by hand, for example:

– under a lid, or

- on the exterior of the bottom of
 - **direct plug-in equipment, hand-held equipment, transportable equipment**, or
 - **movable equipment** with a mass not exceeding 18 kg, provided that the location of the marking is given in the instructions.

Markings shall not be put on parts that can be removed without the use of a **tool**, unless they apply to this part.

For **permanently connected equipment**, installation instructions shall be provided either as markings on the equipment, or in the instructions, or in a separate installation instruction document.

For rack or panel mounted equipment exceeding 18 kg, markings may be on any surface that becomes visible after removal of the equipment from the rack or panel.

Unless the meaning of the marking is obvious, the marking shall be explained in the instructions.

Compliance is checked by inspection.

F.3.2 Equipment identification markings

F.3.2.1 Manufacturer identification

The manufacturer or responsible vendor shall be identified by means of a marking on the equipment. Identification may be the manufacturer's name, the responsible vendor's name, trademark, or other equivalent identification.

Compliance is checked by inspection.

F.3.2.2 Model identification

The model number, model name, or equivalent shall be identified by means of a marking on the equipment.

Compliance is checked by inspection.

F.3.3 Equipment rating markings

F.3.3.1 Equipment with direct connection to mains

If a unit is provided with a means for direct connection to the **mains**, it shall be marked with an electrical rating, as specified in F.3.3.3 to F.3.3.6.

F.3.3.2 Equipment without direct connection to mains

If a unit is not provided with a means for direct connection to the **mains**, it need not be marked with any electrical rating. However, any **rated power** or **rated current** marking on the equipment shall comply with B.2.5.

F.3.3.3 Nature of the supply voltage

The nature of the supply voltage, d.c., a.c., or three-phase a.c., shall be marked on the equipment and shall immediately follow the equipment voltage rating. If a symbol is used to identify a.c. or d.c., the symbol \sim , IEC 60417-5032 (2002-10), shall be used for a.c. and the symbol --- , IEC 60417-5031 (2002-10), shall be used for d.c.

Three-phase equipment may be identified with “3-phase” or “3Ø” or any other arrangement that clearly indicates the phase of the supply voltage of the equipment.

F.3.3.4 Rated voltage

The **rated voltage** of the equipment shall be marked on the equipment. The voltage rating marking shall be immediately followed by the nature of the supply marking.

The **rated voltage** may be:

- a single, nominal value, or
- a single nominal value and a tolerance percentage of the nominal value, or
- two or more nominal values separated by a solidus (/), or
- a range indicated by minimum and maximum values separated by a hyphen, or
- any other arrangement that clearly indicates the voltage of the equipment.

If the equipment has more than one nominal voltage, all such voltages may be marked on the equipment. However, the voltage for which the equipment is set shall be clearly indicated (see F.3.4).

Three-phase equipment shall be marked with the phase-to-phase voltage, a symbol indicating power supply system in accordance with IEC 61293, a solidus (/), the phase-to-neutral voltage, the symbol for voltage (V) and the number of phases, in that order. Any other arrangement that clearly indicates the three-phase **rated voltage** of the equipment is also acceptable.

NOTE The solidus (/) represents the word “or” and the hyphen (-) represents the word “to”.

F.3.3.5 Rated frequency

The **rated frequency** of the equipment shall be marked on the equipment.

The **rated frequency** may be:

- a single, nominal value, or
- a single nominal value and a tolerance percentage of the nominal value, or
- two or more nominal values separated by a solidus (/), or
- a range indicated by minimum and maximum values separated by a hyphen, or
- any other arrangement that clearly indicates the **rated frequency** of the equipment.

F.3.3.6 Rated current or rated power

The **rated current** or **rated power** of the equipment shall be marked on the equipment.

For three-phase equipment, the **rated current** or **rated power** is the current or power of one phase.

NOTE 1 B.2.5 establishes criteria for the way in which **rated current** or **rated power** are measured.

NOTE 2 The **rated current** or **rated power** need not be stated to more than one significant digit.

NOTE 3 In some countries, for markings on equipment, a period is required as the decimal designator.

If the equipment has a socket-outlet for providing **mains** power to other equipment, the **rated current** or **rated power** of the equipment shall include the assigned current or power of the socket-outlet.

See F.3.5.1 for marking requirements for a **mains** socket-outlet.

If the equipment has more than one **rated voltage**, the **rated current** or **rated power** for each **rated voltage** shall be marked on the equipment. The arrangement of the markings shall clearly indicate the **rated current** or **rated power** associated with each **rated voltage** of the equipment.

F.3.3.7 Equipment with multiple supply connections

If the equipment has multiple supply connections, each connection shall be marked with its **rated current** or **rated power**.

If the equipment has multiple supply connections, and if each connection has a different **rated voltage** than the other supply connections, each connection shall be marked with its **rated voltage**.

The overall system electrical rating need not be marked.

F.3.3.8 Compliance criteria

Compliance is checked by inspection.

F.3.4 Voltage setting device

If the equipment uses a voltage setting device that is operable by an **ordinary person** or an **instructed person**, the act of changing the voltage setting shall also change the indication of the voltage for which the equipment is set. The setting shall be readily discernable when the equipment is ready for use.

If the equipment uses a voltage-setting device that is operable only by a **skilled person**, and if the act of changing the voltage setting does not also change the indication of the voltage rating, an **instructional safeguard** shall state that, when changing the voltage setting, the indication of the voltage setting shall also be changed.

Compliance is checked by inspection.

F.3.5 Markings on terminals and operating devices

F.3.5.1 Mains appliance outlet and socket-outlet markings

If a **mains** appliance outlet in accordance with IEC 60320-2-2 is provided on the equipment, the **rated voltage** and assigned current or power shall be marked adjacent to the appliance outlet.

If the **mains** socket-outlet is configured in accordance with IEC/TR 60083 or a relevant national standard, the assigned current or power shall be marked. If the voltage of the socket-outlet is the same as the **mains** voltage, the voltage need not be marked.

F.3.5.2 Switch position identification marking

The position of a disconnect switch or circuit-breaker shall be identified. Such identification may be comprised of words, symbols, or an indicator.

If a symbol is used, the symbol shall be in accordance with IEC 60417.

F.3.5.3 Replacement fuse identification and rating markings

If a fuse is replaceable by an **ordinary person** or an **instructed person**, identification of a suitable replacement fuse shall be marked adjacent to the fuseholder. Identification shall include the fuse current rating and the following as appropriate:

- if the fuse needs a special breaking capacity which is necessary for the **safeguard** function, the appropriate symbol that indicates the breaking capacity;
- if the fuse can be replaced with a fuse of a different voltage rating, the fuse voltage rating;
- if the fuse is a time-delay fuse, and the time-delay is necessary for the **safeguard** function, the appropriate symbol that indicates the time-delay.

If a fuse is replaceable by an **ordinary person**, the codings of the relevant fuses shall be explained in the user instructions.

If a fuse is not replaceable by an **ordinary person** or an **instructed person**:

- identification of a suitable replacement fuse shall be marked adjacent to the fuse or shall be provided in the service instructions;
- if the fuse is, or could be, in the neutral of the **mains** supply, an **instructional safeguard** shall state that the fuse is in the neutral, and that the **mains** shall be disconnected to de-energize the phase conductors.

If a fuse is not intended to be replaceable, fuse ratings need not be marked.

F.3.5.4 Replacement battery identification marking

If a **battery** can be replaced by an incorrect type of replaceable **battery**, an **instructional safeguard** shall be provided in accordance with Clause F.5

F.3.5.5 Terminal marking location

The terminal markings specified in F.3.6.1 and F.3.6.2.2 shall not be placed on screws, removable washers, or other parts that can be removed when conductors are being connected.

F.3.5.6 Compliance criteria



Compliance is checked by inspection.

F.3.6 Equipment markings related to equipment classification

F.3.6.1 Class I equipment

F.3.6.1.1 Protective earthing conductor terminal

The terminal intended for connection of **class I equipment** to the installation **protective earthing conductor** shall be identified with the symbol , IEC 60417-5019 (2006-08).

A terminal intended for connection of a class I sub-assembly (for example, a power supply), or a component (for example, a terminal block) to the equipment **protective earthing conductor** may be identified with either symbol , IEC 60417-5019 (2006-08), or with symbol , IEC 60417-5017 (2006-08).

F.3.6.1.2 Neutral conductor terminal

For **permanently connected equipment**, the terminal, if any, intended exclusively for connection of the **mains** neutral conductor shall be identified by the capital letter “N”.

F.3.6.1.3 Protective bonding conductor terminals

Terminals for **protective bonding conductors** need not be identified.

If such terminals are identified, they shall be marked with the earth symbol \perp , IEC 60417-5017 (2006-08). However, a component terminal or a terminal for bonding wiring from the appliance inlet already marked with the symbol \oplus , IEC 60417-5019 (2006-08), is acceptable as identification of a **protective bonding conductor** terminal.

F.3.6.2 Class II equipment

F.3.6.2.1 Equipment class marking

Class II equipment without **functional earth** connection shall bear the symbol , IEC 60417-5172 (2003-02).

Class II equipment with **functional earth** connection shall bear the symbol , IEC 60417-6092 (2011-10).

The above symbols shall not be used for **class I equipment**.

Equipment providing protective earthing to other equipment cannot be regarded as **class II equipment**.

For **class II equipment** provided with a **mains** cord having a conductor with green-and-yellow insulation that is used only to provide a connection to **functional earth**, there are no requirements other than those in 4.6 regarding the termination of this conductor at the equipment end.

F.3.6.2.2 Functional earth terminal marking

Wiring terminals to be used only for the connection of **functional earth** shall be marked with the symbol , IEC 60417-5020 (2002-10). These terminals shall not be marked with the symbol \perp , IEC 60417-5017 (2006-08) or with the symbol \oplus , IEC 60417-5019 (2006-08).

However, these symbols may be used for a wiring terminal provided on a component (for example, a terminal block) or subassembly.

F.3.6.3 Compliance criteria

Compliance is checked by inspection.

F.3.7 Equipment IP rating marking

If the equipment is intended for other than IPX0, the equipment shall bear the IP number according to the degree of protection against ingress of water in accordance with IEC 60529.

Compliance is checked by inspection.

F.3.8 External power supply output marking

The d.c. output of an external power supply shall be marked with the voltage rating, the current rating and the polarity.

The a.c. output of an external power supply shall be marked with the voltage rating, the current rating and the frequency if it is different from the input frequency.

Compliance is checked by inspection and measurement.

F.3.9 Durability, legibility and permanence of markings

In general, all markings required to be on the equipment shall be durable and legible, and shall be easily discernable under normal lighting conditions.

Unless otherwise specified, **instructional safeguards** do not have to be in colour. If an **instructional safeguard** is in colour, the colour shall be in accordance with the ISO 3864 series. Markings that are engraved or moulded need not be in contrasting colours provided that they are legible and readily discernable under normal lighting conditions.

Printed or screened markings shall also be permanent.

Compliance is checked by inspection. Permanency is determined by the tests of F.3.10.

F.3.10 Test for the permanence of markings

F.3.10.1 General

Each required printed or screened marking shall be tested. However, if the data sheet for a label confirms compliance with the test requirements, the test need not be performed.

F.3.10.2 Testing procedure

The test is conducted by rubbing the marking by hand without appreciable force for 15 s with a piece of cloth soaked with water and at a different place or on a different sample for 15 s with a piece of cloth soaked with the petroleum spirit specified in F.3.10.3.

F.3.10.3 Petroleum spirit

Petroleum spirit is a reagent grade hexane with a minimum of 85 % n-hexane.

NOTE The designation "n-hexane" is chemical nomenclature for a "normal" or straight chain hydrocarbon. This petroleum spirit is further identified as a certified ACS (American Chemical Society) reagent grade hexane (CAS# 110-54-3).

F.3.10.4 Compliance criteria

After each test, the marking shall remain legible. If the marking is on a separable label, the label shall show no curling and shall not be removable by hand.

F.4 Instructions

When information with regard to safety is required according to this standard, this information shall be given in an instruction for installation or instruction for initial use. This information shall be available prior to installation and initial use of the equipment.

Equipment for use in locations where children are not likely to be present and that is evaluated using the jointed test probe of Figure V.2 shall have the following or equivalent statement in the user instructions.

NOTE 1 This equipment design typically applies to commercial or industrial equipment expected to be installed in locations where only adults are normally present.

This equipment is not suitable for use in locations where children are likely to be present.

NOTE 2 See also ISO/IEC Guide 37, instructions for use of products of consumer interest.

The instructions shall include the following as far as applicable.

- Instructions to ensure correct and safe installation and interconnection of the equipment.
- For equipment intended only for use in a **restricted access area**, the instructions shall so state.
- If the equipment is intended to be fastened in place, the instructions shall explain how to securely fasten the equipment.
- For audio equipment with terminals classified as ES3 in accordance with Table E.1, and for other equipment with terminals marked in accordance with F.3.6.1, the instructions shall require that the external wiring connected to these terminals shall be installed by a **skilled person**, or shall be connected by means of ready-made leads or cords that are constructed in a way that would prevent contact with any ES3 circuit.
- If protective earthing is used as a **safeguard**, the instructions shall require connection of the equipment **protective earthing conductor** to the installation **protective earthing conductor** (for example, by means of a power cord connected to a socket-outlet with earthing connection).
- For equipment with **protective conductor current** on the **protective earthing conductor** exceeding the ES2 limits of 5.2.2.2, the equipment shall bear an **instructional safeguard** in accordance with 5.7.5.
- Graphical symbols placed on the equipment and used as an **instructional safeguard** shall be explained.
- If a **permanently connected equipment** is not provided with an all-pole **mains** switch, the instructions for installation shall state that an all-pole **mains** switch in accordance with Annex L shall be incorporated in the electrical installation of the building.
- If a replaceable component or module provides a **safeguard** function, identification of a suitable replacement component or module shall be provided in the **ordinary person** instructions or **instructed person** instructions, or **skilled person** instructions, as applicable.

Compliance is checked by inspection.

F.5 Instructional safeguards

Unless otherwise specified in this standard, an **instructional safeguard** is comprised of element 1a or element 2, or both, together with element 3 and element 4. If a suitable symbol for element 1a is not available, then element 1b may be used instead.



Unless otherwise specified in this standard, the location of the **instructional safeguard** shall be as follows:

- the complete **instructional safeguard** shall be marked on the equipment, or
- element 1a or element 2, or both, shall be marked on the equipment and the complete **instructional safeguard** shall be in the text of an accompanying document. If only element 2 is used, the text shall be preceded by the word “Warning” or “Caution” or similar wording.

Any **instructional safeguard** element placed on the equipment shall be visible to the person prior to potential exposure to the class 2 energy source or class 3 energy source parts and as close as reasonably possible to the energy source parts.

Elements 1a, 1b, 2, 3, and 4 are specified in Table F.1.

Table F.1 – Instructional safeguard element description and examples

Element	Description	Example
1a	A symbol that identifies the nature of the class 2 or class 3 energy source or the consequences that can be caused by the class 2 or class 3 energy source.	
1b	A symbol such as ISO 7000-0434 (2004-01) or a combination of this symbol and ISO 7000-1641 (2004-01) to refer to text in an accompanying document. These symbols may be combined.	
2	Text that identifies the nature of the class 2 or class 3 energy source or the consequences that can be caused by the energy source, and the location of the energy source.	Hot parts!
3	Text that describes the possible consequences of energy transfer from the energy source to a body part.	Burned fingers when handling the parts
4	Text that describes the safeguard action necessary to avoid energy transfer to a body part.	Wait one-half hour after switching off before handling parts
The symbols for elements 1a and 1b shall be from IEC 60417, ISO 3864-2, ISO 7000, ISO 7010 or the equivalent.		

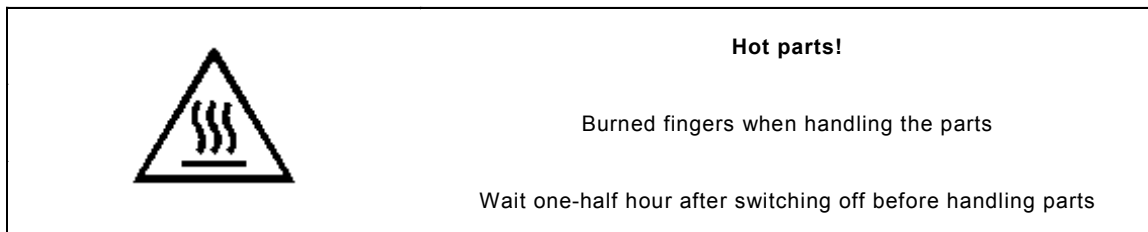

IEC 0373/14

Figure F.1 illustrates one example of the arrangement of the four elements that comprise a complete **instructional safeguard**. Other arrangements in the positioning of the elements are also acceptable.

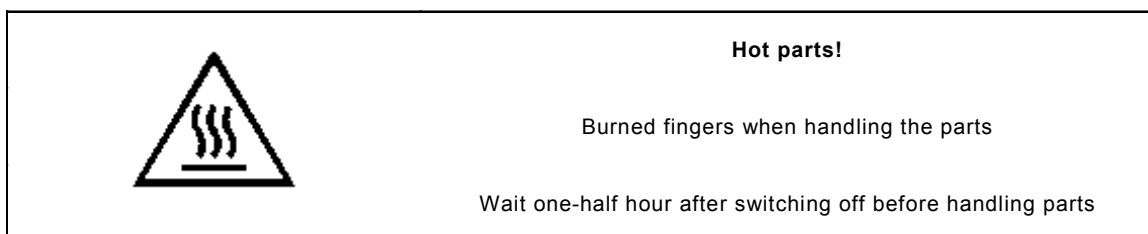













IEC 0373/14

Figure F.1 – Example of an instructional safeguard

See Table F.2 for examples of markings, instructions, and **instructional safeguards**.

Table F.2 – Examples of markings, instructions, and instructional safeguards

Rating	Example
Rated d.c. voltage	48 V d.c. 48 V 
Rated a.c. voltage	230 V  230 V  ±10 % 100/120/220/240 V a.c. 100–250 V a.c.
Rated 3-phase voltage	400 Y/230 V 3Ø 208 Y/120 V 3-phase 208 Y/120 V 3 
Rated frequency	50-60 Hz 50/60 Hz
Rated current	1 A
Instruction	Example
Positioning of cell, IEC 60417-5002 (2002-10)	
AC, IEC 60417-5032 (2002-10)	
DC, IEC 60417-5031 (2002-10)	
Class II equipment, IEC 60417-5172 (2003-02)	
Caution, ISO 7000, 0434a or 0434b (2004-01)	
Dangerous voltage, IEC 60417-5036 (2002-10)	
Earth; ground, IEC 60417-5017 (2006-08)	
Protective earth; protective ground, IEC 60417-5019 (2006-08)	

Annex G (normative)

Components

G.1 Switches

G.1.1 General

Requirements for switches that are located in PS3 are specified below.

A switch may be tested separately or in the equipment.

G.1.2 Requirements

Switches used as **disconnect devices** shall comply with the requirements in Annex L.

A switch shall not be fitted in a **mains** supply cord.

A switch shall comply with all of the following:

- comply with the requirements of IEC 61058-1:2008, whereby the following applies:
 - 10 000 operating cycles (see 7.1.4.4 of IEC 61058-1:2008);
 - the switch shall be suitable for use in the **pollution degree** environment in which it is used, typically a **pollution degree** 2 environment (see 7.1.6.2 of IEC 61058-1:2008);
 - the switch have a glow wire temperature of 850 °C (see 7.1.9.3 of IEC 61058-1:2008);
 - for **mains** switches used in CRT televisions, the speed of contact making and breaking shall be independent of the speed of actuation;

NOTE This is because there is a high inrush current due to the degaussing coil.

- the characteristics of the switch with regard to the ratings and classification (see IEC 61058-1) shall be appropriate for the function of the switch under **normal operating conditions** as given below:
 - the ratings of the switch (see Clause 6 of IEC 61058-1:2008);
 - the classification of the switch according to:
 - nature of supply (see 7.1.1 of IEC 61058-1:2008);
 - type of load to be controlled by the switch (see 7.1.2 of IEC 61058-1:2008);
 - ambient air temperature (see 7.1.3 of IEC 61058-1:2008);
- Compliance is checked according to IEC 61058-1:2008.*
- the switch shall be so constructed that it does not attain excessive temperatures under **normal operating conditions**;

Compliance is checked in the on-position according to 16.2.2 d), l) and m) of IEC 61058-1:2008, except the current is the sum of the equipment current and the maximum current supplied to other equipment, if any.

- a **mains** switch controlling connectors supplying power to other equipment shall withstand the electrical endurance test according to 17.2 of IEC 61058-1:2008, with an additional load according to Figure 9 of IEC 61058-1:2008. The total current rating of the additional load shall correspond to the marking of the connectors supplying power to other equipment. The peak surge current of the additional load shall have a value as shown in Table G.1.

Table G.1 – Peak surge current

Current rating A	Peak surge current A
up to and including 0,5	20
up to and including 1,0	50
up to and including 2,5	100
over 2,5	150

G.1.3 Test method and compliance criteria

The tests of IEC 61058-1:2008 shall be applied with the modifications shown in G.1.2.

After the tests, the switch shall show no deterioration of its **enclosure** and no loosening of electrical connections or mechanical fixings.

G.2 Relays**G.2.1 Requirements**

The requirements for relays that are located in a PS3 circuit are specified below.

A relay may be tested separately or in the equipment.

For resistance to heat and fire, see Clause 16 in IEC 61810-1:2008.

A relay shall comply with the requirements of IEC 61810-1:2008, taking into account the following:

- materials shall comply with 6.4.5.2 or pass a glow wire test at 750 °C or a needle flame test;
- 10 000 operating cycles for endurance (see 5.5 of IEC 61810-1:2008) and during the electric endurance test (see Clause 11 of IEC 61810-1:2008), no temporary malfunction shall occur;

NOTE A temporary malfunction is an event that has to be eliminated during the test at latest after one additional energization cycle without any external influence (see Clause 11 of IEC 61810-1:2008).

- the relay shall be suitable for use in the applicable pollution situation (see Clause 13 of IEC 61810-1:2008);
- for **mains** relays the speed of contact making and breaking shall be independent of the rate of rise of the coil voltage;
- characteristics of the relay with regard to the ratings and classification (see IEC 61810-1), shall be appropriate for the function of the relay under **normal operating condition** as given below:
 - rated coil voltage and rated coil voltage range (see 5.1 of IEC 61810-1:2008);
 - rated contact load and the type of load (see 5.7 of IEC 61810-1:2008);
 - release voltage (see 5.3 of IEC 61810-1:2008);
 - the ambient air temperature and upper and lower limit of the temperature (see 5.8 of IEC 61810-1:2008);
 - only relay technology category RT IV and RT V shall be considered to meet **pollution degree** 1 environment, for example, the relay meets 5.4.8 of this standard (see 5.9 of IEC 61810-1:2008);
- electric strength (see 10.3 of IEC 61810-1:2008), except the test voltage shall be the required test voltage specified in 5.4.9.1 of this standard;

- if the **required withstand voltage** (referred to as impulse withstand voltage in IEC 61810-1) exceeds 12 kV, **clearances** shall comply with Table 15 of this standard;
- if the **r.m.s. working voltage** (referred to as voltage r.m.s. in IEC 61810-1) exceeds 500 V, **creepage distances** shall comply with Table 18 of this standard;
- **solid insulation** in accordance with 13.3 of IEC 61810-1:2008 or with 5.4.4 of this standard.

Compliance is checked according to IEC 61810-1 and the requirements of this standard.

G.2.2 Overload test

A relay shall withstand the following test.

The contact of the relay is subjected to an overload test consisting of 50 cycles of operation at the rate of 6 to 10 cycles per minute, making and breaking 150 % of the current imposed in the application, except that where a contact switches a motor load, the test is conducted with the rotor of the motor in a locked condition. After the test, the relay shall still be functional.

G.2.3 Relay controlling connectors supplying power to other equipment

*A **mains** relay controlling connectors supplying power to other equipment shall withstand the endurance test of Clause 11 of IEC 61810-1:2008, with an additional load that is equal to the total marked load of the connectors supplying power to other equipment.*

G.2.4 Test method and compliance criteria

*For **mains** relays, the tests of IEC 61810-1 and this standard shall be applied with the modifications shown in Clause G.2 of this standard.*

*After the tests, the relay shall show no deterioration of its **enclosure**, no reduction of **clearances** and **creepage distances** and no loosening of electrical connections or mechanical fixings.*

G.3 Protective devices

G.3.1 Thermal cut-offs

G.3.1.1 Requirements

A **thermal cut-off** used as a **safeguard** shall comply with requirements a) and b), or c).

NOTE In IEC 60730-1, a “thermal cut-off” is a “thermal cut-out”.

a) The **thermal cut-off**, when tested as a separate component, shall comply with the requirements and tests of the IEC 60730 series as far as applicable:

- the **thermal cut-off** shall be of Type 2 action (see 6.4.2 of IEC 60730-1:2010);
- the **thermal cut-off** shall have at least micro-disconnection, Type 2B (see 6.4.3.2 and 6.9.2 of IEC 60730-1:2010);
- the **thermal cut-off** shall have a trip-free mechanism in which contacts cannot be prevented from opening against a continuation of a fault, Type 2E (see 6.4.3.5 of IEC 60730-1:2010);
- the number of cycles of automatic action shall be at least:
 - 3 000 cycles for a **thermal cut-off** with automatic reset used in circuits that are not switched off when the equipment is switched off (see 6.11.8 of IEC 60730-1:2010),
 - 300 cycles for a **thermal cut-off** with automatic reset used in circuits that are switched off together with apparatus and for **thermal cut-off** with no automatic

reset that can be reset by hand from the outside of the equipment (see 6.11.10 of IEC 60730-1:2010),

- 30 cycles for a **thermal cut-off** with no automatic reset and that cannot be reset by hand from the outside of the equipment (see 6.11.11 of IEC 60730-1:2010);
- the **thermal cut-off** shall be tested as designed for a long period of electrical stress across insulating parts (see 6.14.2 of IEC 60730-1:2010);
- the **thermal cut-off** shall meet the conditioning requirements for an intended use of at least 10 000 h (see 6.16.3 of IEC 60730-1:2010);
- the contact gap, and the distance between the terminations and connecting leads of the contacts, shall comply with 13.1.4 and 13.2 of IEC 60730-1:2010.

b) The characteristics of the **thermal cut-off** with regard to

- the ratings of the **thermal cut-off** (see Clause 5 of IEC 60730-1:2010);
- the classification of the **thermal cut-off** according to the:
 - nature of supply (see 6.1 of IEC 60730-1:2010),
 - type of load to be controlled (see 6.2 of IEC 60730-1:2010),
 - degree of protection provided by **enclosures** against ingress of solid objects and dust (see 6.5.1 of IEC 60730-1:2010),
 - degree of protection provided by **enclosures** against harmful ingress of water (see 6.5.2 of IEC 60730-1:2010),
 - pollution situation for which the **thermal cut-off** is suitable (see 6.5.3 of IEC 60730-1:2010),
 - maximum ambient temperature limit (see 6.7 of IEC 60730-1:2010);

shall be appropriate for the application in the equipment.

c) The **thermal cut-off** when tested as a part of the equipment shall:

- have at least micro-disconnection according to IEC 60730-1 withstanding a test voltage according to 13.2 of IEC 60730-1:2010; and
- have a trip-free mechanism in which contacts cannot be prevented from opening against a continuation of a fault; and
- be conditioned for 300 h when the equipment is operated under **normal operating conditions** at an ambient temperature of 30 °C or at the maximum ambient temperature specified by the manufacturer, whichever is higher; and
- be subjected to a number of cycles of automatic action as specified under a) for a **thermal cut-off** tested as a separate component, by estimating the relevant fault conditions.

G.3.1.2 Test method and compliance criteria

*The **thermal cut-off** is checked according to the test specifications of IEC 60730 series by inspection and by measurement. The test is made on three specimens.*

*During the test, no sustained arcing shall occur. After the test, the **thermal cut-off** shall show no loosening of electrical connections or mechanical fixings.*

G.3.2 Thermal links

G.3.2.1 Requirements

A thermal link used as a **safeguard** shall meet either requirement a) or b) below.

- a) The thermal link when tested as a separate component, shall comply with the requirements of IEC 60691.

The characteristics of the thermal link with regard to

- the ambient conditions (see Clause 5 of IEC 60691:2002);
- the electrical conditions (see 6.1 of IEC 60691:2002);
- the thermal conditions (see 6.2 of IEC 60691:2002);
- the rating of the thermal link (see Clause 8 b) of IEC 60691:2002);
- the suitability for sealing in, or use with impregnating fluids or cleaning solvents (see Clause 8 c) of IEC 60691:2002),

shall be appropriate for the application in the equipment under **normal operating conditions** and under **single fault conditions**.

The electric strength of the thermal link shall meet the requirements of 5.4.9.1 of this standard except across the disconnection (contact parts) and except between terminations and connecting leads of the contacts, for which 10.3 of IEC 60691:2002 applies.

b) The thermal link when tested as a part of the equipment shall be:

- aged for 300 h at a temperature corresponding to the ambient temperature of the thermal link when the equipment is operated under **normal operating conditions** at an ambient temperature of 30 °C or at the maximum ambient temperature specified by the manufacturer, whichever is higher; and
- subjected to such **single fault conditions** of the equipment that cause the thermal link to operate. During the test, no sustained arcing shall occur; and
- capable of withstanding two times the voltage across the disconnection and have an insulation resistance of at least 0,2 MΩ, when measured with a voltage equal to two times the voltage across the disconnection.

G.3.2.2 Test method and compliance criteria

If a thermal link is tested as a separate component according to G.3.2.1 a) above, compliance is checked according to the test specifications of IEC 60691, by inspection and measurement.

If a thermal link is tested as a part of the equipment according to G.3.2.1 b) above, compliance is checked by inspection and by the specified tests in the given order. The test is carried out three times. The thermal link is replaced partially or completely after each test.

When the thermal link cannot be replaced partially or completely, the complete component part including the thermal link (for example, a transformer) should be replaced.

No failure is allowed.

G.3.3 PTC thermistors

PTC thermistors used as **safeguards** shall comply with Clauses 15, 17, J.15 and J.17 of IEC 60730-1:2010.

For PTC thermistors:

- whose continuous power dissipation that appears at its maximum voltage at an ambient temperature of 25 °C or otherwise specified by the manufacturer for tripped state, determined as given in 3.38 of IEC 60738-1:2009, exceeds 15 W; and
- with a size of 1 750 mm³ or more; and
- located in a PS2 or PS3 circuit;

the encapsulation or tubing shall be made of **V-1 class material** or equivalent material.

NOTE Tripped state means the state in which PTC thermistors are shifted to a high resistance condition at a given temperature.

Compliance is checked by inspection.

G.3.4 Overcurrent protective devices

Except for devices covered by G.3.5, overcurrent protective devices used as a **safeguard** shall comply with their applicable IEC standards.

Compliance is checked by inspection.

G.3.5 Safeguard components not mentioned in G.3.1 to G.3.4

G.3.5.1 Requirements

Such protective devices (for example, fusing resistors, fuse-links not standardized in IEC 60127 series or miniature circuit breakers) shall have adequate rating including breaking capacity.

For non-resettable protective devices, such as fuse-links, a marking shall be located close to the protective device, so that correct replacement is possible.

G.3.5.2 Test method and compliance criteria

*Compliance is checked by inspection and by performing **single fault condition** testing as specified in Clause B.4.*

The test is carried out three times. No failure is allowed.

G.4 Connectors

G.4.1 Clearance and creepage distance requirements

The **clearance** and **creepage distance** between the outer insulating surface of a connector (including an opening in the **enclosure**) and conductive parts that are connected to ES2 within the connector (or in the **enclosure**) shall comply with the requirements for **basic insulation**.

The **clearance** and **creepage distance** between the outer insulating surface of a connector (including an opening in the **enclosure**) and conductive parts that are connected to ES3 within the connector (or in the **enclosure**) shall comply with the requirements for **reinforced insulation**. As an exception, the **clearance** and **creepage distance** may comply with the requirements for **basic insulation** if the connector is:

- fixed to the equipment; and
- located internally to the outer **electrical enclosure** of the equipment; and
- only **accessible** after removal of a subassembly that
 - is required to be in place during **normal operating conditions**, and
 - is provided with an **instructional safeguard** to replace the removed subassembly.

The tests of 5.3.2 apply to such connectors after removal of the subassembly.

G.4.2 Mains connectors

Mains connectors that are listed in IEC/TR 60083 or that comply with one of the following standards IEC 60309 series, IEC 60320 series, IEC 60906-1 or IEC 60906-2, are considered acceptable without further evaluation.

G.4.3 Connectors other than mains connectors

Connectors other than for connecting **mains** power shall be so designed that the plug has such a shape that insertion into a **mains** socket-outlet or appliance coupler is unlikely to occur.

EXAMPLE Connectors meeting this requirement are those constructed as described in IEC 60130-2, IEC 60130-9, IEC 60169-3 or IEC 60906-3. An example of a connector not meeting the requirements of this subclause is the so-called "banana" plug. Standard 3,5 mm audio plugs are not considered likely to be put in the **mains** socket outlet.

Compliance is checked by inspection.

G.5 Wound components

G.5.1 Wire insulation in wound components

G.5.1.1 General

This clause applies to wound components comprising **basic insulation**, **supplementary insulation** or **reinforced insulation**.

G.5.1.2 Protection against mechanical stress

Where two winding wires, or one winding wire and another wire, are in contact inside the wound component, crossing each other at an angle between 45° and 90° and subject to winding tension, one of the following applies:

- protection against mechanical stress shall be provided. For example, this protection can be achieved by providing physical separation in the form of insulating sleeving or sheet material, or by using double the required number of insulation layers on the winding wire; or
- the wound component passes the endurance tests of G.5.2.

Additionally, if the above construction provides **basic insulation**, **supplementary insulation** or **reinforced insulation**, the finished wound component shall pass a **routine test** for electric strength in accordance with 5.4.9.1.

G.5.1.3 Test method and compliance criteria

Compliance is checked by 5.4.4.1 and, where required, by G.5.2. If the tests of Annex J are required, they are not repeated if the material data sheets confirm compliance.

G.5.2 Endurance test

G.5.2.1 General test requirements

Where required by G.5.1.2, three samples of the wound component are subjected to 10 test cycles as follows:

- *The samples are subjected to the heat run test of G.5.2.2. After the test, the samples are allowed to cool down to ambient temperature.*
- *The samples are then subjected to the vibration test of G.15.3.4.*
- *The samples are then subjected for two days to the humidity conditioning of 5.4.8.*

The tests described below are made before the start of the 10 cycles and after each cycle.

The electric strength test of 5.4.9.1 is carried out.

After the electric strength test, the test of G.5.2.3 is made on wound components that are supplied from the **mains**, except for switching mode power supply.

G.5.2.2 Heat run test

Depending on the type thermal classification of the insulation, the specimens are kept in a heating cabinet for a combination of time and temperature as specified in Table G.2. The 10 cycles are carried out with the same combination.

The temperature in the heating cabinet shall be maintained within a tolerance of $\pm 5^\circ\text{C}$.

Table G.2 – Test temperature and testing time (days) per cycle

Thermal classification	Class 105 (A)	Class 120 (E)	Class 130 (B)	Class 155 (F)	Class 180 (H)	Class 200 (N)	Class 220 (R)	Class 250 -
Test temperature °C	Testing time duration for the test of G.5.2							
290								4 days
280								7 days
270								14 days
260							4 days	
250							7 days	
240						4 days	14 days	
230						7 days		
220					4 days	14 days		
210					7 days			
200					14 days			
190				4 days				
180				7 days				
170				14 days				
160			4 days					
150		4 days	7 days					
140		7 days						
130	4 days							
120	7 days							
The classes are related to the classification of electrical insulating materials and EIS in accordance with IEC 60085. The assigned letter designations are given in parentheses.								
The manufacturer shall specify the test duration or the test temperature.								

G.5.2.3 Wound components supplied from the mains

One input circuit is connected to a voltage equal to a test voltage of at least 1,2 times the **rated voltage**, at double the **rated frequency** for 5 min. No load is connected to the transformer. During the test, multiple wire windings, if any, are connected in series.

A higher test frequency may be used; the duration of the period of connection, in minutes, then being equal to 10 times the **rated frequency** divided by the test frequency, but not less than 2 min.

The test voltage is initially set at **rated voltage** and gradually increased up to 1,2 times the initial value, and then maintained for the time specified. If during the test there is a non-linear change of current in an uncontrollable manner, it is regarded as breakdown between winding turns.

G.5.2.4 Compliance criteria

*For wound components supplied from the **mains**, there shall be no breakdown of the insulation between the turns of a winding, between input and output windings, between adjacent input windings and between adjacent output windings, or between the windings and any conductive core.*

G.5.3 Transformers

G.5.3.1 General

Transformers shall comply with one of the following:

- meet the requirements given in G.5.3.2 and G.5.3.3;
- IEC 61204-7 for a transformer used in a low-voltage power supply;
- meet the requirements of IEC 61558-1 and the relevant parts of IEC 61558-2 with the following additions and limitations:
 - the limit values for ES1 of this standard apply (see 5.2.2.2),
 - for **working voltages** above 1 000 V r.m.s., see 18.3 of IEC 61558-1:2005 using the test voltage specified in 5.4.9.1;
 - the overload test according to G.5.3.3;
- IEC 61558-2-16 for transformers used in a switch mode power supply.

NOTE Examples of relevant parts of IEC 61558-2 are:

- IEC 61558-2-1: Separating transformers;
- IEC 61558-2-4: Isolating transformers;
- IEC 61558-2-6: Safety isolating transformers.

G.5.3.2 Insulation

G.5.3.2.1 Requirements

Insulation in transformers shall comply with the following requirements.

Windings and conductive parts of transformers shall be treated as parts of the circuits to which they are connected, if any. The insulation between them shall comply with the relevant requirements of Clause 5 and pass the relevant electric strength tests, according to the application of the insulation in the equipment.

Precautions shall be taken to prevent the reduction below the required minimum values of **clearances** and **creepage distance** that provide **basic insulation**, **supplementary insulation** or **reinforced insulation** by:

- displacement of windings, or their turns;
- displacement of internal wiring or wires for external connections;
- undue displacement of parts of windings or internal wiring, in the event of rupture of wires adjacent to connections or loosening of the connections;
- bridging of insulation by wires, screws, washers and the like should they loosen or become free.

It is not expected that two independent fixings will loosen at the same time.

All windings shall have the end turns retained by positive means.

Examples of acceptable forms of construction are the following (there are other acceptable forms of construction):

- windings isolated from each other by placing them on separate limbs of the core, with or without spools;
- windings on a single spool with a partition wall, where either the spool and partition wall are pressed or moulded in one piece, or a pushed-on partition wall has an intermediate sheath or covering over the joint between the spool and the partition wall;
- concentric windings on a spool of insulating material without flanges, or on insulation applied in thin sheet form to the transformer core;
- insulation is provided between windings consisting of sheet insulation extending beyond the end turns of each layer;
- concentric windings, separated by an earthed conductive screen that consists of metal foil extending the full width of the windings, with suitable insulation between each winding and the screen. The conductive screen and its lead-out wire have a cross-section sufficient to ensure that on breakdown of the insulation an overload device will open the circuit before the screen is destroyed. The overload device may be a part of the transformer.

If a transformer is fitted with an earthed screen for protective purposes, the transformer shall pass the test of 5.6.6 between the earthed screen and the earthing terminal of the transformer.

No electric strength test applies to insulation between any winding and the core or screen, provided that the core or screen is totally enclosed or encapsulated and there is no electrical connection to the core or screen. However, the tests between windings that have terminations continue to apply.

G.5.3.2.2 Compliance criteria

Compliance is checked by inspection, measurement and where applicable by test.

G.5.3.3 Transformer overload tests

G.5.3.3.1 Test conditions

If the tests are carried out under simulated conditions on the bench, these conditions shall include any protective device that would protect the transformer in the complete equipment.

Transformers for switch mode power supply units are tested in the complete power supply unit or in the complete equipment. Test loads are applied to the output of the power supply unit.

*A linear transformer or a ferro-resonant transformer has each winding isolated from the **mains** loaded in turn, with any other winding isolated from the **mains** loaded between zero and its specified maximum load to result in the maximum heating effect.*

The output of a switch mode power supply is loaded to result in the maximum heating effect in the transformer.

*Where an **overload condition** cannot occur or is unlikely to cause a **safeguard** to fail, the tests are not made.*

G.5.3.3.2 Compliance criteria

Maximum temperatures of windings shall not exceed the values in Table G.3 when measured as specified in B.1.6, and determined as specified below:

- *with external overcurrent protection: at the moment of operation, for determination of the time until the overcurrent protection operates, reference may be made to a data sheet of the overcurrent protective device showing the trip time versus the current characteristics;*
- *with an automatic reset **thermal cut-off**: as shown in Table G.3 and after 400 h;*

- with a manual reset **thermal cut-off**: at the moment of operation;
- for current limiting transformers: after the temperature has stabilized.

If the temperature of the windings of a transformer with a ferrite core, measured as specified in B.1.6, exceeds 180 °C, it shall be retested at maximum rated ambient temperature ($T_{amb} = T_{ma}$), and not as calculated according to B.2.6.3.

Windings isolated from the **mains**, that exceed the temperature limits but that become open circuit or otherwise require replacement of the transformer, do not constitute a failure of this test provided that the transformer continues to comply with B.4.8.

During the test the transformer shall not emit flames or molten-metal.

Table G.3 – Temperature limits for transformer windings and for motor windings (except for the motor running overload test)

Method of protection	Maximum temperature °C							
	Class 105 (A)	Class 120 (E)	Class 130 (B)	Class 155 (F)	Class 180 (H)	Class 200 (N)	Class 220 (R)	Class 250 (-)
Protection by inherent or external impedance	150	165	175	200	225	245	265	295
Protection by protective device that operates during the first hour	200	215	225	250	275	295	315	345
Protection by any protective device:								
– maximum after first hour	175	190	200	225	250	270	290	320
– arithmetic average during the 2nd hour and during the 72nd hour ^a	150	165	175	200	225	245	265	295

The classes are related to the classification of electrical insulating materials and EIS in accordance with IEC 60085. The assigned letter designations are given in parentheses.

^a The arithmetic average temperature is determined as follows:

The graph of temperature against time (see Figure G.1), while the power to the transformer is cycling on and off, is plotted for the period of test under consideration. The arithmetic average temperature (t_A) is determined by the formula:

$$t_A = \frac{t_{max} + t_{min}}{2}$$

where

t_{max} is the average of the maxima,

t_{min} is the average of the minima.

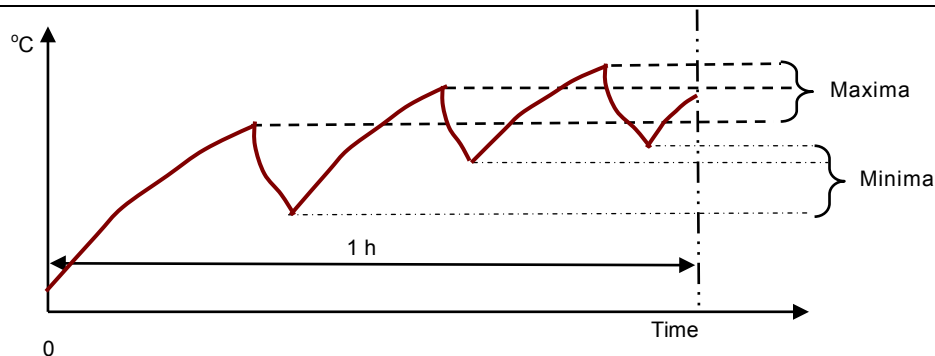

IEC 0374/14

Figure G.1 – Determination of arithmetic average temperature

G.5.3.3.3 Alternative test method

The transformer is covered with a single layer of **cheesecloth** and is placed on a wooden board that is covered with a single layer of **wrapping tissue**. The transformer is then gradually loaded until one of the following situations occurs:

- the overload protective device operates,
- the winding becomes an open circuit,
- the load cannot be increased any further without reaching a short-circuit or foldback condition,

The transformer is then loaded to a point just before the above applicable situation occurs and is operated for 7 h.

During the test the transformer shall not emit flames or molten metal. The **cheesecloth** shall not char or catch fire.

If the transformer voltage exceeds *ES1*, the **basic safeguard** or **reinforced safeguard** provided in the transformer shall withstand the electric strength test in 5.4.9.1 as applicable after it has cooled to room temperature.

G.5.4 Motors

G.5.4.1 General requirements

DC motors supplied from PS2 or PS3 circuits isolated from the a.c. **mains** shall comply with the tests of G.5.4.5, G.5.4.6 and G.5.4.9. DC motors that by their intrinsic operation normally operate under locked-rotor conditions, such as stepper motors, are not tested and d.c. motors that are used for air-handling only and where the air propelling component is directly coupled to the motor shaft are not required to pass the test of G.5.4.5.

All other motors supplied from PS2 or PS3 circuits shall comply with the overload tests of G.5.4.3 and G.5.4.4 and, where applicable, G.5.4.7, G.5.4.8 and G.5.4.9.

However, the following motors are exempt from the test of G.5.4.3:

- motors that are used for air-handling only and where the air-propelling component is directly coupled to the motor shaft; and
- shaded pole motors whose values of locked-rotor current and no-load current do not differ by more than 1 A and have a ratio of not more than 2/1.

G.5.4.2 Motor overload test conditions

Unless otherwise specified, during the test, the equipment is operated at **rated voltage** or at the highest voltage of the **rated voltage range**.

The tests are carried out either in the equipment or under simulated conditions on the bench. Separate samples may be used for bench tests. Simulated conditions include:

- any protective device that would protect the motor in the complete equipment; and
- use of any mounting means that may serve as a heat sink to the motor frame.

Temperatures of windings are measured as specified in B.1.6. Where thermocouples are used they are applied to the surface of the motor windings. Temperatures are measured at the end of the test period where specified, otherwise when the temperature has stabilized, or at the instant of operation of fuses, **thermal cut-offs**, motor protective devices and the like.

For totally enclosed, impedance-protected motors, the temperatures are measured by thermocouples applied to the motor case.

When motors without inherent thermal protection are tested under simulated conditions on the bench, the measured winding temperature is adjusted to take into account the ambient temperature in which the motor is normally located within the equipment.

G.5.4.3 Running overload test and compliance criteria

A running overload test is carried out by operating the motor under **normal operating conditions**. The load is then increased so that the current is increased in appropriate gradual steps, the motor supply voltage being maintained at its original value. When steady conditions are established, the load is again increased. The load is thus progressively increased in appropriate steps but without reaching locked-rotor condition (see G.5.4.4), until the overload protective device operates.

Compliance is checked by measuring the motor winding temperatures during each steady period. The measured temperatures shall not exceed the values in Table G.4.

Table G.4 – Temperature limits for running overload tests

Maximum temperature °C							
Class 105 (A)	Class 120 (E)	Class 130 (B)	Class 155 (F)	Class 180 (H)	Class 200 (N)	Class 220 (R)	Class 250 -
140	155	165	190	215	235	255	275
The classes are related to the classification of electrical insulating materials and EIS in accordance with IEC 60085. The assigned letter designations are given in parentheses.							

G.5.4.4 Locked-rotor overload

G.5.4.4.1 Test method

A locked-rotor test is carried out starting at room temperature.

The duration of the test is as follows:

- a motor protected by inherent or external impedance is operated on locked-rotor for 15 days except that testing is discontinued when the windings of the motor reach a constant temperature, provided that the constant temperature is not more than that specified in Table 10 for the insulation system used;
- a motor with an automatic reset protective device is cycled on locked-rotor for 18 days;
- a motor with a manual reset protective device is cycled on locked-rotor for 60 cycles, the protective device being reset after each operation as soon as possible for it to remain closed, but after not less than 30 s;
- a motor with a non-resettable protective device is operated until the device operates.

G.5.4.4.2 Compliance criteria

Compliance is checked by measuring temperatures at regular intervals during the first three days for a motor with inherent or external impedance protection or with an automatic reset protective device, or during the first 10 cycles for a motor with a manual reset protective device, or at the time of operation of a non-resettable protective device. The measured temperatures shall not exceed the values in Table 3.

During the test, protective devices shall operate reliably without permanent damage to the motor including:

- *severe or prolonged smoking or flaming;*
- *electrical or mechanical breakdown of any associated component part such as a capacitor or starting relay;*
- *flaking, embrittlement or charring of insulation;*
- *deterioration of the insulation.*

Discoloration of the insulation may occur, but charring or embrittlement to the extent that insulation flakes off or material is removed when the winding is rubbed with the thumb is not acceptable.

After the period specified for temperature measurement, the motor shall withstand the electric strength test of 5.4.9.1 after the insulation has cooled to room temperature and with test voltages reduced to 0,6 times of the specified values.

NOTE Continuation of the test of an automatic reset protective device beyond 72 h, and of a manual reset protective device beyond 10 cycles, is only for the purpose of demonstrating the capability of the device to make and break locked-rotor current for an extended period of time.

G.5.4.5 Running overload for d.c. motors

G.5.4.5.1 Requirement

The test of G.5.4.5.2 is carried out only if a possibility of an overload occurring is determined by inspection or by review of the design. For example, the test need not be carried out where electronic drive circuits maintain a substantially constant drive current.

If difficulty is experienced in obtaining accurate temperature measurements, due to the small size or unconventional design of the motor, the method of G.5.4.5.3 can be used instead.

G.5.4.5.2 Test method and compliance criteria

*The motor is operated under **normal operating conditions**. The load is then increased so that the current is increased in appropriate gradual steps, the motor supply voltage being maintained at its original value. When steady conditions are established, the load is again increased. The load is thus progressively increased in appropriate steps until either the overload protection device operates, the winding becomes an open circuit or the load cannot be increased any further without reaching a locked rotor condition.*

The motor winding temperatures are measured during each steady period. The measured temperatures shall not exceed the values in Table G.4.

*Following the test, if the motor voltage exceeds ES1, the **basic safeguard** or **reinforced safeguard** provided in the motor shall withstand the electric strength test in 5.4.9.1 after it has cooled to room temperature, but with test voltages reduced to 0,6 times the specified values.*

G.5.4.5.3 Alternative method

*The motor is covered with a single layer of **cheesecloth** and placed on a wooden board that is covered with a single layer of **wrapping tissue**. The motor is then gradually loaded until one of the following situations occur:*

- *the overload protective device operates;*
- *the winding becomes an open circuit;*

– *the load cannot be increased any further without reaching a locked rotor condition.*

The motor is then loaded to a point just before the above applicable situation occurs and is operated for 7 h.

*During the test, the motor shall not emit flames or molten metal. The **cheesecloth** shall not char or catch fire.*

*Following the test, if the motor voltage exceeds ES1, the **basic safeguard** or **reinforced safeguard** provided in the motor shall withstand the electric strength test in 5.4.9.1 after it has cooled to room temperature, but with test voltages reduced to 0,6 times the specified values.*

G.5.4.6 Locked-rotor overload for d.c. motors

G.5.4.6.1 Requirement

Motors shall pass the test in G.5.4.6.2.

Where difficulty is experienced in obtaining accurate temperature measurements because of the small size or unconventional design of the motor, the method of G.5.4.6.3 can be used instead.

G.5.4.6.2 Test method and compliance criteria

The motor is operated at the voltage used in its application and with its rotor locked for 7 h or until steady state conditions are established, whichever is longer. However, if the motor winding opens, or the motor otherwise becomes permanently de-energized, the test is discontinued.

Compliance is checked by measuring the motor winding temperatures during the test. The measured temperatures shall not exceed the values in Table G.3.

Following the test, if the motor voltage exceeds ES1, and after it has cooled to room temperature, the motor shall withstand the electric strength test in 5.4.9.1 but with test voltages reduced to 0,6 times the specified values.

G.5.4.6.3 Alternative method

*The motor is covered with a single layer of **cheesecloth** and placed on a wooden board that is covered with a single layer of **wrapping tissue**.*

The motor is then operated at the voltage used in its application and with its rotor locked for 7 h or until steady state conditions are established, whichever is the longer. However, if the motor winding opens, or the motor otherwise becomes permanently de-energized, the test is discontinued.

*During the test, the motor shall not emit flames or molten metal. The **cheesecloth** shall not char or catch fire.*

Following the test, if the motor voltage exceeds ES1, and after it has cooled to room temperature, the motor shall withstand the electric strength test in 5.4.9.1 but with test voltages reduced to 0,6 times the specified values.

G.5.4.7 Test method and compliance criteria for motors with capacitors

Motors having phase-shifting capacitors are tested under locked-rotor conditions with the capacitor short-circuited or open-circuited (whichever is the more unfavourable).

The short-circuit test is not made if the capacitor is so designed that, upon failure, it will not remain short-circuited.

Compliance is checked by measuring the motor winding temperatures during the test. The measured temperatures shall not exceed the values in Table G.3.

G.5.4.8 Test method and compliance criteria for three-phase motors

*Three-phase motors are tested under **normal operating conditions**, with one phase disconnected, unless circuit controls prevent the application of voltage to the motor when one or more supply phases are missing.*

The effect of other loads and circuits within the equipment may necessitate that the motor be tested within the equipment and with the three supply phases disconnected one at a time.

Compliance is checked by measuring the motor winding temperatures during the test. The measured temperatures shall not exceed the values in Table G.3.

G.5.4.9 Test method and compliance criteria for series motors

Series motors are operated at a voltage equal to 1,3 times the voltage rating of the motor for 1 min with the lowest possible load.

*After the test, windings and connections shall not have worked loose and all applicable **safeguards** shall remain effective.*

G.6 Wire insulation

G.6.1 General

The following requirements apply to all wires, including wires in wound components (see also Clause G.5), lead-out wires and the like, whose insulation provides **basic insulation**, **supplementary insulation** or **reinforced insulation**.

NOTE 1 For insulation provided in addition to insulation on winding wire, see 5.4.4.

If the **peak working voltage** does not exceed ES2, there is no dimensional or constructional requirement.

If the **peak working voltage** exceeds ES2, one of the following applies:

- a) There is no dimensional or constructional requirement for **basic insulation** that is not under mechanical stress (for example, from winding tension). For **basic insulation** that is under such mechanical stress, b) or c) applies.

NOTE 2 This exception does not apply to **supplementary insulation** or **reinforced insulation**.

- b) For **basic insulation**, **supplementary insulation** or **reinforced insulation**, the insulation on the wire shall either:
 - have a thickness of at least 0,4 mm provided by a single layer; or
 - comply with 5.4.4.6 and with Annex J.
- c) The winding wire shall comply with Annex J. The minimum number of overlapping layers of spirally wrapped tape or extruded layers of insulation shall be as follows:
 - for **basic insulation**: one layer;
 - for **supplementary insulation**: two layers;
 - for **reinforced insulation**: three layers.

For insulation between two adjacent winding wires, one layer on each conductor is considered to provide **supplementary insulation**.

Spirally wrapped tape wound with not more than 50 % overlap is considered to constitute one layer. Spirally wrapped tape wound with more than 50 % overlap is considered to constitute two layers.

Spirally wrapped tape shall be sealed and pass the tests of 5.4.4.5 a), b) or c).

NOTE 3 For wires insulated by an extrusion process, sealing is inherent to the process.

The winding wire shall pass a **routine test** for electric strength test, using the test as specified in J.3.2.

G.6.2 Solvent-based enamel winding insulation

Solvent-based enamel is not considered to provide **supplementary insulation** or **reinforced insulation**, under any circumstances.

Solvent-based enamel is considered **basic insulation** where all the following conditions are met:

- the insulation provides **basic insulation** in a wound component between an **external circuit** and an internal circuit operating at ES2 and ES1;
- the insulation over all conductors comprises enamel complying with the requirements of a grade 2 winding wire of IEC 60317 series of standards with the **routine test** conducted at the highest voltage of Table 26 and Table 27;
- the finished component is subjected to a **type test** for electric strength (between windings and between windings and the core, see G.5.3.2.1), in accordance with 5.4.9.1;
- the finished component is subjected to **routine tests** for electric strength (between windings and between windings and the core, see G.5.3.2.1), in accordance with 5.4.9.2.

Except as given in 4.3.2.3, the core of the above wound component shall not be **accessible** to an **ordinary person**.

G.7 Mains supply cords

G.7.1 General

A **mains** supply cord shall be of the sheathed type and comply with the following as appropriate:

- if rubber sheathed, be of synthetic rubber and not lighter than ordinary tough rubber-sheathed flexible cord according to IEC 60245-1 (designation 60245 IEC 53);
- if PVC sheathed:
 - for equipment provided with a **non-detachable power supply cord** and having a mass not exceeding 3 kg, be not lighter than light PVC sheathed flexible cord according to IEC 60227-1 (designation 60227 IEC 52),
 - for equipment provided with a **non-detachable power supply cord** and having a mass exceeding 3 kg, be not lighter than ordinary PVC sheathed flexible cord according to IEC 60227-1 (designation 60227 IEC 53),

NOTE 1 There is no limit on the mass of the equipment if the equipment is intended for use with a detachable power supply cord.

- for equipment provided with a detachable power supply cord, be not lighter than light PVC sheathed flexible cord according to IEC 60227-1 (designation 60227 IEC 52),

- for screened cords of **moveable equipment**, the flexing test of 3.1 of IEC 60227-2:2003;

NOTE 2 Although screened cords are not covered in the scope of IEC 60227-2, the relevant flexing tests of IEC 60227-2 are used.

- other types of cords may be used if they have similar electro-mechanical and fire safety properties as above.

NOTE 3 Where national or regional standards exist, they can be used to show compliance with the above paragraph.

For **pluggable equipment type A** or **pluggable equipment type B** that has protective earthing, a **protective earthing conductor** shall be included in the **mains** supply cord. For all other equipment, if a **mains** cord is supplied without a **protective earthing conductor**, a **protective earthing conductor** cable shall be supplied as well.

Equipment intended to be used by musicians while performing (for example, musical instruments and amplifiers) shall have:

- an appliance inlet according to IEC 60320-1 for connection to the **mains** by detachable cord sets; or
- a means of stowage to protect the **mains** cord when not in use (for example, a compartment, hooks or pegs).

Compliance is checked by inspection. For screened cords, damage to the screen is acceptable provided that:

- *during the flexing test the screen does not make contact with any conductor; and*
- *after the flexing test, the sample withstands the appropriate electric strength test between the screen and all other conductors.*

G.7.2 Cross sectional area

Mains supply cords shall have conductors with cross-sectional areas not less than those specified in Table G.5 (see also 5.6.3).

Table G.5 – Sizes of conductors

Rated current of the equipment ^a A up to and including	Minimum conductor sizes	
	Cross-sectional area mm ²	AWG or Kcmil [cross-sectional area in mm ²] ^e
3	0,5 ^b	20 [0,5]
6	0,75	18 [0,8]
10	1,00 (0,75) ^c	16 [1,3]
16	1,50 (1,0) ^d	14 [2]
25	2,5	12 [3]
32	4	10 [5]
40	6	8 [8]
63	10	6 [13]
80	16	4 [21]
100	25	2 [33]
125	35	1 [42]
160	50	0 [53]
190	70	000 [85]
230	95	0000 [107]
		Kcmil [cross-sectional area in mm ²] ^e
260	120	250 [126]
300	150	300 [152]
340	185	400 [202]
400	240	500 [253]
460	300	600 [304]
<p>NOTE 1 IEC 60320-1 specifies acceptable combinations of appliance couplers and flexible cords, including those covered by footnotes ^b, ^c and ^d. However, a number of countries have indicated that they do not accept all of the values listed in this table, particularly those covered by footnotes ^b, ^c and ^d.</p> <p>NOTE 2 For higher currents see the IEC 60364 series.</p>		
<p>^a The rated current includes currents that can be drawn from a socket outlet providing mains power for other equipment.</p> <p>^b For rated current up to 3 A, a nominal cross-sectional area of 0,5 mm² may be used in some countries provided that the length of the cord does not exceed 2 m.</p> <p>^c The value in parentheses applies to detachable power supply cords fitted with the connectors rated 10 A in accordance with IEC 60320-1 (types C13, C15, C15A and C17) provided that the length of the cord does not exceed 2 m.</p> <p>^d The value in parentheses applies to detachable power supply cords fitted with the connectors rated 16 A in accordance with IEC 60320-1 (types C19, C21 and C23) provided that the length of the cord does not exceed 2 m.</p> <p>^e AWG and kcmil sizes are provided for information only. The associated cross-sectional areas, in square brackets, have been rounded to show significant figures only. AWG refers to the American Wire Gage and the term "cmil" refers to circular mils where one circular mil is equal to the area of a circle having a diameter of one mil (one thousandth of an inch). These terms are commonly used to designate wire sizes in North America.</p>		

Compliance is checked by inspection.

G.7.3 Cord anchorages and strain relief for non-detachable power supply cords

G.7.3.1 General

Safeguards against strain being transmitted to the equipment terminations of the conductors of cords or interconnecting cables connected to ES2 circuits, ES3 circuits or PS3 circuits are specified below.

G.7.3.2 Cord strain relief

G.7.3.2.1 Requirements

A knot shall not be used as a strain relief mechanism.

A screw that bears directly on the cord or cable shall not be used as a strain relief mechanism unless the cord anchorage, including the screw, is made of insulating material and the screw is of comparable size to the diameter of the cord being clamped.

When a linear force and a torque are applied to a **non-detachable power supply cord** or cable, a **basic safeguard** shall minimize strain from being transmitted to the cord or cable terminations.

The linear force applied to the cord or cable is specified in Table G.6. The force is applied in the most unfavourable direction for 1 s and repeated 25 times.

Table G.6– Strain relief test force

Mass of the equipment kg	Force N
Up to and including 1	30
Over 1 up to and including 4	60
Over 4	100

A torque of 0,25 Nm is applied for 1 min to the cord or cable immediately after the linear force application. The torque is applied as close as practicable to the strain relief mechanism and is repeated in the opposite direction.

Compliance is determined by applying the specified force and torque, by measurement, and visual inspection. There shall be no damage to the cord or conductors and the displacement of the conductors shall not exceed 2 mm. Stretching of the cord outer jacket without displacement of the conductors is not considered displacement.

G.7.3.2.2 Strain relief mechanism failure

If the **basic safeguard** (strain relief mechanism) should fail and strain is transmitted to the **non-detachable power supply cord** or cable terminations, a **supplementary safeguard** shall ensure that the earth termination is the last to take the strain.

*Compliance is determined by inspection and, if necessary, by defeating the **basic safeguard** and inspecting the conductor slack while applying the force in Table G.6.*

G.7.3.2.3 Cord sheath or jacket position

The cord or cable sheath or jacket shall extend from the **basic safeguard** (strain relief mechanism) into the equipment at least one-half the diameter of the cord or cable.

Compliance is checked by inspection.

G.7.3.2.4 Strain relief and cord anchorage material

The cord anchorage shall either be made of insulating material or have a lining of insulating material complying with the requirements for **basic insulation**. Where the cord anchorage is a bushing that includes the electrical connection to the screen of a screened power cord, this requirement shall not apply.

If the **basic safeguard** (strain relief mechanism) is made of polymeric material, the **basic safeguard** shall retain its structural properties following the mould stress relief according to Clause T.8.

*Compliance is determined by inspection and by applying the force and torque tests of G.7.3.2.1 after the **basic safeguard** has come to room temperature.*

G.7.4 Cord entry

Safeguards against electric shock and electrically-caused fire from cords or cables connected to ES2 circuits, ES3 circuits or PS3 circuits are specified below.

The entry of a cord or cable into the equipment shall be provided with **safeguards** against electric shock as specified in Clause 5. If the cord jacket passes the electric strength test of 5.4.9.1 for **supplementary insulation**, the cord jacket may be considered a **supplementary safeguard**.

The cord or cable entry shall be provided with a **supplementary safeguard** to:

- prevent abrasion of the cord or cable outer surface; and
- prevent the cord or cable from being pushed into the equipment to such an extent that the cord or its conductors, or both, could be damaged or internal parts of the equipment could be displaced.

*Compliance is determined by an electric strength test between the cord or cable conductors and **accessible** conductive parts following the tests of G.7.3.2.1. The test voltage shall be for **reinforced insulation** in accordance with 5.4.9.1.*

G.7.5 Non-detachable cord bend protection

G.7.5.1 Requirements

The **non-detachable power supply cord** of **hand-held equipment** or equipment intended to be moved while in operation shall be provided with a **safeguard** against jacket, insulation, or conductor damage due to bending at the equipment entrance.

Alternatively, the inlet or bushing shall be provided with a smoothly rounded bell-mouthed opening having a radius of curvature equal to at least 1,5 times the overall diameter of the cord with the largest cross-sectional area to be connected.

The cord bending **safeguard** shall:

- be so designed as to protect the cord against excessive bending where it enters the equipment; and
- be of insulating material; and
- be fixed in a reliable manner; and
- project outside the equipment beyond the inlet opening for a distance of at least five times the overall diameter or, for flat cords, at least five times the major overall cross-sectional dimension of the cord.

G.7.5.2 Test method and compliance criteria

The equipment is so placed that the axis of the cord bending **safeguard**, where the cord emerges, projects at an angle of 45° when the cord is free from stress. A mass equal to $10 \times D^2$ g is then attached to the free end of the cord, where D is the overall diameter or, for flat cords, the minor overall dimension of the cord, in millimetres.

If the cord guard is of temperature-sensitive material, the test is made at $23 \text{ °C} \pm 2 \text{ °C}$.

Flat cords are bent in the plane of least resistance.

Immediately after the mass has been attached, the radius of curvature of the cord shall nowhere be less than $1,5 D$.

Compliance is checked by inspection, by measurement and, where necessary, by test with the cord as delivered with the equipment.

G.7.6 Supply wiring space

G.7.6.1 General requirements

The supply wiring space provided inside, or as part of, the equipment for permanent connection or for connection of an ordinary **non-detachable power supply cord** shall be designed:

- to allow the conductors to be introduced and connected easily; and
- so that the uninsulated end of a conductor is unlikely to become free from its terminal, or, should it do so, cannot come into contact with:
 - an **accessible** conductive part that is not connected to a **protective conductor**’ or
 - an **accessible** conductive part of **hand-held equipment**; and
- to permit checking before fitting the cover, if any, that the conductors are correctly connected and positioned; and
- so that covers, if any, can be fitted without risk of damage to the supply conductors or their insulation; and
- so that covers, if any, giving access to the terminals can be removed with a **tool**.

Compliance is checked by inspection and by an installation test with cords of the largest cross-sectional area of the appropriate range specified in Table G.4.

G.7.6.2 Stranded wire

G.7.6.2.1 Requirements

The end of a stranded conductor shall not be consolidated by soft soldering at places where the conductor is subject to contact pressure unless the method of clamping is designed so as to reduce the likelihood of a bad contact due to cold flow of the solder.

Spring terminals that compensate for the cold flow are considered to satisfy this requirement.

Preventing the clamping screws from rotating is not considered to be adequate.

Terminals shall be located, guarded or insulated so that, should a strand of a flexible conductor escape when the conductor is fitted, there is no likelihood of accidental contact between such a strand and:

- **accessible** conductive parts; or

- unearthed conductive parts separated from **accessible** conductive parts by **supplementary insulation** only.

G.7.6.2.2 Test method and compliance criteria

Compliance is checked by inspection and, unless a special cord is prepared in such a way as to prevent the escape of strands, by the following test.

A piece of insulation approximately 8 mm long is removed from the end of a flexible conductor having the appropriate nominal cross-sectional area. One wire of the stranded conductor is left free and the other wires are fully inserted into, and clamped in the terminal. Without tearing the insulation back, the free wire is bent in every possible direction, but without making sharp bends around the guard.

*If the conductor is an ES3 source, the free wire shall not touch any conductive part which is **accessible** or is connected to an **accessible** conductive part or, in the case of double insulated equipment, any conductive part which is separated from **accessible** conductive parts by **supplementary insulation** only.*

If the conductor is connected to an earthing terminal, the free wire shall not touch any ES3 source.

G.8 Varistors

G.8.1 General

A varistor shall comply with:

- the **safeguards** against electric shock of G.8.2; and
- the **safeguards** against fire of G.8.3 if the method “reduce the likelihood of ignition” of 6.4.1 is chosen.

The **safeguards** against fire of G.8.3 are not applicable to a varistor used in a suppression circuit whose clamping voltage (see IEC 61051-1) is above a.c. **mains transient voltage**.

NOTE 1 A varistor is sometimes referred to as an MOV or a VDR.

NOTE 2 Such connections described above make the varistor a **PIS**.

G.8.2 Safeguards against electric shock

A varistor shall comply with IEC 61051-2, whether a **fire enclosure** is provided or not, taking into account all of the following:

- Preferred climatic categories (see 2.1.1 of IEC 61051-2:1991):
 - lower category temperature: – 10 °C
 - upper category temperature: + 85 °C
 - duration of damp heat, steady state test: 21 days.
- Maximum continuous voltage:
 - at least 1,25 times the **rated voltage** of the equipment or
 - at least 1,25 times the upper voltage of the **rated voltage range**.

NOTE The maximum continuous voltages are not limited to values specified in 2.1.2 of IEC 61051-2:1991, other voltages can be used.

- Combination pulse (Table I group 1 of IEC 61051-2:1991, Amendment 1:2009).

For the test, a combination pulse is selected from subclause 2.3.6 in IEC 61051-2:1991, Amendment 1:2009. The test consists of 10 positive pulses or 10 negative pulses, each having a shape of 1,2/50 μ s for voltage and 8/20 μ s for current.

For the selection, a.c. **mains** voltage and overvoltage category, see Table 13.

Mains under 300 V is considered to be 300 V.

For overvoltage category IV of Table 13, a combination pulse 6kV/3kA is used except for 600 V, for which a combination pulse of 8 kV/4 kA is used. As an alternative, the combination pulse test of IEC 61051-2:1991, Amendment 1:2009 (2.3.6, Table I group 1 and Annex A), including consideration of the nominal **mains** voltage and overvoltage category, is acceptable.

In addition to the performance requirements of Table I group 1 of IEC 61051-2:1991 and Amendment 1:2009, the varistor voltage at the manufacturer's specified current after the test shall not have changed by more than 10 % when compared to the value before the test.

The body of surge suppression varistor shall comply with the needle flame according to IEC 60695-11-5, with the following test severities:

- Duration of application of the test flame: 10 s
- After flame time: 5 s

If the body of surge suppression varistor complies with **V-1 class material**, the needle flame test does not need to be performed.

G.8.3 Safeguards against fire

G.8.3.1 General

Supplementary safeguards to be provided against fire resulting from the failure of the varistor if the method “reduce the likelihood of ignition” of 6.4.1 is chosen are specified below.

A varistor shall be regarded as a **PIS**. In case the method “reduce the likelihood of ignition” is chosen, the varistor overload test of G.8.3.2; and **temporary overvoltage** test of G.8.3.3 shall be performed depending on the maximum continuous a.c. voltage of the varistor according to Table G.7.

Table G.7 – Varistor overload and temporary overvoltage test

Maximum continuous a.c. voltage of a varistor	Connection Between		
	L to N or L to L	L to PE	N to PE
1,25 $\times V_r$ to 2 $\times V_r$	G.8.3.2	G.8.3.2 and G.8.3.3	G.8.3.2 and G.8.3.3
Over 2 $\times V_r$ to 1 200 + 1,1 $\times V_r$	No test	G.8.3.3	G.8.3.3
Over 1 200 + 1,1 $\times V_r$	No test	No test	No test

V_r is the **rated voltage** or the upper voltage of the **rated voltage range** of the equipment.

G.8.3.2 Varistor overload test

The following test is simulated as required by Table G.7 to either a varistor or a surge suppression circuit containing varistors connected across the **mains** (L to L or L to N), line to protective earth (L to PE), or neutral to protective earth (N to PE).

The following test simulation circuit shall be used:

- Voltage is the a.c source of $2 \times V_r$.
- Current is the current resulted from a test resistor R_x connected in series with the a.c source.
- V_r is the **rated voltage** or the upper voltage of the **rated voltage range** of the equipment.

For line to neutral, if a fuse not exceeding 10 A is located in the equipment before and in series with the varistor, either an initial test resistor (R_1) may be used resulting in the same current as the fuse, or a short-circuit may be applied. If no fuse is connected in series, the test shall be performed with an initial test resistor $R_1 = 16 \times V_r$.

For line to protective earth and neutral to protective earth, the test shall be performed with an initial test resistor $R_1 = 16 \times V_r$.

If the circuit does not open immediately during the initial application of test current, the test shall be continued until temperature stability (see B.1.6).

Subsequently, the test shall be repeated with new values of R_x (R_2 , R_3 , R_4 , etc.) until the circuit opens.

- $R_2 = 8 \times V_r \Omega$
- $R_3 = 4 \times V_r \Omega$
- $R_4 = 2 \times V_r \Omega$
- $R_x = 0,5 \times (R_{x-1}) \Omega$

During the test, the circuit may open due to the operation of a protective device such as a fuse, a thermal fuse or a GDT.

Components in parallel with the varistor that may be affected by this test shall be disconnected.

During and following the test, there shall be no risk of fire and **equipment safeguards**, other than the varistor under test, shall remain effective.

G.8.3.3 Temporary overvoltage test

The **temporary overvoltage** test is simulated by the following test methods where applicable:

A varistor or a surge suppression circuit containing varistors connected between the **mains** conductors and the earth, “Line to Protective Earth” and “Neutral to Protective Earth”, the **temporary overvoltage** described below is applied. The test method and compliance criteria are described in 8.3.8.1 and 8.3.8.2 of IEC 61643-11.

- Line to Protective Earth:
 - withstand $1,71 \times U_0$ for 5 s.
 - withstand $1\,200 + 1,1 \times U_0$ V ac for 5 s or fail safely.
- Neutral to Protective Earth:

- *withstand 1 200 V a.c. for 200 ms.*

NOTE 1 U_0 is the nominal a.c. voltage of the system as defined in IEC 61643-11, which is the nominal line to neutral voltage (r.m.s. value of the a.c. voltage) of the system to which the EUT is intended to be connected.

If a surge suppression circuit is used, the combination pulse specified in G.8.2 is applied before this test.

During the test, the circuit may open due to the operation of a protective device such as a thermal fuse or a GDT.

NOTE 2 For different power distribution systems, the **temporary overvoltages** are defined in Annex B of IEC 61643-1.

Components in parallel with the varistor that may be affected by this test shall be disconnected.

G.9 Integrated circuit (IC) current limiters

G.9.1 Requirements

IC current limiters used for current limiting in power sources to become PS1 or PS2 are not shorted from input to output if all of the following conditions are met:

- the IC current limiters limit the current to manufacturer's defined value (not to be more than 5 A) under **normal operating conditions** with any specified drift taken into account;
- the IC current limiters are entirely electronic and have no means of manual operation or reset;
- the IC current limiters are supplied by a source whose output does not exceed 250 VA;
- the IC current limiters output current is limited to 5 A or less;
- the IC current limiters limit the current or voltage to the required value with the manufacturer's defined drift, as applicable, taken into account after each of the conditioning tests.

At the choice of the manufacturer, the conditioning tests shall be conducted in accordance with G.9.2, G.9.3 or G.9.4. IC current limiters that meet the test program of either G.9.2, G.9.3 or G.9.4 are considered to comply with the above requirements.

A different sample may be used for each test.

The power source for the tests should be capable of delivering 250 VA minimum unless the IC current limiter is tested in the end product.

G.9.2 Test program 1

Test program 1 consists of the following:

- *10 000 cycles of turning enable on and off with a $100 \Omega \pm 5 \Omega$ resistor and a $425 \mu\text{F} \pm 10 \mu\text{F}$ capacitor in parallel with the output;*
- *10 000 cycles of turning enable on and off with a ferrite-core inductor having $0,35 \text{ mH} \pm 0,1 \text{ mH}$ inductance at 1 kHz and a d.c. resistance not exceeding 1Ω ;*
- *10 000 cycles of turning enable on and off with the input connected to a capacitor rated $425 \mu\text{F} \pm 1 \mu\text{F}$ and shorting the output;*
- *10 000 cycles of turning the input pin on and off with a capacitor rated $425 \mu\text{F} \pm 1 \mu\text{F}$ connected to the input supply while keeping enable active and shorting the output;*

- 10 000 cycles of turning the input pin on and off with a ferrite-core inductor having $0,35 \text{ mH} \pm 0,1 \text{ mH}$ inductance at 1 kHz and a d.c. resistance not exceeding 1Ω connected to the input supply and return while keeping enable active and shorting the output;
- 50 cycles with the enable pin held active with the output open-circuited, each cycle consisting of shorting the output and then opening the output;
- 50 cycles with the enable pin held active while applying a short to the output, each cycle consisting of turning the power on and off;
- 50 cycles with the enable pin held active while power is applied, each cycle consisting of shorting the output, removing power, reapplying power, removing the short, followed by removal of power.

G.9.3 Test program 2

Test program 2 consists of the following:

- 50 cycles with the enable pin held active with the output open-circuited; each cycle consisting of shorting the output and then opening the output;
- 50 cycles with the enable pin held active while applying a short to the output; each cycle consisting of turning the power on and off;
- 50 cycles with the enable pin held active with the output loaded to maximum power, each cycle consisting of turning the power on and off;
- 50 cycles with the enable pin held active while power is applied, each cycle consisting of shorting the output, removing power, reapplying power, removing the short, followed by removal of power;
- 3 cycles of exposing the device (not energized) to $70 \text{ }^\circ\text{C} \pm 2 \text{ }^\circ\text{C}$ for 24 h; followed by at least 1 h at room ambient; followed by at least 3 h at $-30 \text{ }^\circ\text{C} \pm 2 \text{ }^\circ\text{C}$; followed by 3 h at room ambient;
- 10 cycles of exposing the device (while energized) to $50 \text{ }^\circ\text{C} \pm 2 \text{ }^\circ\text{C}$ for 10 min; followed by 10 min at $0 \text{ }^\circ\text{C} \pm 2 \text{ }^\circ\text{C}$ with a 5 min period of transition from one state to the other;
- 7 days with the output short-circuited and the device wrapped in a double layer of **cheesecloth**. A quick acting 5 A fuse kept in series with the output shall not open and a current meter shall not show a current of more than 5 A.

G.9.4 Test program 3

Test program 3 consists of the following:

- Subclause H.17.1.4.2 of IEC 60730-1:2010;
- 10 000 cycles of turning enable on and off with a 100Ω resistor and $425 \mu\text{F}$ capacitor in parallel with the output;
- 10 000 cycles of turning enable on and off with a ferrite-core inductor having $0,35 \text{ mH} \pm 0,1 \text{ mH}$ inductance at 1 kHz and a d.c. resistance not exceeding 1Ω connected in the output circuit;
- 10 000 cycles of turning enable on and off while input connected to a capacitor rated $425 \mu\text{F}$ and shorting the output;
- 10 000 cycles of turning input pin on and off while a capacitor rated $425 \mu\text{F}$ to the input supply keeping enable active and shorting the output;
- 10 000 cycles of turning input pin on and off with a ferrite-core inductor having $0,35 \text{ mH} \pm 0,1 \text{ mH}$ inductance at 1 kHz and a d.c. resistance not exceeding 1Ω connected to the input supply keeping enable active and shorting the output;
- 50 cycles with enable pin held active and applying short to output with power on and off;

- 50 cycles with enable pin held active and output loaded to maximum power with power on and off;
- 50 cycles with enable pin held active and applying power, apply short to output; remove power, apply power, remove short, remove power;
- 3 cycles of exposing the device (not energized) to 70 °C for 24 h; followed by at least 1 h at room ambient; followed by at least 3 h at –30 °C; followed by 3 h at room ambient;
- 10 cycles of exposing the device (while energized) to 49 °C for 10 min; followed by 10 min at 0 °C with a 5 min period of transition from one state to the other.

G.9.5 Compliance criteria

After each of the tests above, the device shall limit the current in accordance with its specification as applicable or the device shall become open circuit. The open circuited device is replaced with a new sample and tests continued as applicable.

G.10 Resistors

G.10.1 General

When required by 5.5.6, ten samples are tested for the resistor test of G.10.2. A sample is a single resistor if used alone, or a group of resistors in series.

G.10.2 Resistor test

Before the test, the resistance of ten samples is measured.

The samples shall be subjected to the damp heat test according to IEC 60068-2-78, with the following details:

- temperature: (40 ± 2) °C;
- humidity: (93 ± 3) % relative humidity;
- test duration: 21 days.

Each sample is then subjected to 10 impulses of alternating polarity, using the impulse test generator circuit 2 of Table D.1. The interval between successive impulses is 60 s, and U_c is equal to the applicable **required withstand voltage**.

After the test, the resistance of each sample shall not have changed by more than 10 %. No failure is allowed.

The lowest resistance value of the ten samples tested is used to measure the current when determining compliance with Table 4.

NOTE If a resistor or a group of resistors is connected between a circuit supplied by the **mains** and coaxial cable, G.10.3 applies.

G.10.3 Resistors serving as safeguards between the mains and an external circuit consisting of a coaxial cable

G.10.3.1 General

Test requirements for resistors bridging insulation between the **mains** and an **external circuit** consisting of a coaxial cable and that ensure that they do not significantly change in value over a long period of time are given below.

Ten samples of resistors (a sample is a single resistor if used alone or a group of resistors in series) are subjected to the conditioning of G.10.2 and followed by the test of G.10.3.2 or G.10.3.3 as applicable.

G.10.3.2 Voltage surge test

Each sample is subjected to 50 discharges from the impulse test generator circuit 3 of Table D.1, at not more than 12 discharges per minute, with U_c equal to 10 kV if the sample resistor is connected to coaxial cable connected to antenna (see Table 14).

G.10.3.3 Impulse test

Each sample is subjected to 10 pulses from the impulse test generator circuit 1 of Table D.1, with U_c equal to 4 kV or 5 kV of alternating polarity with a minimum of 60 s interval between pulses as applicable (see Table 14).

G.10.3.4 Compliance criteria

After the tests of G.10.3.2 or G.10.3.3, the resistance of each sample shall not have changed by more than 20 %. No failure is allowed.

G.11 Capacitors and RC units

G.11.1 General

The requirements below specify conditioning criteria when testing capacitors and RC units or discrete components forming an RC unit and serving as **safeguards** and provides selection criteria for capacitors and RC units that comply with IEC 60384-14.

G.11.2 Conditioning of capacitors and RC units

When required by 5.5.2.1, the following conditioning is applied when evaluating a capacitor or an RC unit to the requirements of IEC 60384-14.

The duration of the damp heat, steady-state test as specified in 4.12 of IEC 60384-14:2005, shall be 21 days at a temperature of (40 ± 2) °C and a relative humidity of (93 ± 3) %.

Capacitors subjected to a duration that is longer than 21 days during the above test are considered acceptable.

G.11.3 Rules for selecting capacitors

The appropriate capacitor subclass shall be selected from those listed in Table G.8, according to the rules of application in the table.

Table G.8 – Capacitor ratings according to IEC 60384-14

Capacitor subclass according to IEC 60384-14	Rated voltage of the capacitor V r.m.s.	Type test impulse test voltage of the capacitor kV peak	Type test r.m.s. test voltage of the capacitor kV r.m.s.
Y1	Up to and including 500	8	4
Y2	Over 150 up to and including 300	5	1,5
Y4	Up to and including 150	2,5	0,9
X1	Up to and including 760	4 ^a	-
X2	Up to and including 760	2,5 ^a	-

Rules for the application of this table.

- The voltage rating of the capacitor shall be at least equal to the **r.m.s. working voltage** across the insulation being bridged, determined according to 5.4.1.8.2.
- For a single capacitor (X type) serving as **functional insulation**, failure of the capacitor shall not result in the failure of a **safeguard** and the **type test** impulse test voltage shall be at least equal to the **required withstand voltage**.
- A higher grade capacitor than the one specified may be used, as follows:
 - subclass Y1 if subclass Y2 is specified;
 - subclass Y1 or Y2 if subclass Y4 is specified;
 - subclass Y1 or Y2 if subclass X1 is specified;
 - subclass X1, Y1 or Y2 if subclass X2 is specified.
- Two or more capacitors may be used in series in place of the single capacitor specified, as follows:
 - subclass Y1 or Y2 if subclass Y1 is specified;
 - subclass Y2 or Y4 if subclass Y2 is specified;
 - subclass X1 or X2 if subclass X1 is specified.
- If two or more capacitors are used in series they shall comply with 5.5.2.1 as applicable and comply with the other rules above.

^a For capacitance values of more than 1 μF, this test voltage is reduced by a factor equal to \sqrt{C} , where C is the capacitance value in μF.

G.11.4 Examples of the application of capacitors

Table G.9 gives examples for the number of Y capacitors required bridging **basic insulation**, **supplementary insulation** or **reinforced insulation** based on the **required withstand voltage**. Table G.10 gives the maximum voltage that can appear across a Y capacitor based on the **peak working voltage**.

Table G.11 gives examples for the number of Y capacitors required bridging **basic insulation** and **reinforced insulation** based on the **temporary overvoltages**. Table G.12 gives examples of the application of X capacitors selected in accordance with Table G.8.

Table G.9 – Examples of the application of Y capacitors based on the test voltages of Table 26

AC mains supply voltage up to and including V r.m.s.	Overvoltage category	Mains transient voltage kV	Bridged insulation	Capacitor type	Required number of capacitors
150	II	1,5	B or S	Y2	1
	II	1,5	D or R	Y2	2
	II	1,5	D or R	Y1	1
	III	2,5	B or S	Y2	2
	III	2,5	D or R	Y1	1
	IV	4,0	B or S	Y1	1
	IV	4,0	D or R	Y1	2
300	II	2,5	B or S	Y2	2
	II	2,5	D or R	Y1	1
	II	2,5	D or R	Y2	2
	III	4,0	B or S	Y1	1
	III	4,0	B or S	Y2	2
	III	4,0	D or R	Y1	2
	III	4,0	D or R	Y2	3
	IV	6,0	B or S	Y1	2
	IV	6,0	D or R	Y1	2
500	II	4,0	B or S	Y1	1
	II	4,0	D or R	Y1	2
	III	6,0	B or S	Y1	2
	III	6,0	D or R	Y1	2
	IV	8,0	B or S	Y1	2
	IV	8,0	D or R	Y1	3
B basic insulation S supplementary insulation			D double insulation R reinforced insulation		

Table G.10 – Examples of the application of Y capacitors based on the test voltages of Table 27

Capacitor type	Bridged insulation	Peak working voltage across the capacitor not to exceed kV
Any type ^a	B	Capacitors located in circuits isolated from the mains ^b , shall comply with the electric strength test of 5.4.9.1
Y4	B or S	0,978
Y4	D or R	0,795
Y2	B or S	1,631
Y2	D or R	1,325
Y1	B or S	4,350
Y1	D or R	3,535
^a For capacitors that bridge basic insulation and are located in circuits isolated from the mains , see 5.5.2.1. ^b For application of Y capacitor located in circuits connected to the mains , see Table G.9 and Table G.11.		
B basic insulation S supplementary insulation		D double insulation R reinforced insulation

Table G.11 – Examples of the application of Y capacitors based on the test voltages of Table 28

Nominal mains voltage V r.m.s. up to and including	Bridged insulation	Capacitor type	Number of capacitors
250	B	Y2	1
	R	Y2	2
	B	Y1	1
	R	Y1	1
600	B	Y2	2
	R	Y2	3
	B	Y1	1
	R	Y1	1
B basic insulation R reinforced insulation			

Table G.12 – Examples of the application of X capacitors, line to line or line to neutral

AC mains supply voltage up to and including V r.m.s.	Overvoltage category	Mains transient voltage kV	Capacitor type	Required number of capacitors based on required withstand voltage
150	II	1,5	X2	1
	III	2,5	X2	1
	IV	4,0	X1	1
250	II	2,5	X2	1
	III	4,0	X1	1
	IV	6,0	X1	2
500	II	4,0	X1	1
	III	6,0	X1	2
	IV	8,0	X1	2

G.12 Optocouplers

Optocouplers shall comply with the requirements of IEC 60747-5-5:2007. In the application of IEC 60747-5-5:2007,

- the **type testing** as specified in 7.4.3 of IEC 60747-5-5:2007 shall be performed with a voltage $V_{ini,a}$ that is at least equal to the appropriate test voltage in 5.4.9.1 of this standard, and
- the **routine testing** as specified in 7.4.1 of IEC 60747-5-5:2007 shall be performed with a voltage $V_{ini,b}$ that is at least equal to the appropriate test voltage in 5.4.9.2 of this standard.

G.13 Printed boards

G.13.1 General

The requirements for **basic insulation**, **supplementary insulation**, **reinforced insulation** and **double insulation** on printed boards are specified below.

These requirements also apply to the windings of a planar transformer.

G.13.2 Uncoated printed boards

The insulation between conductors on the outer surfaces of an uncoated printed board shall comply with the minimum **clearance** requirements of 5.4.2 and the minimum **creepage distance** requirements of 5.4.3.

Compliance is checked by inspection and by measurement.

G.13.3 Coated printed boards

The requirements for separation distances before the boards are coated are specified below.

An alternative method to qualify coated printed boards is given in IEC 60664-3.

For printed boards whose outer surfaces are to be coated with a suitable coating material, the minimum separation distances of Table G.13 apply to conductive parts before they are coated.

Double insulation and **reinforced insulation** shall pass **routine tests** for electric strength of 5.4.9.2.

Either one or both conductive parts and the entire distances over the surface between the conductive parts shall be coated.

The minimum **clearances** of 5.4.2 and the minimum **creepage distances** of 5.4.3 shall apply:

- if the above conditions are not met;
- between any two uncoated conductive parts; and
- over the outside of the coating.

Compliance is checked by inspection and measurement, taking Figure O.11 and Figure O.12 into account, and by the tests of G.13.6.

Table G.13 – Minimum separation distances for coated printed boards

Peak working voltage up to and including V peak	Basic insulation or supplementary insulation mm	Reinforced insulation mm
71 ^a	0,025	0,05
89 ^a	0,04	0,08
113 ^a	0,063	0,125
141 ^a	0,1	0,2
177 ^a	0,16	0,32
227 ^a	0,25	0,5
283 ^a	0,4	0,8
354 ^a	0,56	1,12
455 ^a	0,75	1,5
570	1,0	2,0
710	1,3	2,6
895	1,8	3,6
1 135	2,4	3,8
1 450	2,8	4,0
1 770	3,4	4,2
2 260	4,1	4,6
2 830	5,0	5,0
3 540	6,3	6,3
4 520	8,2	8,2
5 660	10	10
7 070	13	13
8 910	16	16
11 310	20	20
14 140	26	26
17 700	33	33
22 600	43	43
28 300	55	55
35 400	70	70
45 200	86	86
Linear interpolation may be used between the nearest two points, the calculated spacing being rounded up to the next higher 0,1 mm increment.		
^a The test of G.13.6 is not required.		

G.13.4 Insulation between conductors on the same inner surface

The requirements for insulation on the same inner layer of a multilayer board are specified below.

On an inner surface of a multi-layer printed board (see Figure O.17), the path between any two conductors shall comply with the requirements for a cemented joint in 5.4.4.5.

G.13.5 Insulation between conductors on different surfaces

The requirements for insulation on the different layers of a multilayer board are specified below.

For **basic insulation** there is no thickness requirement.

Supplementary insulation or **reinforced insulation** between conductive parts on different surfaces in double-sided single-layer printed boards, multi-layer printed boards and metal core printed boards, shall either have a minimum thickness of 0,4 mm provided by a single layer or conform with one of the specifications and pass the relevant tests in Table G.14.

Table G.14 – Insulation in printed boards

Specification of insulation	Type tests ^a	Routine tests for electric strength ^c
Two layers of sheet insulating material including pre-preg ^b	No	Yes
Three or more layers of sheet insulating material including pre-preg ^b	No	No
An insulation system with ceramic coating over a metallic substrate, cured at ≥ 500 °C	No	Yes
An insulation system, with two or more coatings other than ceramic over a metallic substrate, cured at < 500 °C	Yes	Yes
NOTE 1 Pre-preg is the term used for a layer of glass cloth impregnated with a partially cured resin.		
NOTE 2 For definition of ceramic, see IEC 60050-212:2010, 212-15-25.		
^a Thermal conditioning of G.13.6.2 followed by the electric strength test of 5.4.9.1.		
^b Layers are counted before curing.		
^c Electric strength testing is carried out on the finished printed board.		

G.13.6 Tests on coated printed boards

G.13.6.1 Sample preparation and preliminary inspection

Three sample printed boards (or, for coated components in Clause G.14, two components and one board) identified as samples 1, 2 and 3 are required. Either actual boards or specially produced samples with representative coating and minimum separations may be used. Each sample board shall be representative of the minimum separations used, and coated. Each sample is subjected to the full sequence of manufacturing processes, including soldering and cleaning, to which it is normally subjected during equipment assembly.

When visually inspected, the boards shall show no evidence of pinholes or bubbles in the coating or breakthrough of conductive tracks at corners.

G.13.6.2 Test method and compliance criteria

Sample 1 is subjected to the thermal cycling sequence of 5.4.1.5.3.

Sample 2 is aged in a full draught oven at a temperature and for a time duration chosen from the graph shown in Figure G.2 using the temperature index line that corresponds to the maximum operating temperature of the coated board. The temperature of the oven is maintained at the specified temperature ± 2 °C. The temperature used to determine the temperature index line is the highest temperature on the board where safety is involved.

When using Figure G.2, interpolation may be used between the nearest two temperature index lines.

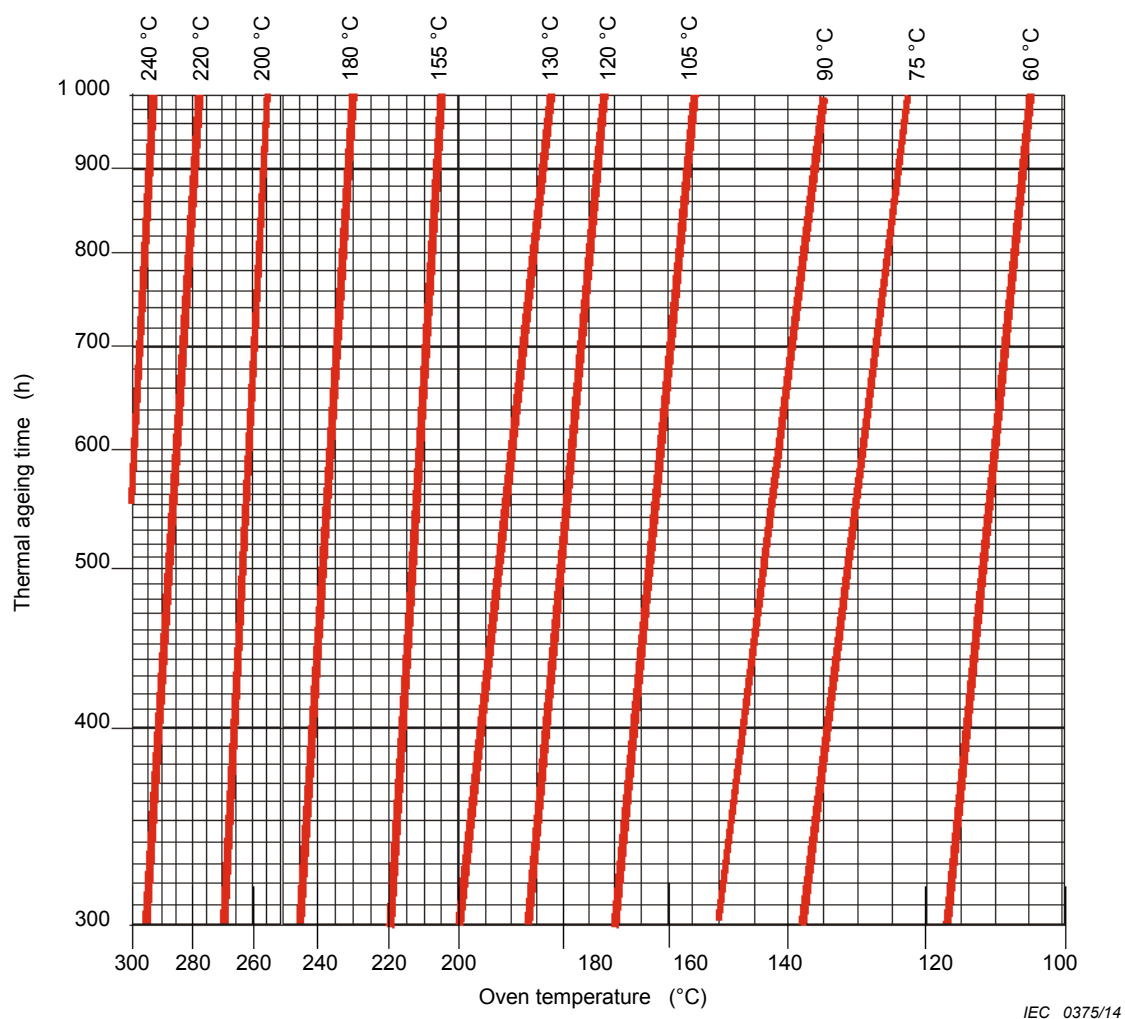

Figure G.2 – Thermal ageing time

Samples 1 and 2 are then subjected to the humidity conditioning of 5.4.8 and shall withstand the electric strength test of 5.4.9.1 between conductors.

Sample board 3 is subjected to the following abrasion resistance test:

Scratches are made across five pairs of conducting parts and the intervening separations at points where the separations will be subject to the maximum potential gradient during the tests.

The scratches are made by means of a hardened steel pin, the end of which has the form of a cone having a tip angle of 40°, its tip being rounded and polished, with a radius of 0,25 mm ± 0,02 mm.

Scratches are made by drawing the pin along the surface in a plane perpendicular to the conductor edges at a speed of 20 mm/s ± 5 mm/s as shown in Figure G.3. The pin is so loaded that the force exerted along its axis is 10 N ± 0,5 N. The scratches shall be at least 5 mm apart and at least 5 mm from the edge of the specimen.

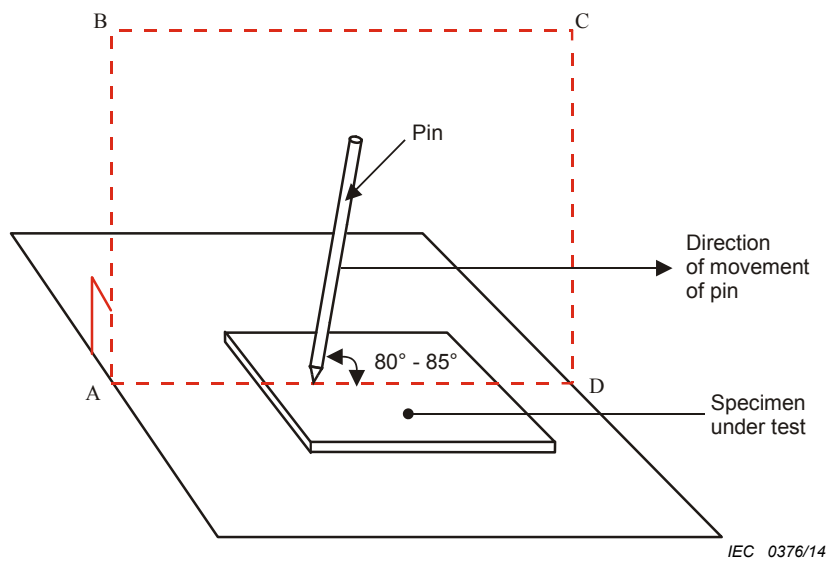

NOTE The pin is in the plane ABCD that is perpendicular to the specimen under test.

Figure G.3 – Abrasion resistance test for coating layers

After the test, the coating layer shall neither have loosened nor have been pierced. The coating shall withstand an electric strength test as specified in 5.4.9.1 between conductors. In the case of metal core printed boards, the substrate is one of the conductors.

NOTE If mechanical stress or bending is applied to the board, additional tests to identify cracking may be needed (see IEC 60664-3).

G.14 Coatings on component terminals

G.14.1 Requirements

The requirements for coatings on component terminals and the like, where the coating is used to reduce **clearances** and **creepage distances** are specified below.

Coatings may be used over external terminations of components to increase effective **clearances** and **creepage distances** (see Figure O.11). The minimum separation distances of Table G.13 apply to the component before coating, and the coating shall meet all the requirements of G.13.3. The mechanical arrangement and rigidity of the terminations shall be adequate to ensure that, during normal handling, assembly into equipment and subsequent use, the terminations will not be subject to deformation that would crack the coating or reduce the separation distances between conductive parts below the values in Table G.13 (see G.13.3).

G.14.2 Test method and compliance criteria

Compliance is checked by inspection taking into account Figure O.11 and by applying the sequence of tests covered by G.13.6. These tests are carried out on a completed assembly including the component(s).

The abrasion resistance test of G.13.6.2 is carried out on a specially prepared sample printed board as described for sample 3 in G.13.6.1, except that the separation between the conductive parts shall be representative of the minimum separations and maximum potential gradients used in the assembly.

G.15 Pressurized liquid filled components

G.15.1 General

Construction and test requirements for pressurized LFCs used inside the equipment where an injury can occur within the meaning of this standard due to leaks of the liquid in the LFC are specified below.

This subclause does not apply to the following:

- an LFC that is sealed but open to the atmosphere in the equipment; or
- components containing small amounts of liquids not likely to cause any injury (for example, liquid crystal displays, electrolytic capacitors, liquid cooling heat pipes, etc.); or
- wet **cell batteries** (for wet **cell batteries**, see Annex M).
- an LFC and its associated parts that comply with P.3.3.

G.15.2 Requirements

An LFC located internal to the equipment shall comply with all of the following requirements:

- flammable or conductive liquid shall be stored in a container, and the LFC shall comply with the tests of G.15.3.3, G.15.3.4, G.15.3.5 and G.15.3.6;
- the liquid shall be provided with protection in accordance with Clause 7 (hazardous substances);
- non-metallic parts of the container system shall withstand the tests of G.15.3.1 and G.15.3.2;
- the LFC shall be mounted within the equipment in such a way that the tubing shall not come into contact with sharp edges or any other surface that could damage the tubing and if the LFC bursts or relieves its pressure, the fluid cannot come in contact with ES3 parts.

The order of tests is not specified. The tests may be performed on separate samples, except after the test of G.15.3.2, the test of G.15.3.1 is conducted.

G.15.3 Test methods and compliance criteria

G.15.3.1 Hydrostatic pressure test

Compliance is checked by evaluation of the available data or by the following test. An LFC that is open to the atmosphere or is non-pressurised (for example, an ink cartridge) is not subjected to this test.

One sample of the LFC is subjected to a hydrostatic pressure test for 2 min at room temperature and at a pressure that is the highest of the following:

- *five times the maximum working pressure specified by the manufacturer at the maximum temperature measured during **normal operating conditions**; and*
- *three times the maximum measured working pressure at the maximum temperature measured during application of the **abnormal operating conditions** of Clause B.3 and **single fault conditions** of Clause B.4.*

G.15.3.2 Creep resistance test

Two samples of the LFC, of which one or more parts are made of non-metallic materials, shall be conditioned for 14 days at a temperature of 87 °C and placed in a full draft air-circulating oven. Following the conditioning, the system shall comply with the test of G.15.3.1 and non-metallic parts shall show no sign of deterioration such as cracking and embrittlement.

G.15.3.3 Tubing and fittings compatibility test

Ten samples of the test specimens made of the material used for the tubing and associated fittings of the LFC, of which one or more parts are made of non-metallic materials, shall be tested for tensile strength in accordance with the ISO 527 series. Five specimens shall be tested in the as received condition and the remaining five specimens after a conditioning test for 40 days at 38 °C in a full draft air-circulating oven or in a water bath filled with the intended liquid and maintained at 38 °C. The internal pressure of the assemblies is maintained at atmospheric pressure. The tensile strength after conditioning shall not be less than 60 % of the tensile strength before the tests.

G.15.3.4 Vibration test

One sample of the LFC, or the equipment containing the LFC, shall be fastened to the vibration generator in its normal position of use, as specified in IEC 60068-2-6, by means of screws, clamps or straps round the component. The direction of vibration is vertical, and the severities are:

- duration: 30 min;
- amplitude: 0,35 mm;
- frequency range: 10 Hz, 55 Hz, 10 Hz;
- sweep rate: approximately one octave per minute.

G.15.3.5 Thermal cycling test

One sample of the LFC is subjected to three cycles of conditioning for 7 h at a temperature that is 10 °C above the maximum temperature obtained during **normal operating conditions**, **abnormal operating conditions** of Clause B.3 and **single fault conditions** of Clause B.4, followed by room temperature for 1 h.

NOTE The LFC is not energized during the above test.

G.15.3.6 Force test

One sample of the LFC is subjected to the tests of Clause T.2 (10 N test applied to fittings **accessible to a skilled person**) and Clause T.3 (30 N test applied to fittings **accessible to an instructed person or to an ordinary person**).

G.15.4 Compliance criteria

Compliance is checked by inspection and evaluation of the available data or by the tests of G.15.3. During and after these tests, there shall be no rupture, no leaks and no loosening of any connection or part.

G.16 IC including capacitor discharge function (ICX)

G.16.1 Requirements

An ICX and any associated components critical to the discharge function of a capacitor to an **accessible** part (such as the **mains** capacitor) are not fault tested if one of the following conditions is met:

- the ICX with the associated circuitry as provided in the equipment complies with the tests of G.16.2. Any impulse attenuating components (such as varistors and GDTs) that attenuate the impulse to the ICX and the associated circuitry are disconnected. If discharge components external to the ICX are necessary, they shall not fail during the tests; or
- the ICX tested separately complies with the requirements of G.16.2. If discharge components external to the ICX are necessary:

- they shall be included in the test of G.16.2, and
- they shall not fail during the tests, and
- the discharge components used in the equipment shall be within the range tested.

G.16.2 Tests

Where the ICX is tested by itself, the test set up shall be as recommended by the ICX manufacturer.

- *humidity treatment of 5.4.8 for 120 h.*
- *100 positive impulses and 100 negative impulses between line and neutral using a capacitor with the largest capacitance and a resistor with the smallest resistance specified by the manufacturer of the ICX; and repeated with a capacitor with the smallest capacitance and the resistor with the largest resistance. The time between any two impulses shall not be less than 1 s. The impulse shall be as specified in circuit 2 of Table D.1 with U_c equal to the transient voltage.*
- *Application of an a.c. voltage that is 110 % of the **rated voltage** for 2,5 min.*
- *10 000 cycles of power on and off using a capacitor with the smallest capacitance and a resistor with the largest resistance as specified by the manufacturer of ICX. The power on and off cycles time shall not be less than 1 s.*

If any of the associated circuitry components other than those critical for the discharge function fails, it may be replaced with a new component.

G.16.3 Compliance criteria

*Compliance is checked by evaluation of the available data or by conducting the above tests. The capacitor discharge test is conducted after the above tests, ensuring the ICX or the EUT provided with the ICX continues to provide the **safeguard** function.*

NOTE Evaluation of available data should include information of failure of any associated circuitry components keeps the discharge mode in the on/stay mode

Annex H (normative)

Criteria for telephone ringing signals

H.1 General

The two alternative methods described in this annex reflect satisfactory experience in different parts of the world. Method A is typical of analogue telephone networks in Europe, and Method B of those in North America. The two methods result in standards of electrical safety that are broadly equivalent.

H.2 Method A

This method requires that the currents I_{TS1} and I_{TS2} flowing through a 5 000 Ω resistor, between any two conductors or between one conductor and protective earth do not exceed the limits specified, as follows:

a) For **normal operating conditions**, I_{TS1} , the current determined from the calculated or measured current for any single active ringing period t_1 (as defined in Figure H.1), does not exceed:

- for cadenced ringing ($t_1 < \infty$), the current given by the curve of Figure H.2 at t_1 ;
- for continuous ringing ($t_1 = \infty$), 16 mA.

I_{TS1} , in mA, is as given by

$$I_{TS1} = \frac{I_p}{\sqrt{2}} \quad \text{for } (t_1 \leq 600 \text{ ms})$$

$$I_{TS1} = \frac{t_1 - 600}{600} \times \frac{I_{pp}}{2\sqrt{2}} + \frac{1200 - t_1}{600} \times \frac{I_p}{\sqrt{2}} \quad \text{for } (600 \text{ ms} < t_1 < 1200 \text{ ms})$$

$$I_{TS1} = \frac{I_{pp}}{2\sqrt{2}} \quad \text{for } (t_1 \geq 1200 \text{ ms})$$

where

- I_p is the peak current, in mA, of the relevant waveform given in Figure H.3;
- I_{pp} is the peak-to-peak current, in mA, of the relevant waveform given in Figure H.3;
- t_1 is expressed in ms.

b) For **normal operating conditions**, I_{TS2} , the average current for repeated bursts of a cadenced ringing signal calculated for one ringing cadence cycle t_2 (as defined in Figure H.1), does not exceed 16 mA r.m.s.

I_{TS2} in mA is as given by

$$I_{TS2} = \left[\frac{t_1}{t_2} \times I_{TS1}^2 + \frac{t_2 - t_1}{t_2} \times \frac{I_{dc}^2}{3,75^2} \right]^{1/2}$$

where

- I_{TS1} in mA, is as given by H.2 a);
- I_{dc} is the d.c. current in mA flowing through the 5 000 Ω resistor during the non-active period of the cadence cycle;
- t_1 and t_2 are expressed in ms.

NOTE The frequencies of telephone ringing voltages are normally within the range of 14 Hz to 50 Hz.

c) Under **single fault conditions**, including where cadenced ringing becomes continuous:

- I_{TS1} shall not exceed the current given by the curve of Figure H.2, or 20 mA, whichever is greater; and
- I_{TS2} shall not exceed a limit of 20 mA.

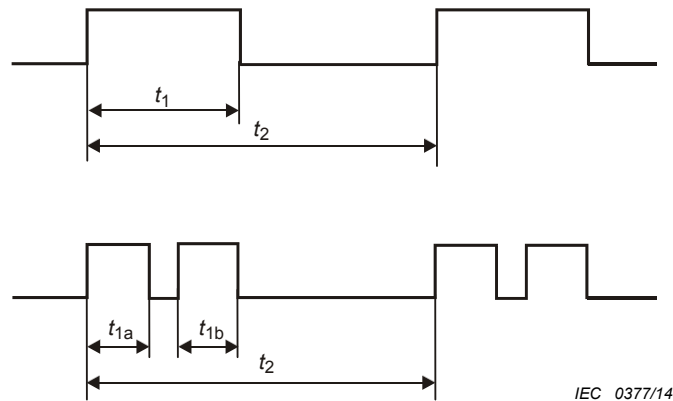

Key

t_1 is

- the duration of a single ringing period, where the ringing is active for the whole of the single ringing period;
- the sum of the active periods of ringing within the single ringing period, where the single ringing period contains two or more discrete active periods of ringing, as in the example shown, for which $t_1 = t_{1a} + t_{1b}$;

t_2 is the duration of one complete cadence cycle.

Figure H.1 – Definition of ringing period and cadence cycle

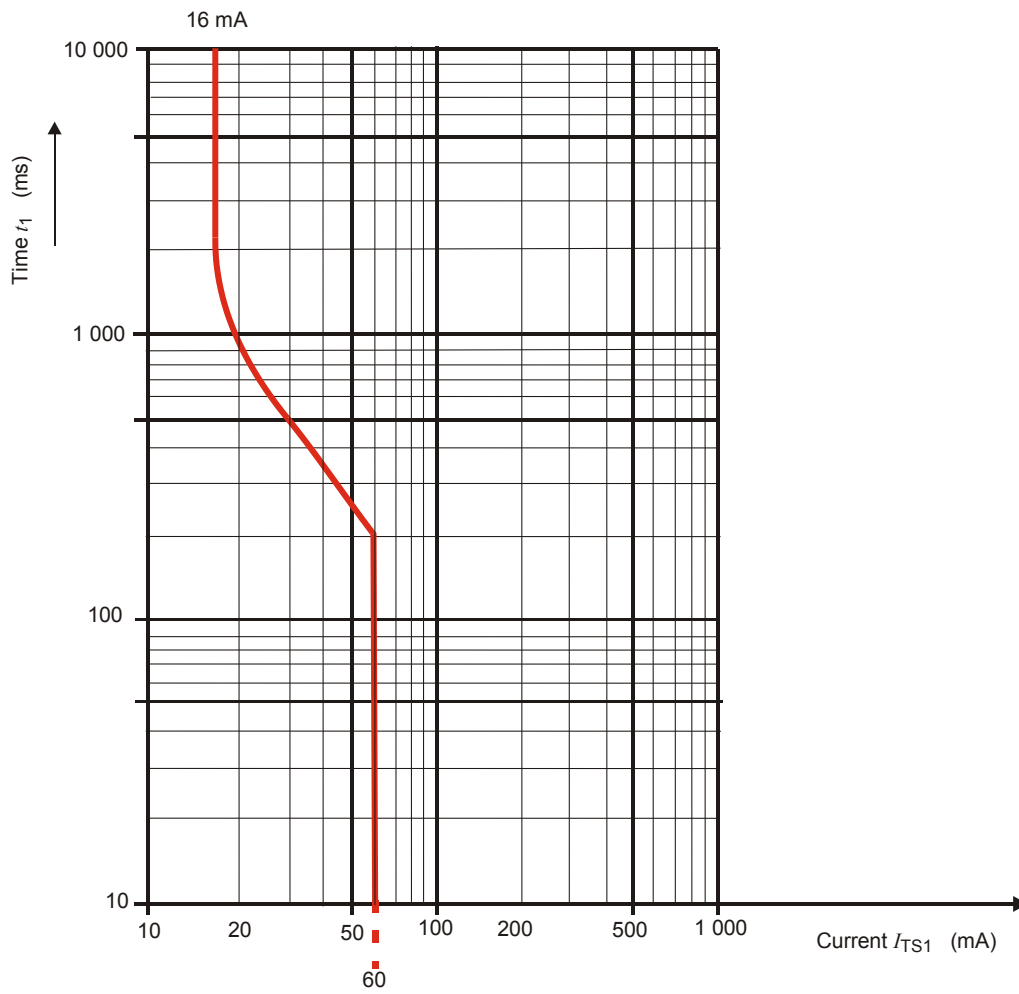

IEC 0378/14

Figure H.2 – I_{TS1} limit curve for cadenced ringing signal

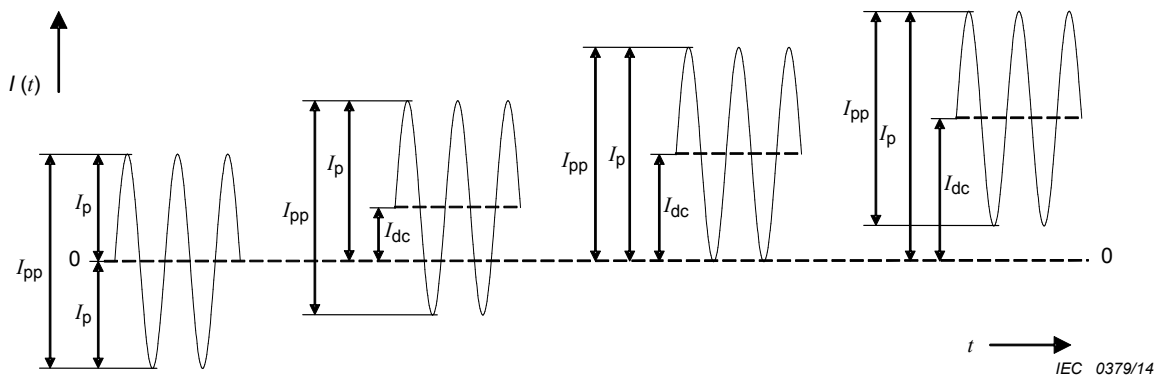

Figure H.3 – Peak and peak-to-peak currents

H.3 Method B

H.3.1 Ringing signal

H.3.1.1 Frequency

The ringing signal shall use only frequencies whose fundamental component is equal to or less than 70 Hz.

H.3.1.2 Voltage

The ringing voltage shall be less than 300 V peak-to-peak and less than 200 V peak with respect to earth, measured across a resistance of at least 1 M Ω .

H.3.1.3 Cadence

The ringing voltage shall be interrupted to create quiet intervals of at least 1 s duration separated by no more than 5 s. During the quiet intervals, the voltage to earth shall not exceed 60 V d.c.

H.3.1.4 Single fault current

Where cadenced ringing becomes continuous as a consequence of a single fault, the current through a 5 000 Ω resistor connected between any two output conductors or between one output conductor and earth shall not exceed 56,5 mA peak-to-peak, as shown in Figure H.3.

H.3.2 Tripping device and monitoring voltage

H.3.2.1 Conditions for use of a tripping device or a monitoring voltage

A ringing signal circuit shall include a tripping device as specified in H.3.2.2, or provide a monitoring voltage as specified in H.3.2.3, or both, depending on the current through a specified resistance connected between the ringing signal generator and earth, as follows:

- if the current through a 500 Ω or greater resistor does not exceed 100 mA peak-to-peak, neither a tripping device nor a monitoring voltage is required;
- if the current through a 1 500 Ω or greater resistor exceeds 100 mA peak-to-peak, a tripping device shall be included. If the tripping device meets the trip criteria specified in Figure H.4 with $R \geq 500 \Omega$, no monitoring voltage is required. If, however, the tripping device only meets the trip criteria with $R \geq 1 500 \Omega$, a monitoring voltage shall also be provided;
- if the current through a 500 Ω or greater resistor exceeds 100 mA peak-to-peak, but the current through a 1 500 Ω or greater resistor does not exceed this value, either:
 - a tripping device shall be provided, meeting the trip criteria specified in Figure H.4 with $R \geq 500 \Omega$, or
 - a monitoring voltage shall be provided.

NOTE 1 Tripping devices are, in general, current-sensitive and do not have a linear response, due to the resistance/current characteristics and time delay/response factor in their design.

NOTE 2 In order to minimize testing time, a variable resistor box is normally used.

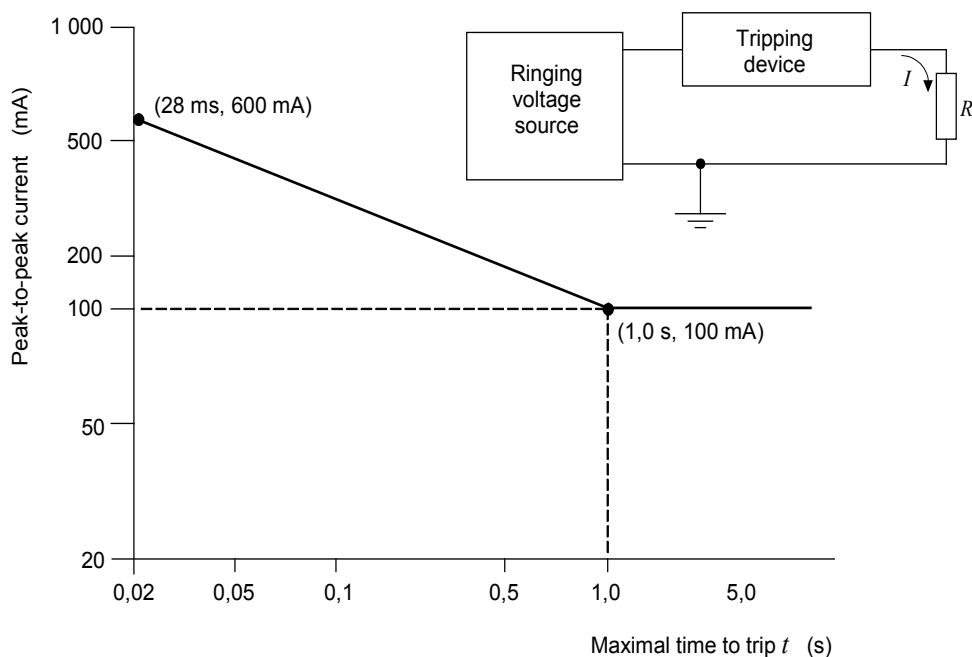

IEC 0380/14

NOTE 1 t is measured from the time of connection of the resistor R to the circuit.

NOTE 2 The sloping part of the curve is defined as $I = 100 / \sqrt{t}$.

Figure H.4 – Ringing voltage trip criteria

H.3.2.2 Tripping device

A series current-sensitive tripping device in the ringlead that will trip ringing as specified in Figure H.4.

H.3.2.3 Monitoring voltage

A voltage to earth on the tip or ring conductor with a magnitude of at least 19 V peak, but not exceeding 60 V d.c., whenever the ringing voltage is not present (idle state).

Annex I (informative)

Overvoltage categories (see IEC 60364-4-44)

The concept of overvoltage categories is used for equipment energized directly from the a.c. **mains**.

The largest transient voltage likely to be experienced at the power input interface of equipment connected to the **mains** is known as the **mains transient voltage**. In this standard, minimum **clearances** for insulation in circuits connected to the **mains** are based on the **mains transient voltage**.

According to IEC 60664-1, the value of the **mains transient voltage** is determined from the **mains** voltage and the overvoltage category, I to IV (see Table 13 of this standard).

The overvoltage category therefore shall be identified for each equipment intended to be connected to the **mains** (see Table I.1).

The overvoltage categories have a probabilistic implication rather than the meaning of physical attenuation of the transient voltage downstream in the installation.

NOTE 1 This concept of overvoltage categories is used in IEC 60364-4-44:2007, section 443.

NOTE 2 The term overvoltage category in this standard is synonymous with impulse withstand category used in IEC 60364-4-44:2007, section 443.

The term overvoltage category is not used in connection with d.c. power distribution systems in this standard.

Table I.1 – Overvoltage categories

Overvoltage category	Equipment and its point of connection to the a.c. mains	Examples of equipment
IV	Equipment that will be connected to the point where the mains supply enters the building	<ul style="list-style-type: none"> • Electricity meters • Communications ITE for remote electricity metering
III	Equipment that will be an integral part of the building wiring	<ul style="list-style-type: none"> • Socket outlets, fuse panels and switch panels • Power monitoring equipment
II	Pluggable or permanently connected equipment that will be supplied from the building wiring	<ul style="list-style-type: none"> • Household appliances, portable tools, home electronics • Most ITE used in the building
I	Equipment that will be connected to a special mains in which measures have been taken to reduce transients	<ul style="list-style-type: none"> • ITE supplied via an external filter or a motor driven generator

Annex J (normative)

Insulated winding wires for use without interleaved insulation

J.1 General

Requirements for winding wires whose insulation may be used to provide **basic insulation**, **supplementary insulation**, **double insulation** or **reinforced insulation** in wound components without interleaved insulation are specified below.

This annex applies to:

- solid round winding wires having diameters between 0,01 mm and 5,0 mm, and stranded winding wires with equivalent cross-sectional areas, and
- solid square and solid rectangular (flatwise bending) winding wires with cross-sectional areas of 0,000 079 mm² to 19,6 mm².

NOTE See G.6.1 for the minimum number of overlapping layers.

J.2 Type tests

J.2.1 General

*The winding wire shall pass the following **type tests**, carried out at a temperature between 15 °C and 35 °C and a relative humidity between 45 % and 75 %, unless otherwise specified.*

J.2.2 Electric strength

J.2.2.1 Solid round winding wires and stranded winding wires

J.2.2.1.1 Wires with a nominal conductor diameter up to and including 0,1 mm

The test specimen is prepared according to 4.3 of IEC 60851-5:2008. The specimen is then subjected to the electric strength test of 5.4.9.1, between the conductor of the wire and the cylinder, with a minimum test voltage of

- 3 kV r.m.s. or 4,2 kV peak for **reinforced insulation**, or
- 1,5 kV r.m.s. or 2,1 kV peak for **basic insulation** or **supplementary insulation**.

J.2.2.1.2 Wires with a nominal conductor diameter over 0,1 mm up to and including 2,5 mm

The test specimen is prepared according to 4.4.1 of IEC 60851-5:(twisted pair). The specimen is then subjected to the electric strength test of 5.4.9.1 with a test voltage that is not less than twice the appropriate voltage of 5.4.9.1, with a minimum of

- 6 kV r.m.s. or 8,4 kV peak for **reinforced insulation**, or
- 3 kV r.m.s. or 4,2 kV peak for **basic insulation** or **supplementary insulation**.

J.2.2.1.3 Wires with a nominal conductor diameter over 2,5 mm

The test specimen is prepared according to 4.5.1 of IEC 60851-5:2008. The specimen is then subjected to the electric strength test of 5.4.9.1 between the conductor of the wire and the shot, with a minimum test voltage of

- 3 kV r.m.s. or 4,2 kV peak for **reinforced insulation**, or

- 1,5 kV r.m.s. or 2,1 kV peak for **basic insulation** or **supplementary insulation**.

J.2.2.2 Square or rectangular wires

The test specimen is prepared according to 4.7.1 of IEC 60851-5:2008 (single conductor surrounded by metal shots). The specimen is then subjected to the electric strength test of 5.4.9.1, with a minimum test voltage of

- 3 kV r.m.s. or 4,2 kV peak for **reinforced insulation**, or
- 1,5 kV r.m.s. or 2,1 kV peak for **basic insulation** or **supplementary insulation**.

J.2.3 Flexibility and adherence

Clause 5.1 (in Test 8) of IEC 60851-3:2009 shall be used, using the mandrel diameters of Table J.1.

The test specimen is then examined in accordance with 5.1.1.4 of IEC 60851-3:2009, followed by the electric strength test of 5.4.9.1 in this standard, with minimum test voltage of

- 3 kV r.m.s. or 4,2 kV peak for **reinforced insulation**, or
- 1,5 kV r.m.s. or 2,1 kV peak for **basic insulation** or **supplementary insulation**.

The test voltage is applied between the wire and the mandrel.

Table J.1 – Mandrel diameter

Nominal conductor diameter or thickness mm	Mandrel diameter mm
less than 0,35	4,0 ± 0,2
less than 0,50	6,0 ± 0,2
less than 0,75	8,0 ± 0,2
less than 2,50	10,0 ± 0,2
less than 5,00	Four times the conductor diameter or thickness ^a
^a In accordance with IEC 60317-43.	

The tension to be applied to the wire during winding on the mandrel is calculated from the wire diameter to be equivalent to 118 MPa ± 10 % (118 N/mm² ± 10 %).

Edgewise bending on the smaller dimension side (width) is not required for rectangular wire.

For mandrel winding test of the square and rectangular wire, two adjacent turns do not need to contact each other.

J.2.4 Heat shock

The test specimen shall be prepared in accordance with 3.1.1 (in Test 9) of IEC 60851-6:1996, followed by the electric strength test of 5.4.9.1 in this standard, with a minimum test voltage of

- 3 kV r.m.s. or 4,2 kV peak for **reinforced insulation**, or
- 1,5 kV r.m.s. or 2,1 kV peak for **basic insulation** or **supplementary insulation**.

The test voltage is applied between the wire and the mandrel. The oven temperature is the relevant temperature of the thermal class of insulation in Table J.2. The mandrel diameter and tension applied to the wire during winding on the mandrel are as in Table J.1. The electric strength test is conducted at room temperature after removal from the oven.

Table J.2 – Oven temperature

Thermal class	Class 105 (A)	Class 120 (E)	Class 130 (B)	Class 155 (F)	Class 180 (H)	Class 200 (N)	Class 220 (R)	Class 250 -
Oven temperature °C	200	215	225	250	275	295	315	345
Oven temperatures shall be maintained within $\pm 5^\circ$ of the specified temperature. The classes are related to the classification of electrical insulating materials and EISs in accordance with IEC 60085. The assigned letter designations are given in parentheses.								

Edgewise bending on the smaller dimension side (width) is not required for rectangular wire.

NOTE Subclause 3.1.2 in Test 9 of IEC 60851-6:1996 is not used for solid square and solid rectangular winding wires.

J.2.5 Retention of electric strength after bending

Five specimens are prepared as in J.2.3 and tested as follows. Each specimen is removed from the mandrel, placed in a container and positioned so that it can be surrounded by at least 5 mm of metal shot. The ends of the conductor in the specimen shall be sufficiently long to avoid flash over. The shot shall be not more than 2 mm in diameter and shall consist of balls of stainless steel, nickel or nickel plated iron. The shot is gently poured into the container until the specimen under test is covered by at least 5 mm of shot. The shot shall be cleaned periodically with a suitable solvent.

NOTE The above test procedure is reproduced from 4.6.1 c) of IEC 60851-5, now withdrawn. It is not included in the fourth edition (2008) of that standard.

The specimen shall be subjected to the electric strength test of 5.4.9.1, with a minimum test voltage of

- 3 kV r.m.s. or 4,2 kV peak for **reinforced insulation**, or
- 1,5 kV r.m.s. or 2,1 kV peak for **basic insulation or supplementary insulation**.

The mandrel diameter and tension applied to the wire during winding on the mandrel are as in Table J.1.

J.3 Testing during manufacturing

J.3.1 General

The wire shall be subjected by the wire manufacturer to electric strength tests during manufacture as specified in J.3.2 and J.3.3.

J.3.2 Routine test

*The test voltage for **routine test** shall be in accordance with the electric strength test of 5.4.9.1, with a minimum of*

- 3 kV r.m.s. or 4,2 kV peak for **reinforced insulation**, or
- 1,5 kV r.m.s. or 2,1 kV peak for **basic insulation or supplementary insulation**.

J.3.3 Sampling test

*The **sampling test** shall be conducted according to the suitable test specified in J.2.2.*

Annex K (normative)

Safety interlocks

K.1 General

K.1.1 General requirements

Safety interlocks shall be so designed that, for an **ordinary person**, the class 2 energy sources and class 3 energy sources will be removed before the cover, door, etc. is in a position that those parts become **accessible** as a class 1 energy source.

Safety interlocks shall be so designed that, for an **instructed person**, the class 3 energy sources will be removed before the cover, door, etc. is in a position that this part becomes **accessible** as a class 2 energy source or less.

The interlock shall either:

- necessitate previous de-energization of such parts; or
- automatically initiate disconnection of the supply to such parts, and to reduce to a:
 - class 1 energy source within 2 s for an **ordinary person**, and
 - class 2 energy source within 2 s for an **instructed person**.

If reduction of the energy source class takes longer than 2 s, then an **instructional safeguard** shall be provided in accordance with Clause F.5, except that:

- element 1a shall be placed on the door, cover or other part that initiates the interlock action and is opened or removed to gain access; and
- element 3 is optional.

The elements of the **instructional safeguard** shall be as follows:

- element 1a: , IEC 60417-6057 (2011-05) for moving parts or



- element 2: not specified
- element 3: not specified
- element 4: the time when the energy source will be reduced to the required class

K.1.2 Test method and compliance criteria

The energy level of class 2 or class 3 energy source parts are monitored.

Compliance is checked by inspection, measurement and use of the rigid test finger according to Annex V.

K.2 Components of the safety interlock safeguard mechanism

The components comprising the **safety interlock** mechanism shall be considered **safeguards**, and shall comply with applicable **safeguard** requirements and shall be subject to applicable requirements of Annex G.

Compliance is checked in accordance with Annex G and by inspection.

K.3 Inadvertent change of operating mode

A **safety interlock** shall not be operable by means of probes specified in Figure V.1 or Figure V.2, as applicable so as to change the energy class within the area, space or access point being controlled to a class 3 energy source for an **instructed person**, or to a class 2 energy source or a class 3 energy source for an **ordinary person**.

Compliance is checked in accordance with Annex V and by inspection.

K.4 Interlock safeguard override

A **safety interlock** may be overridden by a **skilled person**. The **safety interlock** override system:

- shall require an intentional effort to operate; and
- shall reset automatically to normal operation when servicing is complete, or prevent normal operation unless the **skilled person** has carried out restoration; and
- if located in an area **accessible** to an **ordinary person** or, if applicable, an **instructed person**, shall not be operable by means of probes specified in Annex V, and shall require a **tool** for operation.

Compliance is checked in accordance with Annex V and by inspection.

K.5 Fail-safe

K.5.1 Requirement

In the event of any **single fault condition** in the **safety interlock** system, the space controlled by the **safety interlock** shall

- revert to a class 1 energy source for an **ordinary person** or a class 2 energy source for an **instructed person**, or
- be locked in the **normal operating condition** and comply with applicable requirements for a class 3 energy source.

K.5.2 Test method and compliance criteria

*Compliance is checked by introduction of electrical, electro-mechanical, and mechanical component faults, one at a time. **Single fault conditions** are described in Clause B.4. For each fault, the space controlled by the **safety interlock** shall comply with the applicable requirements for **single fault conditions** for the respective energy source. Fixed separation distances in **safety interlock** circuits (for example, those associated with printed boards) are not subjected to simulated **single fault conditions** if the separation distances comply with K.7.1.*

K.6 Mechanically operated safety interlocks

K.6.1 Endurance requirement

Moving mechanical parts in mechanical and electromechanical **safety interlock** systems shall have adequate endurance.

K.6.2 Test method and compliance criteria

*Compliance is checked by inspection of the **safety interlock** system, available data and, if necessary, by cycling the **safety interlock** system through 10 000 operating cycles. In the event of any fault during or after the 10 000 operating cycles in the **safety interlock** system, the space controlled by the **safety interlock** shall:*

- *revert to a class 1 energy source for an **ordinary person** or a class 2 energy source for an **instructed person**, or*
- *be locked in the **normal operating condition** and comply with applicable requirements for a class 3 energy source.*

NOTE The above test is conducted to check the endurance of moving parts other than those in **safety interlock** systems, switches and relays. **Safety interlock** systems, switches and relays, if any, are subject to Annex G.

K.7 Interlock circuit isolation

K.7.1 Separation distances for contact gaps and interlock circuit elements

If the switch or relay disconnects a circuit conductor in a circuit connected to the **mains**, the separation distances for contact gaps and their related circuits shall be not less than that for a **disconnect device** (see Annex L).

If the switch or relay is in a circuit isolated from the **mains**, the separation distances for contact gaps shall be not less than the relevant minimum **clearance** value for **basic insulation** for isolation of class 2 energy sources. Interlock circuit elements, the failure of which can defeat the interlock system, shall have **basic insulation**.

If the switch or relay is in a circuit isolated from the **mains**, the separation distances for contact gaps shall be not less than the relevant minimum **clearance** value for **reinforced insulation** for isolation of class 3 energy sources. Interlock circuit elements, the failure of which can defeat the interlock system, shall have **reinforced insulation**.

Two independent interlock systems using **basic insulation** may be used as an alternative to the provision of **reinforced insulation**.

Alternatively, the separation gap between contacts in the off position shall withstand the electric strength test of 5.4.9.1 at a test voltage required for **basic insulation** or **reinforced insulation**, as applicable. The contact gap shall comply with the above requirements before and after the 10 000 cycle endurance test of K.6.2. The endurance test condition shall represent the maximum **normal operating condition** within the equipment with respect to voltage and current that the contacts interrupt.

The contact gap **clearance** shall comply with the applicable distance from Table 15, provided the switch or relay complies with K.7.2, K.7.3 and K.7.4.

K.7.2 Overload test

*The contact of a switch or relay in the **safety interlock** system is subjected to an overload test consisting of 50 cycles of operation at the rate of 6 to 10 cycles per minute, making and breaking 150 % of the current imposed in the application, except that where a switch or relay*

contact switches a motor load, the test is conducted with the rotor of the motor in a locked condition.

*After the test, the **safety interlock** system, including the switch or relay, shall still be functional.*

K.7.3 Endurance test

*The contact of a switch or relay in the **safety interlock** system is subjected to an endurance test, making and breaking 100 % of the current imposed in the application at a rate of 6 to 10 cycles of operation per minute. A higher rate of cycling may be used if requested by the manufacturer.*

*For reed switches used in a **safety interlock** system in ES1 or ES2, the test is 100 000 operating cycles. For other switches and relays in a **safety interlock** system, the test is 10 000 operating cycles.*

*After the test, the **safety interlock** system, including the switch or relay, shall still be functional.*

K.7.4 Electric strength test

*Except for reed switches in ES1 or ES2, an electric strength test as specified in 5.4.9.1 is applied between the contacts after the tests of K.7.3. If the contact is in a circuit connected to the **mains**, the test voltage is as specified for **reinforced insulation**. If the contact is in a circuit isolated from the **mains**, the test voltage is as specified for **basic insulation** in a circuit connected to the **mains**.*

Annex L (normative)

Disconnect devices

L.1 General requirements

A **disconnect device** shall be provided to disconnect the equipment from the supply. If a **disconnect device** interrupts the neutral conductor, it shall simultaneously interrupt all phase conductors.

A **disconnect device** may be:

- the plug on the power supply cord; or
- an appliance coupler; or
- an isolating switch; or
- a circuit breaker; or
- any equivalent means for disconnection.

For equipment intended to be powered from an a.c. **mains** that is overvoltage category I, overvoltage category II or overvoltage category III, or from a d.c. **mains** that is ES3, a **disconnect device** shall have a contact separation of at least 3 mm. For an a.c. **mains** that is overvoltage category IV, IEC 60947-1 shall apply. When incorporated in the equipment, the **disconnect device** shall be connected as closely as practicable to the incoming supply.

For equipment intended to be powered from a d.c. **mains** that is not at ES3,

- a **disconnect device** shall have a contact separation at least equal to the minimum **clearance** for **basic insulation**;
- a removable fuse may be used as a **disconnect device**, provided that it is **accessible** only to an **instructed person** or to a **skilled person**.

L.2 Permanently connected equipment

For **permanently connected equipment** the **disconnect device** shall be incorporated in the equipment, unless the equipment is accompanied by installation instructions stating that an appropriate **disconnect device** shall be provided as part of the building installation.

NOTE External **disconnect devices** will not necessarily be supplied with the equipment.

L.3 Parts that remain energized

Parts on the supply side of a **disconnect device** in the equipment, that remain energized when the **disconnect device** is switched off, shall be guarded to reduce the risk of accidental contact by **skilled persons**.

As an alternative, instructions shall be provided in the service manual.

L.4 Single-phase equipment

For single-phase equipment, the **disconnect device** shall disconnect both poles simultaneously, except that a single-pole **disconnect device** can be used to disconnect the phase conductor when it is possible to rely on the identification of the neutral in the **mains**. If

only a single pole **disconnect device** is provided in the equipment, instructions shall be given for the provision of an additional two-pole **disconnect device** in the building installation when the equipment is used where identification of the neutral in the **mains** is not possible.

EXAMPLE Cases where a two-pole **disconnect device** is required are:

- on equipment supplied from an IT power system;
- on pluggable equipment supplied through a reversible appliance coupler or a reversible plug (unless the appliance coupler or plug itself is used as the **disconnect device**;
- on equipment supplied from a socket-outlet with indeterminate polarity.

L.5 Three-phase equipment

For three-phase equipment, the **disconnect device** shall disconnect simultaneously all phase conductors of the supply. For equipment requiring a neutral connection to an IT power system, the **disconnect device** shall be a four-pole device and shall disconnect all phase conductors and the neutral conductor. If this four-pole device is not provided in the equipment, the installation instructions shall specify the need for its provision as part of the building installation.

L.6 Switches as disconnect devices

Where the **disconnect device** is a switch incorporated in the equipment, the on and off positions shall be marked in accordance with F.3.5.2.

L.7 Plugs as disconnect devices

Where a plug on the power supply cord is used as the **disconnect device**, the installation instructions shall state that for pluggable equipment, the socket-outlet shall be easily **accessible**. For pluggable equipment intended for installation by an **ordinary person**, the installation instructions shall be made available to the **ordinary person**.

L.8 Multiple power sources

Where a unit receives power from more than one source (for example, different voltages/frequencies or as redundant power), there shall be a prominent **instructional safeguard** in accordance with Clause F.5 at each **disconnect device** giving adequate instructions for the removal of all power from the unit.

The elements of the **instructional safeguard** shall be as follows:

- element 1a: , IEC 60417-6042 (2010-11); and



- element 2: “Caution” or equivalent word or text, and “Shock hazard” or equivalent text
- element 3: optional
- element 4: “Disconnect all power sources” or equivalent text

If more than one such **disconnect device** is provided on a unit, all these devices shall be grouped together. It is not necessary that the devices be mechanically linked.

Equipment incorporating an internal UPS shall have provisions for reliably disabling the UPS and disconnecting its output prior to servicing the equipment. Instructions for disconnection of the UPS shall be provided. The internal energy source of the UPS shall be marked appropriately and guarded against accidental contact by a **skilled person**.

L.9 Compliance criteria

Compliance is checked by inspection.

Annex M (normative)

Equipment containing batteries and their protection circuits

M.1 General requirements

This annex provides additional requirements for equipment that contains **batteries**. Use of **batteries** in the equipment may require **safeguards** that have not been addressed in other parts of the standard. This annex does not cover requirements for external **batteries**, installation of external **batteries** or **battery** maintenance other than **battery** replacement by an **ordinary person** or an **instructed person**. Also, this annex does not cover equipment that charges external **batteries**.

Where a **battery** safety standard contains equivalent requirements to the requirements in this annex, a **battery** in compliance with that **battery** standard is considered to fulfil the corresponding requirements of this annex, and tests that are part of the **battery** safety standard need not be repeated under this annex.

For equipment containing a **battery** that is replaceable by an **ordinary person**, an **instructional safeguard** shall be provided in accordance with Clause F.5, except that the complete **instructional safeguard** may be provided in the instructions.

The elements of the **instructional safeguard** shall be as follows:

- element 1a: not available
- element 2: “CAUTION” or equivalent word or text
- element 3: “Risk of explosion if the battery is replaced by an incorrect type” or equivalent text
- element 4: optional

M.2 Safety of batteries and their cells

M.2.1 Requirements

Batteries and their **cells** shall comply with the relevant IEC standards for **batteries** as listed below.

IEC 60086-4, IEC 60086-5, IEC 60896-11, IEC 60896-21, IEC 60896-22, IEC 61056-1 and IEC 61056-2, IEC 61427, IEC/TS 61430, IEC 61434, IEC 61959, IEC 62133, IEC 62281, and IEC 62485-2.

NOTE Other **battery** safety standards are under development, and are intended to be included in future.

M.2.2 Compliance criteria

Compliance is checked by inspection or evaluation based on data provided by the manufacturer.

M.3 Protection circuits for batteries provided within the equipment

M.3.1 Requirements

Protection circuits for **batteries** provided within the equipment and that are not an integral part of the **battery** shall be so designed that:

- **safeguards** are effective during **normal operating conditions**, **abnormal operating conditions**, **single fault conditions**, installation conditions and transportation conditions; and
- the output characteristics of a **battery** charging circuit are compatible with its rechargeable **battery**; and
- for non-rechargeable **batteries**, discharging at a rate exceeding the **battery** manufacturer's recommendations and unintentional charging are prevented; and
- for rechargeable **batteries**, charging and discharging at a rate exceeding the **battery** manufacturer's recommendations, and reversed charging are prevented; and
- **batteries** in **hand-held equipment**, **direct plug-in equipment** and **transportable equipment** that are replaceable by an **ordinary person** shall be inherently protected to avoid creating a class 2 energy source or a class 3 energy source.

NOTE Reversed charging of a rechargeable **battery** occurs when the polarity of the charging circuit is reversed, aiding the discharge of the **battery**.

M.3.2 Test method

*Protection circuits for **batteries** are checked by inspection and by evaluation of the data provided by the equipment manufacturer and **battery** manufacturer for charging and discharging rates.*

*When appropriate data is not available, compliance is checked by test. However, **batteries** that are inherently safe for the conditions given are not tested under those conditions. Consumer grade, non-rechargeable carbon-zinc or alkaline **batteries** are considered safe under short-circuiting conditions and therefore are not tested for discharge; nor are such **batteries** tested for leakage under storage conditions.*

*The **battery** used for the following tests is either a new non-rechargeable **battery** or a fully charged rechargeable **battery** as provided with the equipment, or recommended by the manufacturer for use with the equipment. The test for **battery** protection circuits in the equipment may be performed using a **battery** simulator replacing the **battery** itself. The temperature test is conducted in a temperature controlled chamber. A control signal simulating the actual signal from the temperature sensor in the **battery** may be used in order to perform the test.*

- *Overcharging of a rechargeable **battery**. The **battery** is charged while briefly subjected to the simulation of any **single fault condition** that is likely to occur in the charging circuit and that results in overcharging of the **battery**. To minimize testing time, the failure is chosen that causes the worst-case overcharging condition. The **battery** is then charged for a single period of 7h with the simulated failure in place.*
- *Excessive discharging. The **battery** is subjected to rapid discharge by open-circuiting or short-circuiting any current limiting or voltage limiting component in the load circuit of the **battery** under test (one component at a time).*

*Where more than one **cell** is provided in a **battery**, all **cells** shall be tested as a unit.*

NOTE Some of the tests specified can be hazardous to the persons performing the tests. Use appropriate measures to protect such persons against possible chemical or **explosion** hazards.

*For equipment where the **battery** can be removed from the equipment by an **ordinary person**, the following additional tests apply:*

- *Reverse charging of a rechargeable **battery**. Check whether the equipment containing a **battery** has such construction design that the **battery** may be placed into the equipment in the manner causing reverse charging. Also it will be checked if the electrical connection is made. If a reverse charging is judged possible by the inspection, the following test is applied. However, when relevant IEC **battery** standards cover this requirement in the Annex, the test is considered to be performed.*

*The **battery** is installed in the reverse orientation and then the charging circuit is subject to simulation of any single component failure. To minimize testing time, the failure is chosen that causes the highest reverse charging current. The **battery** is then reverse charged for a single period of 7 h with the simulated failure in place.*

- *Unintentional charging of a non-rechargeable **battery**. The **battery** is charged while briefly subjected to the simulation of any single component failure that is likely to occur in the charging circuit and that would result in unintentional charging of the **battery**. To minimize testing time, the failure is chosen that causes the highest charging current. The **battery** is then charged for a single period of 7 h with the simulated failure in place.*

M.3.3 Compliance criteria

These tests shall not result in any of the following:

- *chemical leakage caused by cracking, rupturing or bursting of the **battery** jacket, if such leakage could adversely affect a **safeguard**; or*
- *spillage of liquid from any pressure relief device in the **battery**, unless such spillage is contained by the equipment without risk of damage to a **safeguard** or harm to an **ordinary person** or an **instructed person**; or*
- ***explosion** of the **battery**, if such **explosion** could result in injury to an **ordinary person** or an **instructed person**; or*
- *emission of flame or expulsion of molten metal to the outside of the equipment **enclosure**.*

Throughout the tests:

- *the **battery** temperature shall not exceed the allowable temperature of the **battery** as specified by the **battery** manufacturer; and*
- *the maximum current drawn from the **battery** shall be within the range of the specification of the **battery**.*

M.4 Additional safeguards for equipment containing a secondary lithium battery

M.4.1 General

Equipment designed to be operated while incorporating one or more portable sealed **secondary lithium batteries** are subject to the requirements in this clause.

M.4.2 Charging safeguards

M.4.2.1 Requirements

Under **normal operating conditions**, **abnormal operating conditions** or **single fault conditions** the charging voltage per **secondary lithium battery** and the charging current per **secondary lithium battery** shall not exceed the **maximum specified charging voltage** and **maximum specified charging current**.

The **battery** charging circuit shall stop charging when the temperature of the **battery** exceeds the **highest specified charging temperature**. The **battery** charging circuit shall limit the current to the value specified by the **battery** manufacturer when the **battery** temperature is lower than the **lowest specified charging temperature**.

M.4.2.2 Compliance criteria

Compliance is checked by measuring the charging voltage, the charging current and the temperature of each individual **cell** of the **secondary lithium battery** under **normal operating conditions**, **abnormal operating conditions** and **single fault conditions**. The **cell temperature** shall be measured at the points specified by the **battery manufacturer**. **Single fault conditions** that may affect the charging voltage or charging current or the temperature shall be applied in accordance with Clause B.4.

NOTE 1 For potted assemblies, thermocouples could be attached to the **cell** surface before potting.

A higher charging voltage than the **maximum specified charging voltage** or a higher charging current than the **maximum specified charging current**, that occurs just after the introduction of an **abnormal operating condition** or a **single fault condition**, may be ignored if the operation of a protective device or circuitry, provided in addition to the normal regulating circuitry, prevents an unsafe condition of the **battery**.

Where appropriate, for the purpose of the measurement, the **battery** may be replaced by a circuit simulating the **battery** load.

The charging voltage shall be measured when the **secondary lithium battery** becomes fully charged. The charging current shall be measured during the entire charging cycle up to the **maximum specified charging voltage**.

During and after the test, no fire or **explosion** (other than venting) of **secondary lithium battery** shall occur. The charging voltage shall not exceed **maximum specified charging voltage**. The charging current shall not exceed **maximum specified charging current**. The charging of the **battery** shall be stopped when the temperature of the **battery** exceeds the **highest specified charging temperature**. The **battery** charging circuit shall limit the current to the value specified by the **battery** manufacturer when the **battery** temperature is lower than the **lowest specified charging temperature**.

NOTE 2 Venting without flame, fire or expulsion of solid materials is a **safeguard** of a **secondary lithium battery**.

In addition, for equipment where the **battery** can be removed from the equipment by an **ordinary person**, compliance is checked by measuring the charging voltage and the charging current, and by evaluating the temperature control function of the equipment under **normal operating conditions**, **abnormal operating conditions** and **single fault conditions**.

All parameters controlled by the protection circuit for the **battery** shall be within those specified in the relevant IEC **battery** standard, and shall cover the following:

- the maximum current drawn from the **battery** shall be within the range of the specification of the **battery**; and
- throughout the tests, the **battery** temperature shall not exceed the allowable temperature of the **battery** as specified by the **battery** manufacturer.

NOTE 3 The controlling elements are voltage, current, and temperature.

M.4.3 Fire enclosure

Secondary lithium battery shall be provided with a **fire enclosure** according to 6.4.8. The **fire enclosure** may be that of the **secondary lithium battery** itself or that of the equipment containing the **secondary lithium battery**.

Equipment with **batteries** are exempted from the above requirement, provided that:

- the **battery** complies with PS1 circuit limits; or

- the equipment with the **battery** complies with the **supplementary safeguard** requirements of 6.4.5.2.

*Compliance is checked by inspection of the relevant material or by evaluation of the **secondary lithium battery** datasheet.*

M.4.4 Drop test of equipment containing a secondary lithium battery

M.4.4.1 General

The tests for **direct plug-in equipment**, **hand-held equipment** and **transportable equipment** that contain a **secondary lithium battery** are specified below. These test are specified to verify that mechanical shock will not compromise a **safeguard** within the **battery** or the equipment.

M.4.4.2 Preparation and procedure for the drop test

The drop test is conducted in the following order:

- *Step 1: drop of the equipment containing a **battery** as specified in M.4.4.3*
- *Step 2: check the charge and discharge function of the dropped equipment as specified in M.4.4.4*
- *Step 3: conduct a charge and discharge cycle test of the dropped **battery** as specified in M.4.4.5*

*As a preparation of the drop test, two **batteries** are fully charged at the same time under the same charging conditions. The open circuit voltages of both **batteries** are measured to confirm the initial voltages are the same. One **battery** is used for the drop test and the other is used as a reference.*

M.4.4.3 Drop

*The equipment with a fully charged **battery** installed shall be subjected to the drop test of Clause T.7.*

*After the drop test, the **battery** is removed from the equipment. The open circuit voltages of the dropped **battery** and the reference (undropped) **battery** are periodically monitored during the following 24 hour period. The voltage difference shall not exceed 5%.*

M.4.4.4 Check of the charge/discharge function

*The charging/discharging circuit functions (charging- control voltage, charging control current, and temperature control) are checked to determine that they continue to operate and that all **safeguards** are effective. A dummy **battery** or appropriate measurement tool that represents the **battery** characteristics may be used for this examination in order to differentiate between **battery** damage and equipment malfunctions.*

If the charge/discharge function does not operate, the test is terminated, continuation with step 3 is not necessary and compliance is determined by M.4.4.6.

M.4.4.5 Charge / discharge cycle test

*If the dropped equipment is still functioning, the dropped equipment with the dropped **battery** installed is subject to three complete discharge and charge cycles under **normal operating conditions**.*

M.4.4.6 Compliance criteria

*During the tests, fire or **explosion** of the **battery** shall not occur unless an appropriate **safeguard** is provided that contains the **explosion** or fire. If venting occurs, any electrolyte leakage shall not defeat a **safeguard**.*

*When a protection circuitry for charging or discharging in the equipment or the **battery** detects an abnormality in the **battery** and stops charging or discharging, the result is considered to be acceptable.*

M.5 Risk of burn due to short-circuit during carrying

M.5.1 Requirements

Battery terminals shall be protected from the possible burn that may occur to an **ordinary person** or an **instructed person** during the carrying of a **battery** with exposed bare conductive terminals (such as in the user's carrying bag) due to a short-circuit caused by metal objects, such as clips, keys and necklaces.

M.5.2 Test method and compliance criteria

*If the **battery** is designed to be carried with bare conductive terminals, the **battery** shall comply with the test of P.2.3.*

The compliance criteria of M.3.3 apply.

M.6 Prevention of short-circuits and protection from other effects of electric current

M.6.1 Short-circuits

M.6.1.1 General requirements

The electric energy stored in **cells** or **batteries** may be released in an inadvertent and uncontrolled manner due to external short-circuiting of the terminals or an internal **safeguard** failure, such as a metal contaminant bridging the insulation. As a result, the considerable amount of energy, heat and pressure generated by the high current can produce molten metal, sparks, **explosion** and vaporisation of electrolyte.

To address external faults, the main connections from the **battery** terminals shall either:

- be provided with a sufficient overcurrent protective device to prevent any accidental short-circuit inducing conditions as mentioned above; or
- the **battery** connections up to the first overcurrent protective device shall be constructed so that a short-circuit is not likely to occur and connections shall be designed to withstand the electromagnetic forces experienced during a short-circuit.

NOTE 1 Where terminals and conductors are not insulated, by design or for maintenance purposes, only insulated **tools** are to be used in that area.

Unless internal fault testing has been conducted on the **battery** as part of compliance with an IEC **battery** standard in M.2.1, the internal fault testing as described below is required.

NOTE 2 Not all **battery** standards in M.2.1 contain a similar internal fault test.

Each **cell** in a **battery** shall be faulted to ensure that each **cell** vents safely without introducing an **explosion** or fire. Where a **cell** is incorporated into a **battery** or the equipment, sufficient spacing shall be allowed for the proper vent operation of each **cell**.

M.6.1.2 Compliance criteria

For external faults, compliance may be checked by inspection.

The sample shall not explode or emit molten material at any time during any of the tests.

M.6.2 Leakage currents

To be resistant against effects of ambient influences like temperature, dampness, dust, gasses, steam, mechanical stress, and to avoid the risk of fire or corrosion, **batteries** shall be kept clean and dry.

The **battery** system should be isolated from the fixed installation before this measurement is carried out.

NOTE Before carrying out any test, consider the presence of ES2 or ES3 voltages between the **battery** and the associated rack or **enclosure**.

*Compliance is checked by measuring the insulation resistance between the **battery's** circuit and other local conductive parts. The insulation resistance shall be greater than 100 Ω per volt (of **battery** nominal voltage), corresponding to a leakage current less than 10 mA.*

M.7 Risk of explosion from lead acid and NiCd batteries

M.7.1 Ventilation preventing an explosive gas concentration

Where **batteries** are provided within an equipment such that emitted gases may concentrate in a confined equipment space, the **battery** construction, air flow or ventilation shall be such that the atmosphere within the equipment does not reach an **explosive** concentration.

Clause M.7 is applied for open type **batteries** and valve regulated type **batteries**. Sealed type **batteries** with a mechanism of reducing gas are considered to comply with this requirement.

M.7.2 Test method and compliance criteria

*The purpose of ventilating a **battery** location or **enclosure** is to maintain the hydrogen concentration below the **explosive** 4 %_{vol} hydrogen LEL threshold. The hydrogen concentration in the **battery** location shall not exceed 1 %_{vol} hydrogen.*

NOTE 1 When a **cell** reaches its fully charged state, water electrolysis occurs according to the Faraday's law.

Under standard conditions of normal temperature and pressure where $T = 273\text{ K}$, $P = 1\,013\text{ hPa}$:

- 1 Ah decomposes H_2O into 0,42 l H_2 + 0,21 l O_2 ,
- decomposition of 1 cm³ (1 g) H_2O requires 3 Ah,
- 26,8 Ah decomposes H_2O into 1 g H_2 + 8 g O_2 .

*When the charging operation is stopped, the emission of gas from the **cells** can be regarded as having come to an end 1 h after having switched off the charging current.*

*The minimum air flow rate for ventilation of a **battery** location or compartment shall be calculated by the following formula:*

$$Q = v \times q \times s \times n \times I_{\text{gas}} \times C_{\text{rt}} \times 10^{-3} \quad \left[\text{m}^3 / \text{h} \right]$$

where

Q is the ventilation air flow in m^3/h ;

v is the necessary dilution of hydrogen:

$$\frac{(100 - 4)\%}{4\%} = 24;$$

$q = 0,42 \times 10^{-3} \left[\text{m}^3/\text{Ah} \right]$ generated hydrogen;

$s = 5$, general safety factor;

n is the number of **cells**;

I_{gas} is the current producing gas in mA / Ah rated capacity for the float charge current I_{float} or the boost charge current I_{boost} ;

C_{rt} is the capacity C_{10} for lead acid **cells** (Ah) or capacity C_5 for NiCd **cells** (Ah)

NOTE 2 C_{10} is the 10 h rate with current I_{10} for lead acid **cells**: (Ah) to $U_{\text{final}} = 1,80 \text{ V/cell}$ at $20 \text{ }^\circ\text{C}$

C_5 is the 5h rate with current I_5 for NiCd **cells**: (Ah) to $U_{\text{final}} = 1,00 \text{ V/cell}$ at $20 \text{ }^\circ\text{C}$

with $v \times q \times s = 0,05 \left[\text{m}^3/\text{Ah} \right]$ the ventilation air flow calculation formula is:

$$Q = 0,05 \times n \times I_{\text{gas}} \times C_{\text{rt}} \times 10^{-3} \left[\text{m}^3 / \text{h} \right]$$

The current I_{gas} in mA producing gas is determined by one of the following formulas:

$$I_{\text{gas}} = I_{\text{float}} \times f_g \times f_s \left[\text{mA}/\text{Ah} \right] \text{ or}$$

$$I_{\text{gas}} = I_{\text{boost}} \times f_g \times f_s \left[\text{mA}/\text{Ah} \right]$$

where

I_{gas} is the current producing gas in mA / Ah rated capacity for the float charge current I_{float} or the boost charge current I_{boost} ;

I_{float} is the float charge current under fully charged condition at a defined float charge voltage at $20 \text{ }^\circ\text{C}$;

I_{boost} is the boost charge current under fully charged condition at a defined boost charge voltage at $20 \text{ }^\circ\text{C}$;

f_g is the gas emission factor, proportion of current at fully charged state producing hydrogen (see Table M.1);

f_s is the safety factor, to accommodate faulty **cells** in a **battery** and an aged **battery** (see Table M.1).

Table M.1 – Values of f_g and f_s

	Lead-acid batteries vented cells Sb < 3 %	Lead-acid batteries VRLA cells	NiCd batteries vented cells
gas emission factor f_g	1	0,2	1
gas emission safety factor f_s (including 10 % faulty cells and ageing)	5	5	5

For outdoor equipment, Clause 11 of IEC 60950-22:2005 applies.

M.8 Protection against internal ignition from external spark sources of batteries with aqueous electrolyte

M.8.1 General

The requirements specified below apply to rechargeable **batteries** providing a venting system.

NOTE For example, a **battery** used in a UPS.

The level of air ventilation rate shall ensure that a risk of **explosion** does not exist by keeping the hydrogen content in air below 1 %_{vol} at the **PIS**.

The use of an effective flame arrester in the **battery** venting system will prevent an external **explosion** propagating into the **battery**.

Clause M.8 is applied for open type **batteries** and valve regulated type **batteries**. Sealed type **batteries** with a mechanism of reducing gas are considered to comply with this requirement.

M.8.2 Test method

M.8.2.1 General

The test shall be carried out according to IEC 60896-21:2004, 6.4.

NOTE 1 This test is designed to reveal the protection afforded by the valve unit against the ignition of the gases within a **cell** by an external ignition source. During this test, use proper precautions to **safeguard** persons and equipment from **explosion** and burns.

A minimum distance d extending through air shall be maintained within which a maximum surface temperature of 300 °C shall not be exceeded (no flames, sparks, arcs or glowing devices).

NOTE 2 When calculating the minimum distance d to protect against **explosion** in close proximity to the source of release of a **cell** or **battery**, the dilution of **explosive** gases is not always ensured. The dispersion of **explosive** gas depends on the gas release rate and the ventilation characteristics close to the source of release.

*The minimum distance d can be estimated by calculating the dimensions of a hypothetical volume V_z of potentially **explosive** gas around the source of release, outside of which the concentration of hydrogen is below the safe concentration of the LEL.*

$$d = 28,8 \times \sqrt[3]{I_{\text{gas}}} \times \sqrt[3]{C_{\text{rt}}} \quad [\text{mm}]$$

where

I_{gas} is the current producing gas [mA / Ah];

C_{rt} is the rated capacity [Ah].

NOTE 3 The required distance d can be achieved by the use of a partition wall between the **battery** and sparking device.

*Where **batteries** form an integral part of a power supply system (for example, in a UPS system), the distance d , where d is the minimum distance (**clearance**) between the ventile of the **battery** and the electronic equipment that may exhibit flames, sparks, arcs or glowing devices (maximum surface temperature 300 °C), may be reduced according to the equipment manufacturer's calculations or measurements. The level of air ventilation rate should ensure*

that a risk of **explosion** does not exist by keeping the hydrogen content in air below 1%_{vol} plus a margin at the **PIS**.

M.8.2.2 Estimation of hypothetical volume V_z

The theoretical minimum ventilation flow rate to dilute the flammable gas (hydrogen) to a concentration below the LEL can be calculated by means of the formula:

$$\left(\frac{dV}{dt}\right)_{\min} = \frac{(dG/dt)_{\max}}{k \times \text{LEL}} \times \frac{T}{293}$$

where

- dV/dt_{\min} is the minimum volumetric flow rate of fresh air required to dilute the gas (m^3/s);
- dG/dt_{\max} is the maximum gas release rate (kg/s);
- LEL is 4 %_{vol} for hydrogen (kg/m^3);
- k is the factor applied to the LEL; $k = 0,25$ is chosen for dilution of hydrogen gas;
- T is the ambient temperature in K (293 Kelvin = 20 °C).

The volume V_z represents the volume over which the mean concentration of flammable gas will be 0,25 times the LEL. This means that at the extremities of the hypothetical volume, the concentration of gas will be significantly below the LEL (for example, the hypothetical volume where the concentration is above LEL would be less than V_z).

M.8.2.3 Correction factors

With a given number of air changes per unit time, c , related to the general ventilation the hypothetical volume V_z of potentially **explosive** atmosphere around the source of release can be estimated as follows:

$$V_z = \left(\frac{dV}{dt}\right)_{\min} / c$$

where c is the number of fresh air changes per unit time (s^{-1}).

The above formula holds for an instantaneous and homogenous mixing at the source of release given ideal flow conditions of fresh air. In practice, ideal conditions rarely exist. Therefore a correction factor f is introduced to denote the effectiveness of the ventilation.

$$V_z = f \times \left(\frac{dV}{dt}\right)_{\min} / c$$

where f is the ventilation effectiveness factor, denoting the efficiency of the ventilation in terms of its effectiveness in diluting the **explosive** atmosphere, f ranging from 1 (ideal) to typically 5 (impeded air flow). For **battery** installations the ventilation effectiveness factor is $f = 1,25$.

M.8.2.4 Calculation of distance d

The term $\left(\frac{dV}{dt}\right)_{\min}$

including all factors corresponds with the hourly ventilation air flow Q (in m^3/h) for secondary **batteries** calculated under

$$Q = f \times \left(\frac{dV}{dt} \right)$$

$$Q = 0,05 \times (N) \times I_{\text{gas}} \times C_{\text{rt}} \times 10^{-3} \quad [\text{m}^3/\text{h}]$$

This hourly ventilation air flow Q can be used to define a hypothetical volume. Assuming a hemispherical dispersal of gas, a volume of a hemisphere $V_z = 2/3 \pi d^3$ can be defined, where d is the distance from the source of release.

This results in the calculation formula for the distance d , with $c = 1$ air change per hour within the hemisphere:

$$d^3 = \frac{3}{2\pi} \times 0,05 \times 10^6 \times (N) \times I_{\text{gas}} \times C_{\text{rt}} \quad [\text{mm}^3]$$

$$d = 28,8 \times \sqrt[3]{N} \times \sqrt[3]{I_{\text{gas}}} \times \sqrt[3]{C_{\text{rt}}} \quad [\text{mm}]$$

Depending on the source of gas release, the number of **cells** per monobloc **battery** (N) or vent openings per **cell** involved ($1/N$) shall be taken into consideration (for example, by the factor $\sqrt[3]{N}$, respectively $\sqrt[3]{1/N}$).

The distance d as a function of the rated capacity for various charge currents I (mA/Ah) is shown in Figure M.1.

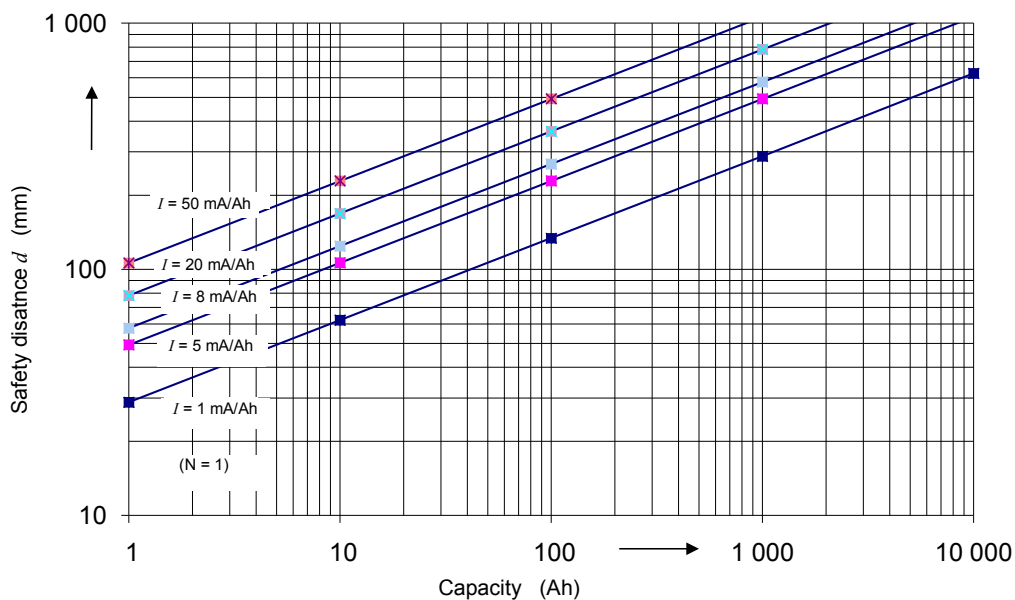

IEC 0381/14

Figure M.1 – Distance d as a function of the rated capacity for various charge currents I (mA/Ah)

M.9 Preventing electrolyte spillage

M.9.1 Protection from electrolyte spillage

Equipment shall be constructed so that spillage of electrolyte from **batteries**, that may have an adverse effect on skin, eye and other human body parts, other **safeguards** or the premises, is unlikely. All possible operating modes during maintenance should be taken into account, including replacement of the **battery** and refilling of consumed material.

Compliance is checked by inspection.

M.9.2 Tray for preventing electrolyte spillage

If **cell** failure could result in the spillage of electrolyte, the spillage shall be contained (for example, by use of a retaining tray adequate to contain the electrolyte) taking into account the maximum possible spillage amount.

This requirement is applicable to **stationary equipment** and does not apply if the construction of the **battery** is such that leakage of the electrolyte from the **battery** is unlikely, or if spillage of electrolyte does not adversely affect required insulation.

NOTE An example of a **battery** construction where leakage of the electrolyte is considered to be unlikely is the sealed **cell** valve-regulated type.

Compliance is checked by inspection.

M.10 Instructions to prevent reasonably foreseeable misuse

A **battery** incorporated in the equipment and a **battery** together with its associated components (including **cells** and electric power generators) shall be so constructed that an electric shock or fire **safeguard** failure (for example, flammable chemical leakage causing fire or insulation damage) is unlikely, taking all reasonably foreseeable conditions into account. If applicable, this shall include extreme conditions as specified by the manufacturer, such as:

- high or low extreme temperatures that a **battery** can be subjected to during use, storage or transportation; and
- low air pressure at high altitude.

Where providing safety devices or design in a **battery** or equipment is not reasonably practical considering the functional nature of the **battery** or equipment containing a **battery**, **instructional safeguards** in accordance with Clause F.5 shall be provided to protect the **battery** from extreme conditions or user's abuse. Examples that shall be considered include:

- replacement of a **battery** with an incorrect type that can defeat a **safeguard** (for example, in the case of some lithium **battery** types);
- disposal of a **battery** into fire or a hot oven, or mechanically crushing or cutting of a **battery**, that can result in an **explosion**;
- leaving a **battery** in an extremely high temperature surrounding environment that can result in an **explosion** or the leakage of flammable liquid or gas;
- a **battery** subjected to extremely low air pressure that may result in an **explosion** or the leakage of flammable liquid or gas.

*Compliance is checked by inspection, by evaluation of available data provided by the manufacturer, and, if required, by **abnormal operating condition** tests according to B.3.6 considering all possible installation, transportation and use conditions.*

Annex N (normative)

Electrochemical potentials (V)

Magnesium, magnesium alloys	Zinc, zinc alloys	80 tin/20 zinc on steel, zinc on iron or steel I	Aluminium	Cadmium on steel	Aluminium/magnesium alloy	Mild steel	Duralumin	Lead	Chromium on steel, soft solder	Cr on Ni on steel, tin on steel, 12 % Cr stainless steel	High chromium stainless steel	Copper, copper alloys	Silver solder, austenitic stainless steel	Nickel on steel	Silver	Rhodium on silver on copper, silver/gold alloy	Carbon	Gold, platinum	
0	0,5	0,55	0,7	0,8	0,85	0,9	1,0	1,05	1,1	1,15	1,25	1,35	1,4	1,45	1,6	1,65	1,7	1,75	Magnesium, magnesium alloys
	0	0,05	0,2	0,3	0,35	0,4	0,5	0,55	0,6	0,65	0,75	0,85	0,9	0,95	1,1	1,15	1,2	1,25	Zinc, zinc alloys
		0	0,15	0,25	0,3	0,35	0,45	0,5	0,55	0,6	0,7	0,8	0,85	0,9	1,05	1,1	1,15	1,2	80 tin/20 zinc on steel, zinc on iron or steel
			0	0,1	0,15	0,2	0,3	0,35	0,4	0,45	0,55	0,65	0,7	0,75	0,9	0,95	1,0	1,05	Aluminium
				0	0,05	0,1	0,2	0,25	0,3	0,35	0,45	0,55	0,6	0,65	0,8	0,85	0,9	0,95	Cadmium on steel
					0	0,05	0,15	0,2	0,25	0,3	0,4	0,5	0,55	0,6	0,75	0,8	0,85	0,9	Aluminium/magnesium alloy
						0	0,1	0,15	0,2	0,25	0,35	0,45	0,5	0,55	0,7	0,75	0,8	0,85	Mild steel
							0	0,05	0,1	0,15	0,25	0,35	0,4	0,45	0,6	0,65	0,7	0,75	Duralumin
								0	0,05	0,1	0,2	0,3	0,35	0,4	0,55	0,6	0,66	0,7	Lead
									0	0,05	0,15	0,25	0,3	0,35	0,5	0,55	0,6	0,65	Chromium on steel, soft solder
										0	0,1	0,2	0,25	0,3	0,45	0,5	0,55	0,6	Cr on Ni on steel, tin on steel, 12 % Cr stainless steel
											0	0,1	0,15	0,2	0,35	0,4	0,45	0,5	High chromium stainless steel
												0	0,05	0,1	0,25	0,3	0,35	0,4	Copper, copper alloys
													0	0,05	0,2	0,25	0,3	0,35	Silver solder, austenitic stainless steel
														0	0,15	0,2	0,25	0,3	Nickel on steel
															0	0,05	0,1	0,15	Silver
																0	0,05	0,1	Rhodium on silver on copper, silver/gold alloy
																	0	0,05	Carbon
																		0	Gold, platinum

Corrosion due to electrochemical action between dissimilar metals that are in contact is minimized if the combined electrochemical potential is below about 0,6 V. In the table the combined electrochemical potentials are listed for a number of pairs of metals in common use; combinations above the dividing line should be avoided.

Annex O (normative)

Measurement of creepage distances and clearances

In the following Figures O.1 to O.20, the value of X is given in Table O.1. Where the distance shown is less than X , the depth of the gap or groove is disregarded when measuring a **creepage distance**.

If the required minimum **clearance** is more than 3 mm, the value of X is given in Table O.1.

If the required minimum **clearance** is less than 3 mm, the value of X is the smaller of:

- the relevant value in Table O.1; or
- one third of the required minimum **clearance**.

Table O.1 – Value of X

Pollution degree (see 5.4.1.5)	X mm
1	0,25
2	1,00
3	1,50

NOTE Throughout this annex, the following convention is used:



 ■ clearance
 ■■ creepage distance path

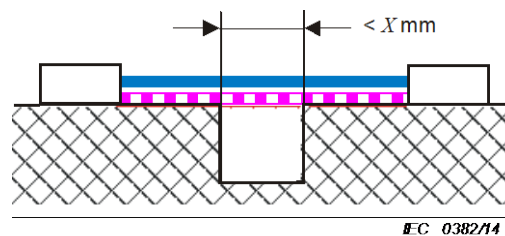

Condition: Path under consideration includes a parallel or converging-sided groove of any depth with width less than X mm. Rule: **Creepage distance** and **clearance** are measured directly across the groove.

Figure O.1 – Narrow groove

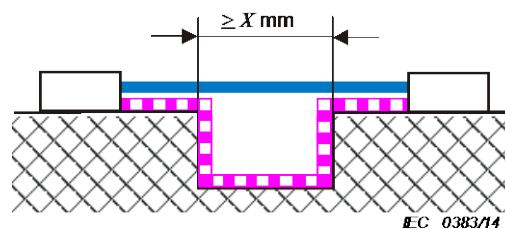

Condition: Path under consideration includes a parallel-sided groove of any depth, and equal to or more than X mm wide. Rule: **Clearance** is the "line of sight" distance. **Creepage distance** path follows the contour of the groove.

Figure O.2 – Wide groove

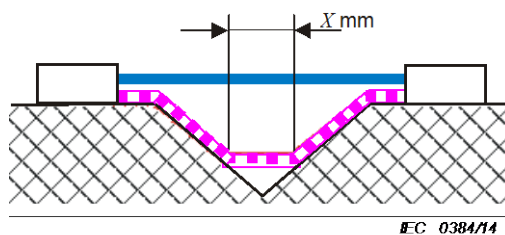

Condition: Path under consideration includes a V-shaped groove with an internal angle of less than 80° and a width greater than X mm.

Rule: **Clearance** is the "line of sight" distance. **Creepage distance** path follows the contour of the groove but "short-circuits" the bottom of the groove by X mm link.

Figure O.3 – V-shaped groove

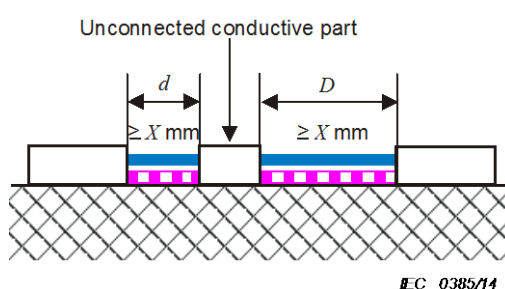

Condition: Insulation distance with intervening, unconnected conductive part.

Rule: **Clearance** is the distance $d + D$, **creepage distance** is also $d + D$. Where the value of d or D is smaller than X mm it shall be considered as zero.

Figure O.4 – Intervening unconnected conductive part

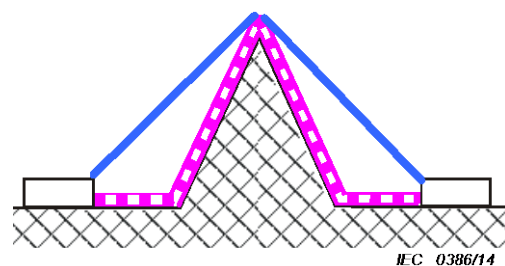

Condition: Path under consideration includes a rib.

Rule: **Clearance** is the shortest direct air path over the top of the rib. **Creepage distance** path follows the contour of the rib.

Figure O.5 – Rib

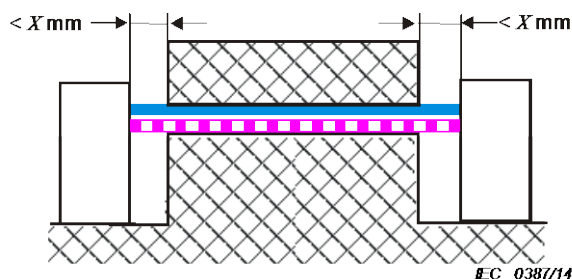

Condition: Path under consideration includes an uncemented joint with grooves less than X mm wide on either side.

Rule: **Clearance** and **creepage distance** path is the "line of sight" distance shown.

Figure O.6 – Uncemented joint with narrow groove

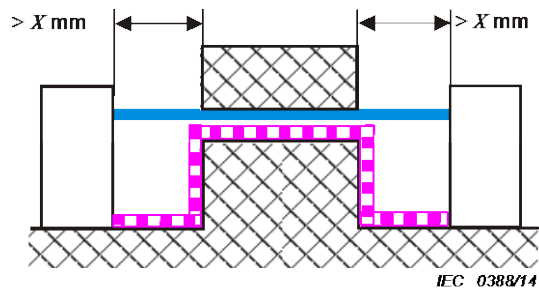

Condition: Path under consideration includes an uncemented joint with a groove equal to or more than X mm wide each side.

Rule: **Clearance** is the "line of sight" distance. **Creepage distance** path follows the contour of the groove.

Figure O.7 – Uncemented joint with wide groove

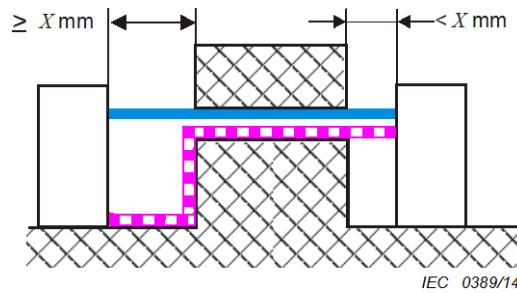

Condition: Path under consideration includes an uncemented joint with grooves on one side less than X mm wide, and a groove on the other equal to or more than X mm wide.

Rule: **Clearance** and **creepage distance** path are as shown.

Figure O.8 – Uncemented joint with narrow and wide grooves

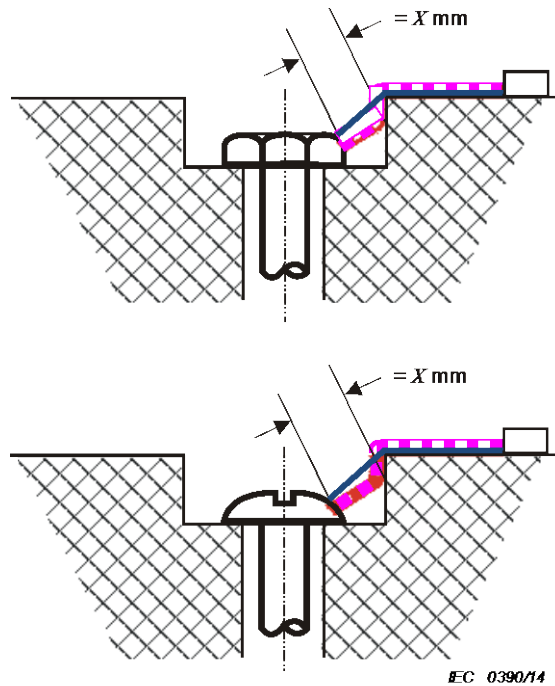

Gap between head of screw and wall of recess too narrow to be taken into account.

Where the gap between the head of the screw and the wall of recess is smaller than X mm, the measurement of **creepage distance** is made from the screw to the wall at the place where the distance is equal to X mm.

Figure O.9 – Narrow recess

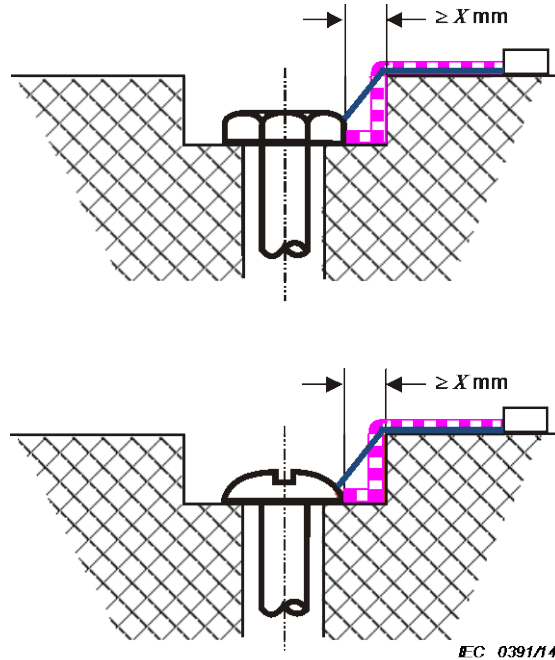

Gap between head of screw and wall of recess wide enough to be taken into account.

Figure O.10 – Wide recess

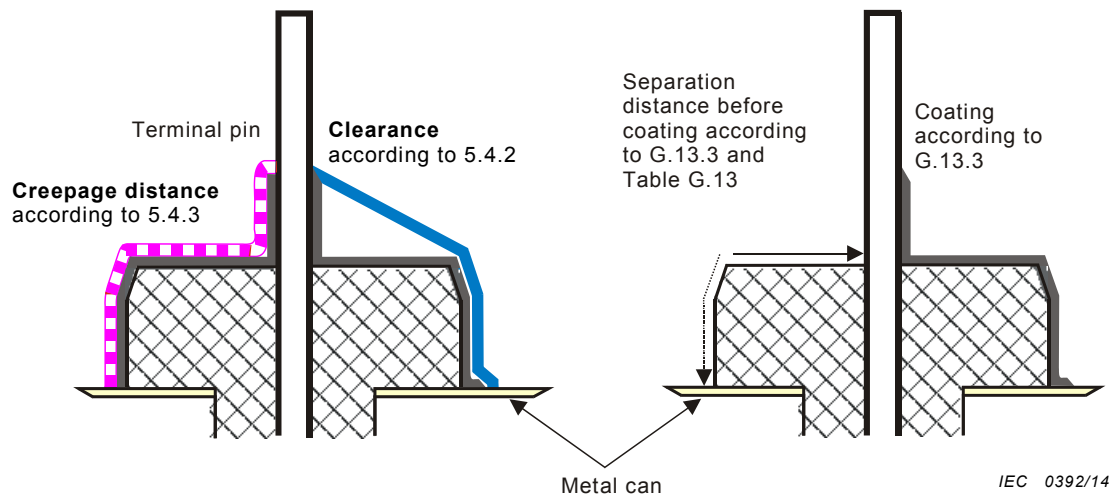
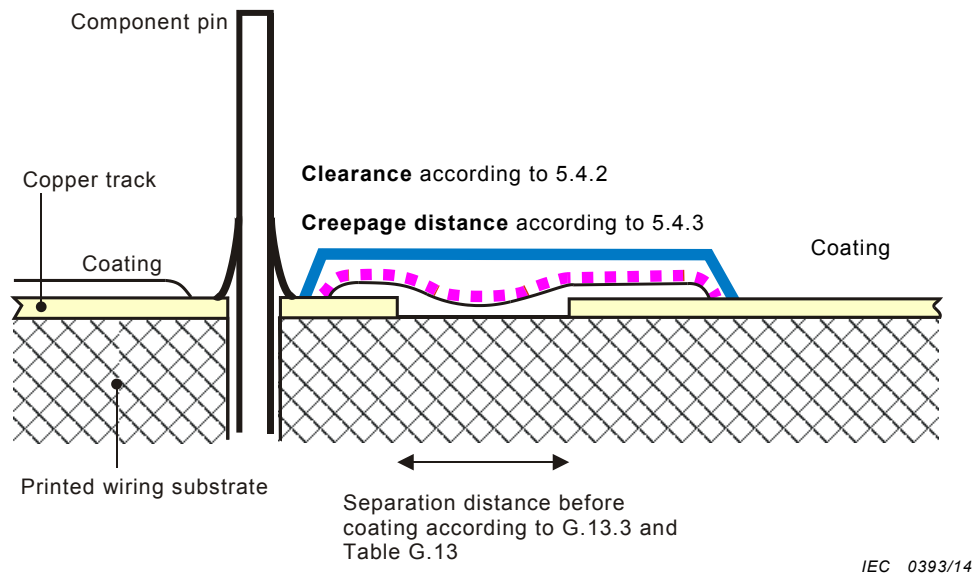
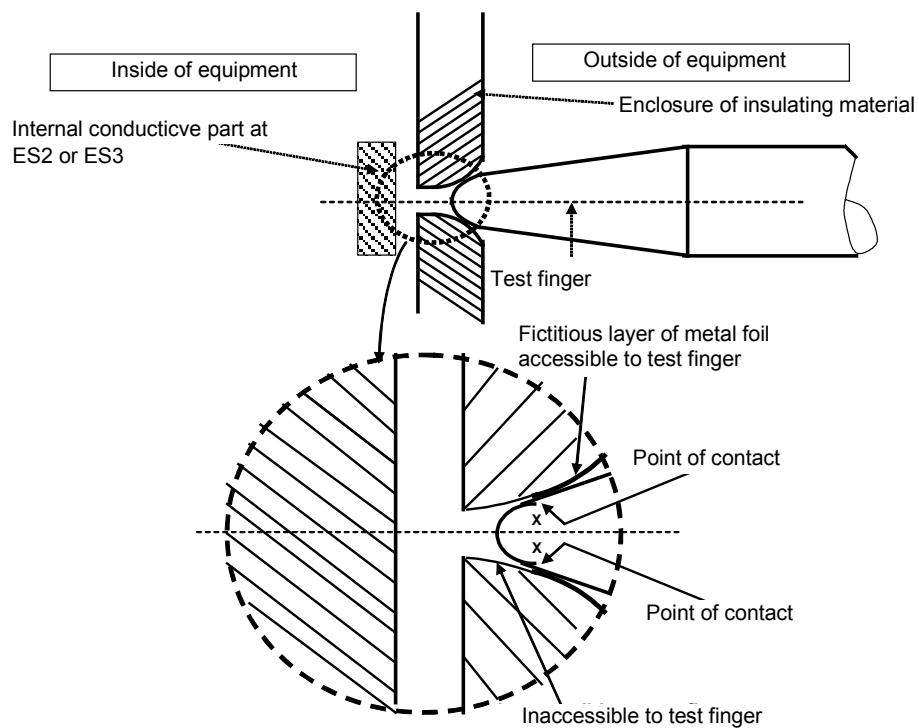

Figure O.11– Coating around terminals



IEC 0393/14

Figure O.12 – Coating over printed wiring



Point X is used for measurements of clearances and creepage distances from the outer surface of an enclosure of insulating material to and internal conductive part at ES2 or ES3

IEC 0394/14

Figure O.13 – Example of measurements in an enclosure of insulating material

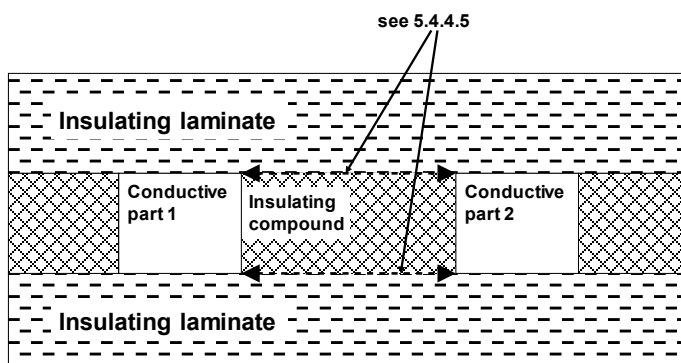

IEC 0395/14

Figure O.14 – Cemented joints in multi-layer printed boards

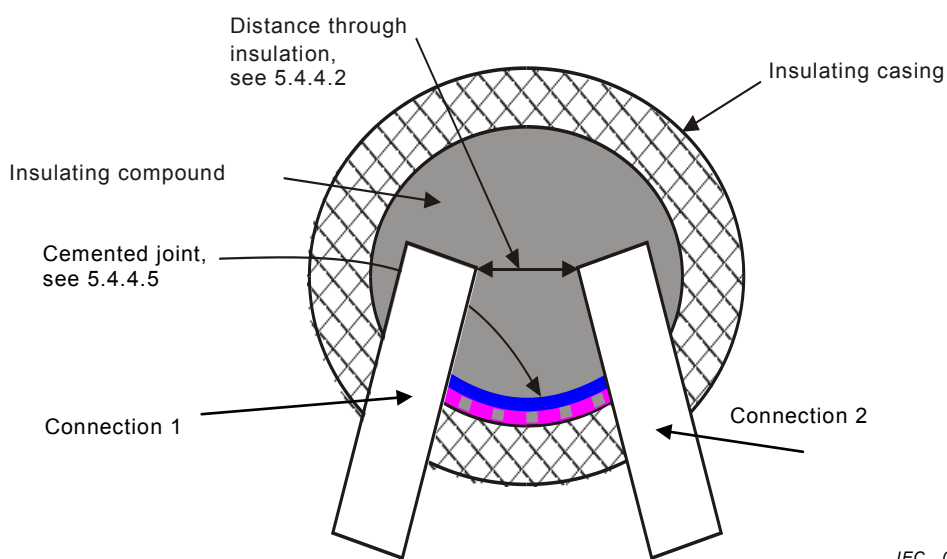

IEC 0396/14

Figure O.15 – Device filled with insulating compound

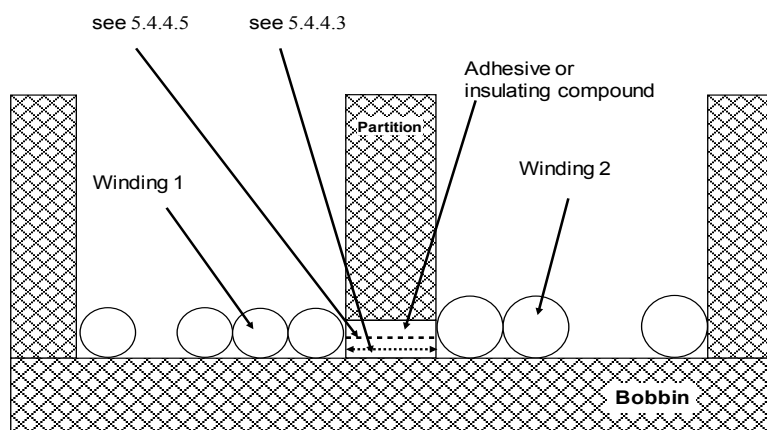

IEC 0397/14

Figure O.16 – Partitioned bobbin

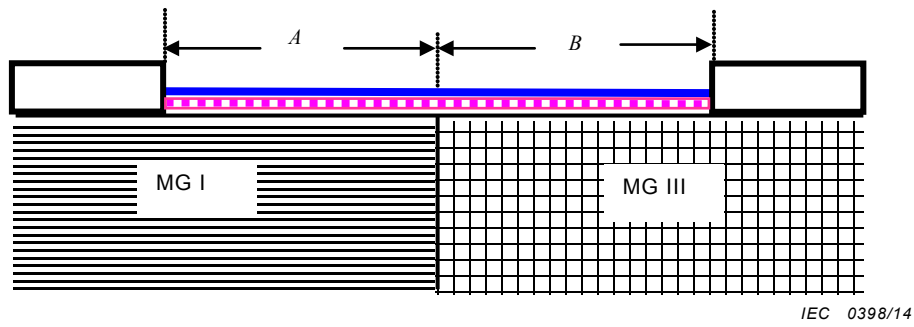

Condition: Path under consideration is along two materials having different CTI values.

Rule: **Creepage distance** is calculated as follows:

$$\frac{A}{\text{Required creepage for MG I}} + \frac{B}{\text{Required creepage for MG III}} \geq 1$$

Figure O.17 – Materials with different CTI values

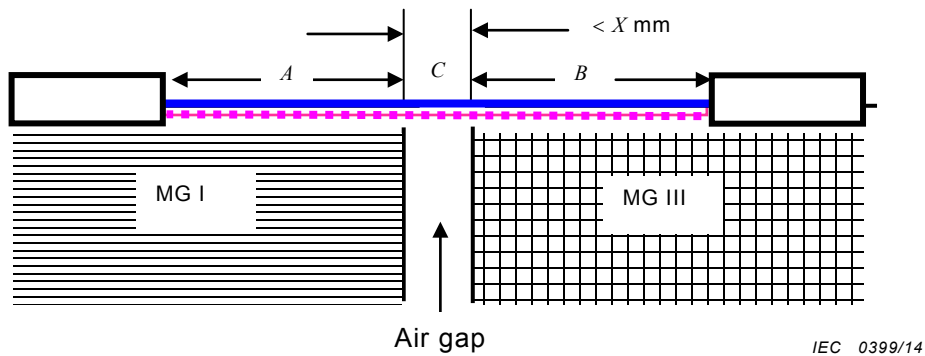

Condition: Path under consideration includes a parallel or converging-sided air gap having a width of less than X mm and two different materials on each side.

Rule: **Creepage distance** is calculated as follows:

$$\frac{A}{\text{Required creepage for MG I}} + \frac{B + C}{\text{Required creepage for MG III}} \geq 1$$

Figure O.18 – Materials with different CTI values having an air gap of less than X mm

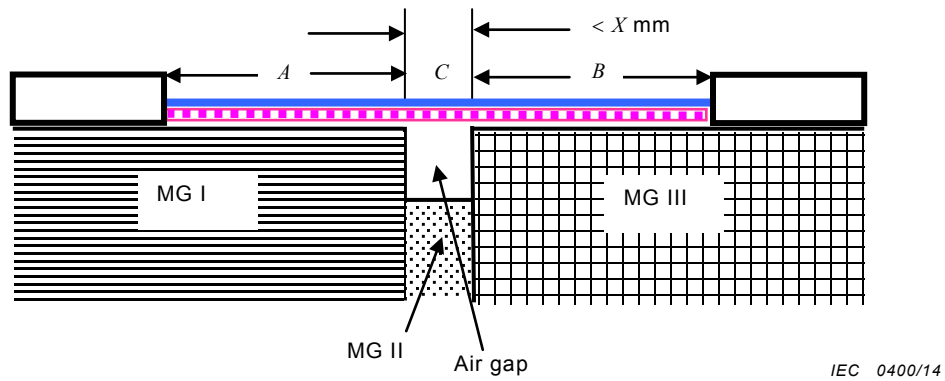

Condition: Path under consideration includes a parallel or converging-sided groove having a width of less than X mm and two different materials on each side and a different material below the groove.

Rule: **Creepage distance** is calculated as follows:

$$\frac{A}{\text{Required creepage for MG I}} + \frac{B + C}{\text{Required creepage for MG III}} \geq 1$$

Figure O.19 – Materials with different CTI values having an air groove of less than X mm

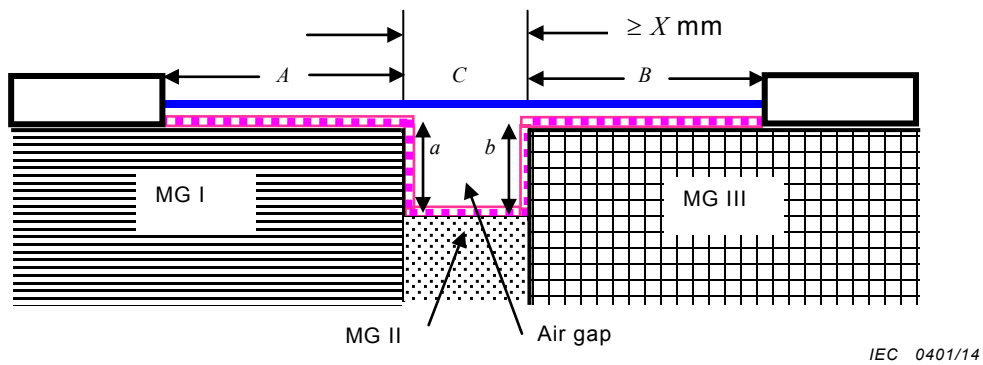

Condition: Path under consideration includes a parallel or converging-sided groove having a width greater than or equal to X mm and two different materials on each side and a different material below the groove.

Rule: **Creepage distance** is calculated as follows:

$$\frac{A + a}{\text{Required creepage for MG I}} + \frac{C}{\text{Required creepage for MG II}} + \frac{B + b}{\text{Required creepage for MG III}} \geq 1$$

Figure O.20 – Materials with different CTI values having an air groove not smaller than X mm

Annex P (normative)

Safeguards against conductive objects

P.1 General

This annex specifies **safeguards** to reduce the likelihood of fire, electric shock and adverse chemical reaction due to the entry of objects through top or side openings in the equipment, or due to spillage of internal liquids, or the failure of metalized coatings and adhesives securing conductive parts inside the equipment.

The **basic safeguard** against entry of a foreign object is that persons are not expected to insert a foreign object into the equipment. The **safeguards** specified in this annex are **supplementary safeguards**.

This annex does not apply to openings that are parts of connectors.

For equipment intended, according to the manufacturer's instructions, to be used in more than one orientation, the **safeguards** shall be effective for each such orientation.

For **transportable equipment**, the **safeguards** shall be effective for all orientations.

NOTE The examples of Figure P.1, Figure P.2 and Figure P.3 are not intended to be used as engineering drawings but are only shown to illustrate the intent of these requirements.

P.2 Safeguards against entry or consequences of entry of a foreign object

P.2.1 General

Equipment shall comply with the requirements of P.2.2 or with the requirements of P.2.3.

P.2.2 Safeguards against entry of a foreign object

Openings in the top and sides of an **accessible enclosure** shall be so located or constructed to reduce the likelihood that a foreign object will enter the openings.

Equipment openings shall comply with the requirements specified below when the doors, panels, and covers, etc., are closed or in place. These requirements do not apply to openings located behind doors, panels, covers, etc., even if they can be opened or removed by an **ordinary person**.

The following constructions are considered to comply:

- openings that do not exceed 5 mm in any dimension;
- openings that do not exceed 1 mm in width regardless of length;
- openings that meet the requirements of IP3X or IP4X;
- top openings in which vertical entry is prevented (see Figure P.1 for examples);
- side openings provided with louvres that are shaped to deflect outwards an external vertically falling object (see Figure P.2 for examples);
- side openings without louvres where the **enclosure** thickness at the opening is not less than the vertical dimension of the opening.

Compliance is checked by inspection or measurement.

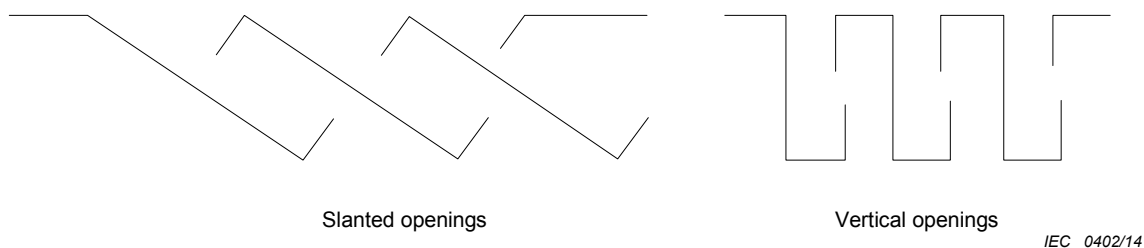

Figure P.1 – Examples of cross-sections of designs of top openings which prevent vertical entry

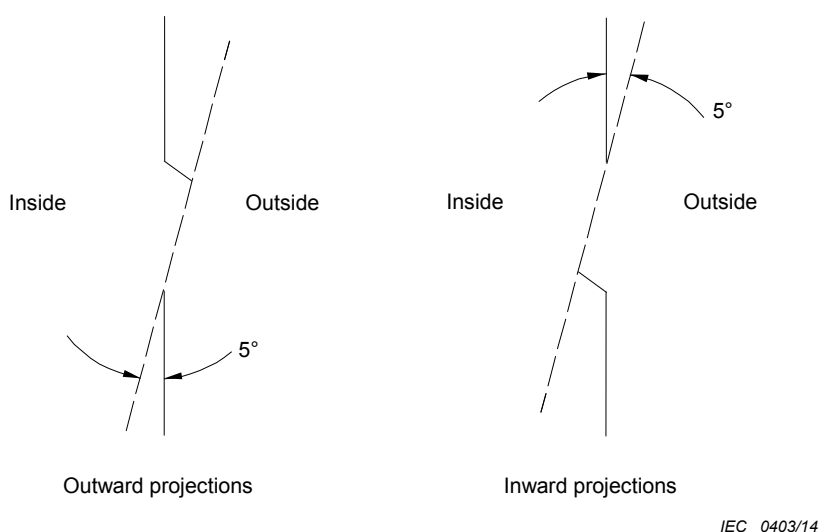

Figure P.2 – Examples of cross-sections of designs of side opening louvres which prevent vertical entry

P.2.3 Safeguards against the consequences of entry of a foreign object

P.2.3.1 Safeguard requirements

The entry of a foreign object shall not defeat an **equipment supplementary safeguard** or an **equipment reinforced safeguard**. Furthermore, the object shall not create a **PIS**.

Safeguards against the consequences of entry of foreign objects include the following:

- an internal barrier that prevents a foreign object from defeating an **equipment safeguard** or creating a **PIS**;
- within the projected volume as depicted in Figure P.3 there are
 - no bare conductive parts of a **safeguard**; or
 - no **PIS**; or
 - no bare conductive parts of ES3 or PS3 circuits; or
 - only conductive parts covered with conformal or other similar coatings.

NOTE 1 Conductive parts covered with conformal or other similar coatings are not considered to be bare conductive parts. A conformal coating is a dielectric material deposited on a printed circuit board and components in order to protect them against moisture, dust, corrosion and other environmental stresses.

- within the projected volume as depicted in Figure P.3, bare conductive parts at ES3 or PS3 subjected to the tests of P.2.3.2.

Other constructions shall be subject to the test of P.2.3.2.

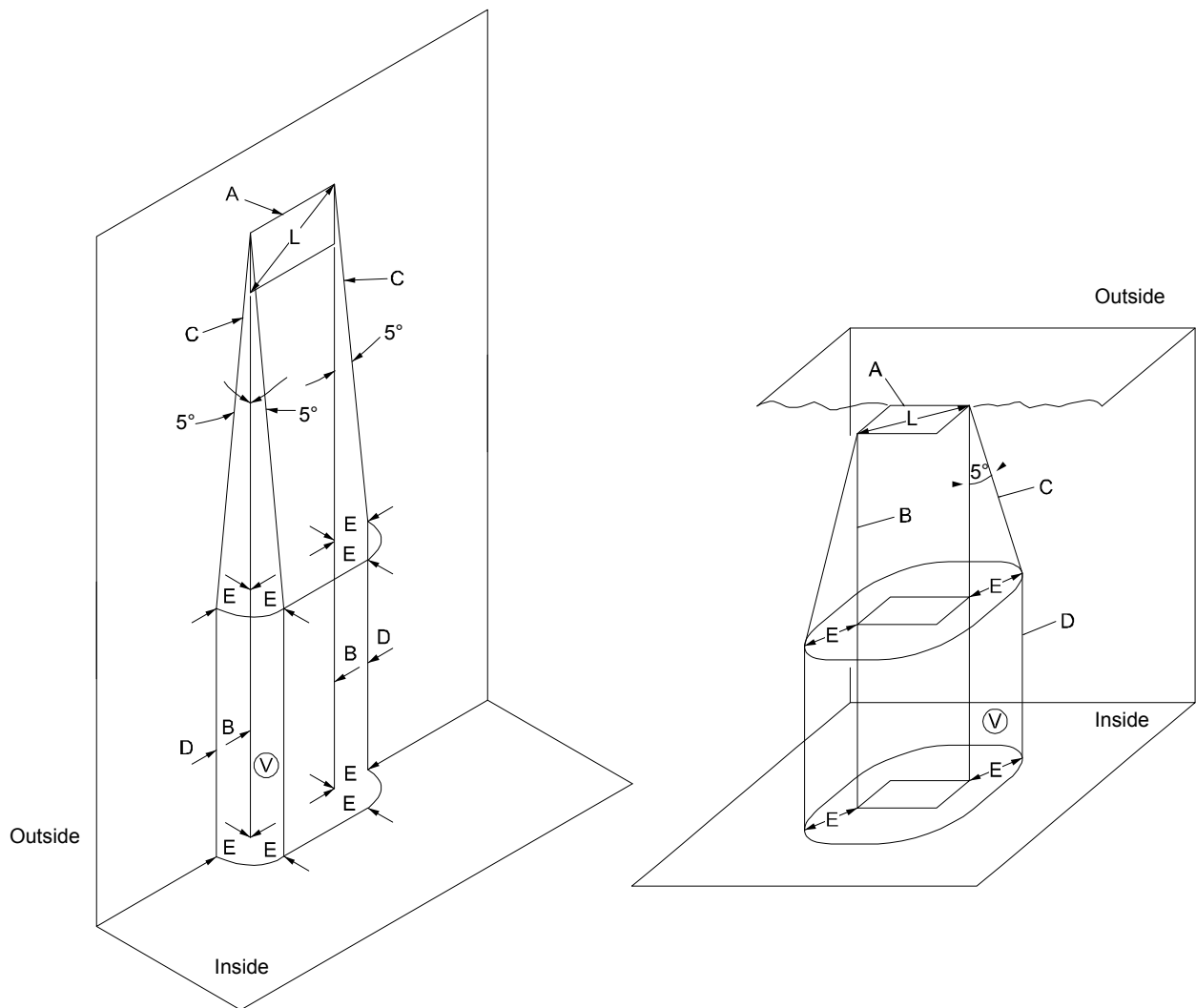

IEC 0404/14

Key

- A **enclosure** opening
- B vertical projection of the outer edges of the opening
- C inclined lines that project at a 5° angle from the edges of the opening to points located E distance from B
- D line that is projected straight downward in the same plane as the **enclosure** side wall
- E projection of the outer edge of the opening (B) and the inclined line (C) (not to be greater than L)
- L maximum dimension of the **enclosure** opening
- V projected (keep-out) volume for **supplementary** or **reinforced safeguards**

Figure P.3 – Internal volume locus for foreign object entry

For **transportable equipment**, if the design does not prevent the entry of a foreign object, the object is considered to move to any place within the equipment. The ES3 and PS3 keep-out volume in Figure P.3 is not applicable to **transportable equipment**.

For **transportable equipment** with metallized plastic parts and the like, if the design does not prevent the entry of a foreign object, the distance between the metallized parts and all bare conductive parts of ES3 or PS3 shall be at least 13 mm. Alternatively, the metallized parts and the bare conductive parts shall be tested by shorting.

NOTE 2 Examples of metallized barriers or metallized **enclosures** include those made of conductive composite materials or materials that are electroplated, vacuum-deposited, foil lined or painted with metallic paint.

Compliance is checked by inspection, measurement, and where necessary by the test of P.2.3.2.

P.2.3.2 Consequence of entry test

An attempt shall be made to short all bare conductive parts of ES3 or PS3 within volume V, Figure P.3, along a direct straight path to all other bare conductive parts and to all metallized parts within a 13 mm radius. The attempt of shorting is made by means of a straight metal object, 1 mm in diameter and having any length up to 13 mm, applied without appreciable force.

For **transportable equipment**, the attempt of shorting shall be at all places where the foreign object could lodge.

During and after the tests, all **supplementary safeguards** and **reinforced safeguards** shall be effective, and no part shall become a **PIS**.

P.3 Safeguards against spillage of internal liquids

P.3.1 General

The requirements specified below apply to equipment with internal liquids where that liquid may defeat any **equipment safeguard**.

These requirements do not apply to:

- liquids that are non-conductive, non-flammable, non-toxic, and non-corrosive, and are not in a pressurized container;
- electrolytic capacitors;
- liquids with viscosity of 1 Pa s or more;
- **batteries** (see Annex M).

NOTE Viscosity of 1 Pa s is approximately equivalent to 60 weight motor oil.

P.3.2 Determination of spillage consequences

If the equipment is not **transportable equipment**, the equipment shall be energized, and the liquid shall be allowed to leak from piping connectors and similar joints in the liquid system.

If the equipment is **transportable equipment**, then, following introduction of the leak, the equipment shall be moved to all possible positions and then energized.

P.3.3 Spillage safeguards

If the spillage may result in a **single fault condition** not covered by Clause B.4, then:

- the vessel serving as a **basic safeguard** shall allow no spillage under **normal operating conditions**, and the **supplementary safeguard** (for example, a barrier or drip pan or supplementary containment vessel, etc.) shall effectively limit the spread of the spillage; or
- the liquid shall be contained in a vessel comprising a **reinforced safeguard**; or
- the containment vessel **safeguard** shall comprise a **double safeguard** or a **reinforced safeguard**.

If the liquid is conductive, flammable, toxic, or corrosive, then:

- the liquid shall be contained in a **double safeguard** or a **reinforced safeguard**; or

- following the spillage:
 - a toxic liquid shall not be **accessible** to **ordinary persons** or **instructed persons**, and
 - a conductive liquid shall not bridge a **basic insulation**, a **supplementary insulation** or a **reinforced insulation**, and
 - a flammable liquid (or its vapour) shall not contact any **PIS** or parts at a temperature that may ignite the liquid, and
 - a corrosive liquid shall not contact any connection of a **protective conductor**.

A vessel that meets the relevant test requirements of Clause G.15 is considered to comprise a **reinforced safeguard**.

NOTE The following liquids are generally considered non-flammable:

- Oil or equivalent liquids used for lubrication or in a hydraulic system having a flash point of 149 °C or higher; or
- Replenishable liquids such as printing inks having a flash point of 60 °C or higher.

P.3.4 Compliance criteria

Compliance is checked by inspection or available data, and where necessary, by the relevant tests.

*During and after the tests, all **supplementary safeguards** and **reinforced safeguards** shall be effective, and no part shall become a **PIS**.*

P.4 Metallized coatings and adhesives securing parts

P.4.1 General

The metalized coating and adhesive shall have adequate bonding properties throughout the life of the equipment.

Compliance is checked by examination of the construction and of the available data. If such data is not available, compliance is checked by the tests of P.4.2.

P.5 For metalized coatings, clearances and creepage distances for pollution degree 3 shall be maintained instead of the tests of P.4.2.

P.5.1 Tests

A sample of the equipment or a subassembly of the equipment containing parts having metalized coating and the parts joined by adhesive is evaluated with the sample placed with the part secured by adhesive on the underside.

Condition the sample in an oven at a temperature T_C for the specified duration (eight weeks, three weeks or one week) as follows:

$$T_C = T_R + (T_A + 10 - T_S)$$

In case the value for $T_A + 10 - T_S$ is negative, the value will be replaced by zero.

where

T_C is the conditioning temperature;

T_R is the rated conditioning temperature value of (82 ± 2) °C for eight weeks; (90 ± 2) °C for three weeks; or (100 ± 2) °C (for one week) as applicable;

T_A is the temperature of the coating or the part under **normal operating conditions** (see B.2.6.1);

$T_S = 82$.

NOTE 1 For example for eight week conditioning, if the actual temperature is 70 °C, then the $T_A + 10 - T_S = 70 + 10 - 82 = -2$, then this -2 is ignored. The minimum conditioning temperature remains 82 °C. Also, for three week conditioning, if the actual temperature is 70 °C, then the $T_A + 10 - T_S = 70 + 10 - 82 = -2$, then this -2 is ignored. The minimum conditioning temperature remains 90 °C. Also, for one week conditioning, if the actual temperature is 70 °C, then the $T_A + 10 - T_S = 70 + 10 - 82 = -2$, then this -2 is ignored. The minimum conditioning temperature remains 100 °C.

NOTE 2 For example for eight week conditioning, if the actual temperature is 75 °C, then the $T_A + 10 - T_S = 75 + 10 - 82 = +3$, the minimum conditioning temperature becomes $82 + 3 = 85$ °C. Also, for three week conditioning, if the actual temperature is 75 °C, then the $T_A + 10 - T_S = 75 + 10 - 82 = +3$, then the minimum conditioning temperature remains $90 + 3 = 93$ °C. Also, for one week conditioning, if the actual temperature is 75 °C, then the $T_A + 10 - T_S = 75 + 10 - 82 = +3$, then the minimum conditioning temperature remains $100 + 3 = 103$ °C.

NOTE 3 The table below gives the summary of the results in NOTE 1 and NOTE 2:

T_A	T_R	T_S	$T_A + 10 - T_S$	$T_C = T_R + T_A + 10 - T_S$
70	82 (8 weeks)	82	$70+10-82= -2$	$82 + 0 = 82$
70	90 (3 weeks)	82	$70+10-82= -2$	$90 + 0 = 90$
70	100 (1 week)	82	$70+10-82= -2$	$100 + 0 = 100$
75	82 (8 weeks)	82	$75+10-82= +3$	$82 + 3 = 85$
75	90 (3 weeks)	82	$75+10-82= +3$	$90 + 3 = 93$
75	100 (1 week)	82	$75+10-82= +3$	$100 + 3 = 103$

Upon completion of the temperature conditioning, subject the sample to the following:

- remove the sample from oven and leave it at any convenient temperature between 20 °C and 30 °C for a minimum of 1 h;
- place the sample in a freezer at -40 °C \pm 2 °C for a minimum of 4 h;
- remove and allow the sample to come to any convenient temperature between 20 °C and 30 °C for a minimum of 8 h;
- place the sample in a cabinet at 91 % to 95 % relative humidity for 72 h at any convenient temperature between 20 °C and 30 °C;
- remove the sample and leave it at any convenient temperature between 20 °C and 30 °C for a minimum of 1 h;
- place the sample in an oven at the temperature used for the temperature conditioning (T_C) for a minimum of 4 h;
- remove the sample and allow it to reach any convenient temperature between 20 °C; and 30 °C for a minimum of 8 h.

The sample is then immediately subjected to the tests of Annex T according to 4.4.4.

With the concurrence of the manufacturer, the above time durations may be extended.

After the above tests:

- *a metalized coating or a part secured by adhesive shall not fall off or partly dislodge;*
- *a metalized coating shall be subjected to the abrasion resistance test of G.13.6.2. After the abrasion resistance test, the coating shall have not loosened and no particles shall become loose from the coating;*
- **enclosure parts serving as *safeguards* shall comply with all the applicable requirements for *enclosures*.**

Annex Q (normative)

Circuits intended for interconnection with building wiring

Q.1 Limited power source

Q.1.1 Requirements

A limited power source shall comply with one of the following:

- a) the output is inherently limited in compliance with Table Q.1; or
- b) linear or non-linear impedance limits the output in compliance with Table Q.1. If a PTC device is used, it shall:
 - 1) pass the tests specified in Clauses 15, 17, J.15 and J.17 of IEC 60730-1:2010; or
 - 2) meet the requirements of IEC 60730-1 for a device providing Type 2.AL action;
 - 3) a regulating network limits the output in compliance with Table Q.1, both with and without a simulated single fault (see Clause B.4), in the regulating network (open circuit or short-circuit); or
- c) an overcurrent protective device is used and the output is limited in compliance with Table Q.2; or
- d) an IC current limiter complying with Clause G.9 that limits the output current in accordance with Table Q.1.

Where an overcurrent protective device is used, it shall be a fuse or a non-adjustable, non-autoreset, electromechanical device.

Q.1.2 Test method and compliance criteria

*Compliance is checked by inspection and measurement and, where appropriate, by examination of the manufacturer's data for **batteries**. Batteries shall be fully charged when conducting the measurements for U_{oc} and I_{sc} according to Table Q.1 and Table Q.2. The maximum power shall be considered, such as from a **battery** and from a **mains** circuit.*

*The non-capacitive load referenced in footnotes b) and c) of Table Q.1 and Table Q.2 is adjusted to develop maximum current and power transfer respectively. **Single fault conditions** are applied in a regulating network according to Clause Q.1.1, item b) 3) under these maximum current and power conditions.*

Table Q.1 – Limits for inherently limited power sources

Output voltage ^a U_{oc}		Output current ^{b d} I_{sc}	Apparent power ^{c d} S
V a.c.	V d.c.	A	VA
$U_{oc} \leq 30$	$U_{oc} \leq 30$	$\leq 8,0$	≤ 100
–	$30 < U_{oc} \leq 60$	$\leq 150/U_{oc}$	≤ 100

^a U_{oc} : Output voltage measured in accordance with B.2.3 with all load circuits disconnected. Voltages are for substantially sinusoidal a.c. and ripple free d.c. For non-sinusoidal a.c. and d.c. with ripple greater than 10 % of the peak, the peak voltage shall not exceed 42,4 V.

^b I_{sc} : Maximum output current with any non-capacitive load, including a short-circuit.

^c S (VA): Maximum output VA with any non-capacitive load.

^d Measurement of I_{sc} and S are made 5 s after application of the load if protection is by an electronic circuit and 60 s in case of a PTC device or in other cases.

**Table Q.2 – Limits for power sources not inherently limited
(overcurrent protective device required)**

Output voltage ^a U_{oc}		Output current ^{b d} I_{sc}	Apparent power ^{c d} S	Current rating of overcurrent protective device ^e
V a.c.	V d.c.	A	VA	A
≤20	≤20	≤1 000/ U_{oc}	≤250	≤5,0
20 < U_{oc} ≤ 30	20 < U_{oc} ≤ 30			≤100/ U_{oc}
–	30 < U_{oc} ≤ 60			≤100/ U_{oc}

^a U_{oc} : Output voltage measured in accordance with B.2.3 with all load circuits disconnected. Voltages are for substantially sinusoidal a.c. and ripple free d.c. For non-sinusoidal a.c. and for d.c. with ripple greater than 10 % of the peak, the peak voltage shall not exceed 42,4 V.

^b I_{sc} : Maximum output current with any non-capacitive load, including a short-circuit, measured 60 s after application of the load.

^c S (VA): Maximum output VA with any non-capacitive load measured 60 s after application of the load.

^d Current limiting impedances in the equipment remain in the circuit during measurement, but overcurrent protective devices are bypassed.

The reason for making measurements with overcurrent protective devices bypassed is to determine the amount of energy that is available to cause possible overheating during the operating time of the overcurrent protective devices.

^e The current ratings of overcurrent protective devices are based on fuses and circuit breakers that break the circuit within 120 s with a current equal to 210 % of the current rating specified in the table.

Q.2 Test for external circuits – paired conductor cable

Equipment supplying power to an **external circuit** paired conductor cable intended to be connected to the building wire shall be checked as follows.

If current limiting is due to the inherent impedance of the power source, the output current into any resistive load, including a short-circuit, is measured. The current limit shall not be exceeded after 60 s of test.

If current limiting is provided by an overcurrent protective device having a specified time/current characteristic:

- the time/current characteristic shall show that a current equal to 110 % of the current limit will be interrupted within 60 min; and
- the output current into any resistive load, including a short-circuit, with the overcurrent protective device bypassed, measured after 60 s of test, shall not exceed $1\,000/U$ where U is the output voltage measured in accordance with B.2.3 with all load circuits disconnected.

If current limiting is provided by an overcurrent protective device that does not have a specified time/current characteristic:

- the output current into any resistive load, including a short-circuit, shall not exceed the current limit after 60 s of test; and
- the output current into any resistive load, including a short-circuit, with the overcurrent protective device bypassed, measured after 60 s of test, shall not exceed $1\,000/U$, where U is the output voltage measured in accordance with B.2.3 with all load circuits disconnected.

Annex R (normative)

Limited short-circuit test

R.1 General

This annex documents the test procedure and compliance criteria for the limited short-circuit test. This test demonstrates that a **protective bonding conductor**, used in circuits protected by a device having a rating not exceeding 25 A, is suitable for the fault current permitted by the overcurrent protective device, and in doing so, tests the integrity of a **supplementary safeguard**.

R.2 Test setup

*The source used to conduct the limited short-circuit test shall be short-circuited at its output terminals and the current measured to ensure that it can supply at least 1 500 A. This can be an a.c. wall socket, generator, power supply or **battery**.*

If the overcurrent protective device is provided in the equipment, then this is used for the test.

For a.c. sources where only one overcurrent protective device is provided in the equipment and the plug is non-polarised, the protective device in the building installation is used for the test and the internal overcurrent protective device is by-passed. The manufacturer shall specify the device used for the test in the equipment safety instructions.

Where there is no protective device present in the equipment, a suitable overcurrent protective device shall be chosen. This overcurrent protective device shall be such that it does not interrupt the fault current before half a cycle has passed. The overcurrent protective device in the building installation for a.c. sources, or that specified to be provided externally to the equipment for d.c. sources, is used for the test. The manufacturer shall then specify the device used to conduct the test in the equipment safety instructions.

R.3 Test method

*The source shall be applied to the EUT via the **mains** cord supplied or specified by the equipment manufacturer. Where there is no **mains** cord supplied or specified, a 1 m length of 2,5 mm² or 12 AWG shall be used. For d.c. sources, the cable shall be sized for the maximum rated input current of the equipment.*

To conduct this test a short-circuit in the equipment to the earth connection of the equipment shall be introduced. The point at which this is done is depending on the equipment. After consideration of the equipment construction and circuit diagrams, the short-circuit shall be introduced between the phase conductor, at the point nearest to the input (the point of lowest impedance), and the protective bonding path under consideration. There may be more than one point at which this short-circuit may be applied to determine the worst case.

*The **protective bonding conductor** is connected to a source capable of supplying an a.c. or d.c. current, as appropriate to the EUT, of 1 500 A under short-circuit conditions, and using a source voltage equal to the **rated voltage** or any voltage within the **rated voltage range** of the equipment. In cases where the prospective short-circuit current seen by the equipment is known, then the source used for test shall be able to supply that current under short-circuit conditions. The manufacturer shall state the prospective short-circuit current that has been used in the evaluation in the safety instructions. The overcurrent protective device protecting the circuit under consideration (in accordance with Clause R.2) is kept in series with the*

protective bonding conductor. *The power supply cord, if provided or specified, shall remain connected when conducting the test.*

*The limited short-circuit test for **protective bonding conductors** in a potted or conformally coated assembly is conducted on a potted or coated sample.*

The test is conducted two more times (for a total of three times, on a different sample unless the manufacturer agrees to conduct the test on the same sample). The test is continued until the overcurrent protective device operates.

R.4 Compliance criteria

At the conclusion of the test, compliance is checked by inspection as follows.

There shall be

- no damage to the **protective bonding conductor**,*
- no damage to any **basic insulation, supplementary insulation, or reinforced insulation**,*
- no reduction of **clearances, creepage distances and distances through insulation**,*
- no delamination of the printed board.*

Annex S (normative)

Tests for resistance to heat and fire

NOTE Toxic fumes are given off during the tests. The tests are usually carried out either under a ventilated hood or in a well-ventilated room, but free from draughts that could invalidate the tests.

S.1 Flammability test for fire enclosure and fire barrier materials of equipment where the steady-state power does not exceed 4 000 W

Fire enclosure and fire barrier materials are tested according to IEC 60695-11-5.

The following additional requirements apply to the specified clauses of IEC 60695-11-5:2004.

Clause 6 of IEC 60695-11-5:2004 – Test specimen

For fire enclosures and fire barriers, each test specimen consists of either a complete fire enclosure or fire barrier or a section of the fire enclosure or fire barrier representing the thinnest significant wall thickness and including any ventilation opening.

Clause 7 of IEC 60695-11-5:2004 – Severities

The values of duration of application of the test flame are as follows:

- the test flame is applied for 10 s;*
- if flaming does not exceed 30 s, the test flame is immediately reapplied for 1 min at the same point;*
- if again flaming does not exceed 30 s, the test flame is immediately reapplied for 2 min at the same point.*

Clause 8 of IEC 60695-11-5:2004 – Conditioning of test specimen

Prior to being tested, the samples are conditioned in a circulating air oven for a period of 7 days (168 h), at a temperature 10 K higher than the maximum temperature of the part measured during the test of 5.4.1.4 or 70 °C, whichever is the higher, and then cooled to room temperature.

For printed boards, a preconditioning of 24 h at a temperature of 125 °C ± 2 °C in an air circulating oven and a subsequent cooling period of 4 h at room temperature in a desiccator over anhydrous calcium chloride is to be applied.

Subclause 9.2 of IEC 60695-11-5:2004 – Application of needle flame

The test flame is applied to an inside surface of the test specimen at a point judged to be likely to become ignited because of its proximity to a source of ignition.

If a vertical part is involved, the flame is applied at an angle of approximately 45° from the vertical.

If ventilation openings are involved, the flame is applied to an edge of an opening, otherwise to a solid surface. In all cases, the tip of the flame is to be in contact with the test specimen.

The test is repeated on the remaining two test specimens. If any part being tested is near a source of ignition at more than one point, each test specimen is tested with the flame applied to a different point that is near a source of ignition.

Clause 11 of IEC 60695-11-5:2004 – Evaluation of test results

The existing text is replaced by the following.

The test specimens shall comply with all of the following:

- after every application of the test flame, the test specimen shall not be consumed completely; and*
- after any application of the test flame, any self-sustaining flame shall extinguish within 30 s; and*
- no burning of the specified layer or **wrapping tissue** shall occur.*

S.2 Flammability test for fire enclosure and fire barrier integrity

*Compliance of **fire enclosure** and fire barrier integrity is checked according to IEC 60695-11-5.*

For the purpose of this standard, the following additional requirements apply to the stated clauses of IEC 60695-11-5:2004.

Clause 6 of IEC 60695-11-5:2004 – Test specimen

*For **fire enclosures** and fire barriers, each test specimen consists of either a complete **fire enclosure** and fire barrier or a section of the **fire enclosure** and fire barrier representing the thinnest significant wall thickness and including any ventilation opening.*

Clause 7 of IEC 60695-11-5:2004 – Severities

The value of duration of application of the test flame is as follows:

- the test flame is applied for 60 s.*

Clause 8 of IEC 60695-11-5:2004 – Conditioning of test specimen

Prior to being tested, the samples are conditioned in a circulating air oven for a period of 7 days (168 h), at a temperature 10 K higher than the maximum temperature of the part measured during the test of 5.4.1.4 or 70 °C, whichever is the higher, and then cooled to room temperature.

For printed boards, a preconditioning of 24 h at a temperature of 125 °C ± 2 °C in an air circulating oven and a subsequent cooling period of 4 h at room temperature in a desiccator over anhydrous calcium chloride is to be applied.

Subclause 9.2 of IEC 60695-11-5:2004 – Application of needle flame

The test flame is applied to an inside surface of the test specimen at a point judged to be likely to become ignited because of its proximity to a source of ignition.

If a vertical part is involved, the flame is applied at an angle of approximately 45° from the vertical.

If ventilation openings are involved, the flame is applied to an edge of an opening, otherwise to a solid surface. In all cases, the tip of the flame is to be in contact with the test specimen.

The test is repeated on the remaining two test specimens. If any part being tested is near a source of ignition at more than one point, each test specimen is tested with the flame applied to a different point that is near a source of ignition.

Clause 11 of IEC 60695-11-5:2004 – Evaluation of test results

The existing text is replaced by the following.

The test specimens shall comply with the following:

After application of the test flame, the test specimen shall not show any additional holes.

S.3 Flammability tests for the bottom of a fire enclosure

S.3.1 Mounting of samples

*A sample of the complete finished bottom of the **fire enclosure** is securely supported in a horizontal position. A **cheesecloth** is placed in one layer over a shallow, flat-bottomed pan approximately 50 mm below the sample, and is of sufficient size to cover completely the pattern of openings in the sample, but not large enough to catch any of the oil that runs over the edge of the sample or otherwise does not pass through the openings.*

*Use of a metal screen or a wired-glass **enclosure** surrounding the test area is recommended.*

S.3.2 Test method and compliance criteria

A small metal ladle (preferably no more than 65 mm in diameter), with a pouring lip and a long handle whose longitudinal axis remains horizontal during pouring, is partially filled with 10 ml of diesel fuel oil. The ladle containing the oil is heated and the oil ignited and allowed to burn for 1 min, at which time all of the hot flaming oil is poured at the rate of approximately 1 ml/s in a steady stream onto the centre of the pattern of openings, from a position approximately 100 mm above the openings.

NOTE "Diesel fuel oil" is regarded to be similar to a medium volatile distillate fuel oil having a mass per unit volume between 0,845 g/ml and 0,865 g/ml, a flash point between 43,5 °C and 93,5 °C and an average calorific value of 38 MJ/l

*The test is repeated twice at 5 min intervals, using clean **cheesecloth**.*

*During these tests the **cheesecloth** shall not ignite.*

S.4 Flammability classification of materials

Materials are classified according to the burning behaviour and their ability to extinguish, if ignited. Tests are made with the material in the thinnest significant thickness used.

The hierarchies of the **material flammability classes** are given in Table S.1, Table S.2 and Table S.3.

Table S.1 – Foamed materials

Material flammability class	ISO standard
HF-1 regarded better than HF-2	ISO 9772
HF-2 regarded better than HBF	ISO 9772
HBF	ISO 9772

Table S.2 – Rigid materials

Material flammability class	IEC standard
5VA regarded better than 5VB	IEC 60695-11-20
5VB regarded better than V-0	IEC 60695-11-20
V-0 regarded better than V-1	IEC 60695-11-10
V-1 regarded better than V-2	IEC 60695-11-10
V-2 regarded better than HB40	IEC 60695-11-10
HB40 regarded better than HB75	IEC 60695-11-10
HB75	IEC 60695-11-10

Table S.3 – Very thin materials

Material flammability class	ISO standard
VTM-0 regarded better than VTM-1	ISO 9773
VTM-1 regarded better than VTM-2	ISO 9773
VTM-2	ISO 9773

When VTM materials are used, relevant electrical and mechanical requirements should also be considered.

Wood and wood-based material with a thickness of at least 6 mm is considered to fulfil the **V-1** requirement. Wood-based material is material in which the main ingredient is machined natural wood, coupled with a binder.

EXAMPLE Wood-based materials are materials incorporating ground or chipped wood, such as hard fibre board or chip board.

S.5 Flammability test for fire enclosure materials of equipment with a steady-state power exceeding 4 000 W

Fire enclosure materials are tested according to IEC 60695-11-20:1999, using the plate procedure of IEC 60695-11-20:1999, 8.3.

For the purpose of this standard, the following additional requirements apply to the specified clauses of IEC 60695-11-20:1999.

Clause 7 of IEC 60695-11-20:1999 – Specimen, end product testing

For fire enclosures, each test specimen consists of either a complete fire enclosure or a section of the fire enclosure representing the thinnest significant wall thickness and including any ventilation opening (plate procedure).

Subclause 8.1 of IEC 60695-11-20:1999 – Conditioning

Prior to being tested, the samples are conditioned in a circulating air oven for a period of 7 days (168 h), at a temperature 10 K higher than the maximum temperature of the part

measured during the test of 5.4.1.4 or 70 °C, whichever is the higher, and then cooled to room temperature.

Subclause 8.3 of IEC 60695-11-20:1999 – Plate procedure

The test flame is applied to an inside surface of the test specimen at a point judged to be likely to become ignited because of its proximity to a source of ignition.

If a vertical part is involved, the flame is applied at an angle of approximately 20° from the vertical.

If ventilation openings are involved, the flame is applied to an edge of an opening, otherwise to a solid surface. In all cases, the tip of the flame is to be in contact with the test specimen.

The values of duration of application of the test flame are as follows:

- the test flame is applied for 5 s and removed for 5 s;*
- the test flame application and removal is repeated four more times at the same location (total of five flame applications).*

Subclause 8.4 of IEC 60695-11-20:1999 – Classification

The existing text is replaced by the following.

The test specimens shall comply with all of the following:

- after every application of the test flame, the test specimen shall not be consumed completely; and*
- after the fifth application of the test flame, any flame shall extinguish within 1 min.*

*No burning of the specified cotton indicator or **wrapping tissue** should occur.*

Annex T (normative)

Mechanical strength tests

T.1 General

In general, this annex describes a number of tests that are invoked by this standard. Compliance criteria are specified in the clause that invokes a particular test.

No tests are applied to handles, levers, knobs, the face of CRTs or to transparent or translucent covers of indicating or measuring devices, unless parts at ES3 are **accessible** when the handle, lever, knob or cover is removed.

T.2 Steady force test, 10 N

A steady force of $10\text{ N} \pm 1\text{ N}$ is applied to the component or part under consideration for a short time duration of approximately 5 s.

T.3 Steady force test, 30 N

The test is conducted by means of the straight unjointed version of the applicable test probe of Figure V.1 or Figure V.2, applied with a force of $30\text{ N} \pm 3\text{ N}$ for a short time duration of approximately 5 s.

T.4 Steady force test, 100 N

*The test is conducted by subjecting the external **enclosure** to a steady force of $100\text{ N} \pm 10\text{ N}$ over a circular plane surface 30 mm in diameter for a short time duration of approximately 5 s, applied in turn to the top, bottom, and sides.*

T.5 Steady force test, 250 N

*The test is conducted by subjecting the external **enclosures** to a steady force of $250\text{ N} \pm 10\text{ N}$ over a circular plane surface 30 mm in diameter for a short time period of approximately 5 s, applied in turn to the top, bottom and sides.*

T.6 Enclosure impact test

*A sample consisting of the complete **enclosure** or a portion thereof, representing the largest unreinforced area is supported in its normal position. A solid, smooth, steel sphere of 50 mm $\pm 1\text{ mm}$ in diameter and with a mass of 500 g $\pm 25\text{ g}$, is used to perform the following tests:*

- on horizontal surfaces, the sphere is to fall freely from rest through a vertical distance of 1 300 mm $\pm 10\text{ mm}$ onto the sample (see Figure T.1);*
- on vertical surfaces, the sphere is suspended by a cord and swung as a pendulum in order to apply a horizontal impact, dropping through a vertical distance of 1 300 mm $\pm 10\text{ mm}$ onto the sample (see Figure T.1).*

*For evaluating a part that acts as a **fire enclosure** only, the test is done as above, but the vertical distance is 410 mm $\pm 10\text{ mm}$.*

Alternatively horizontal impacts may be simulated on vertical or sloping surfaces by mounting the sample at 90° to its normal position and applying the vertical impact test instead of the pendulum test.

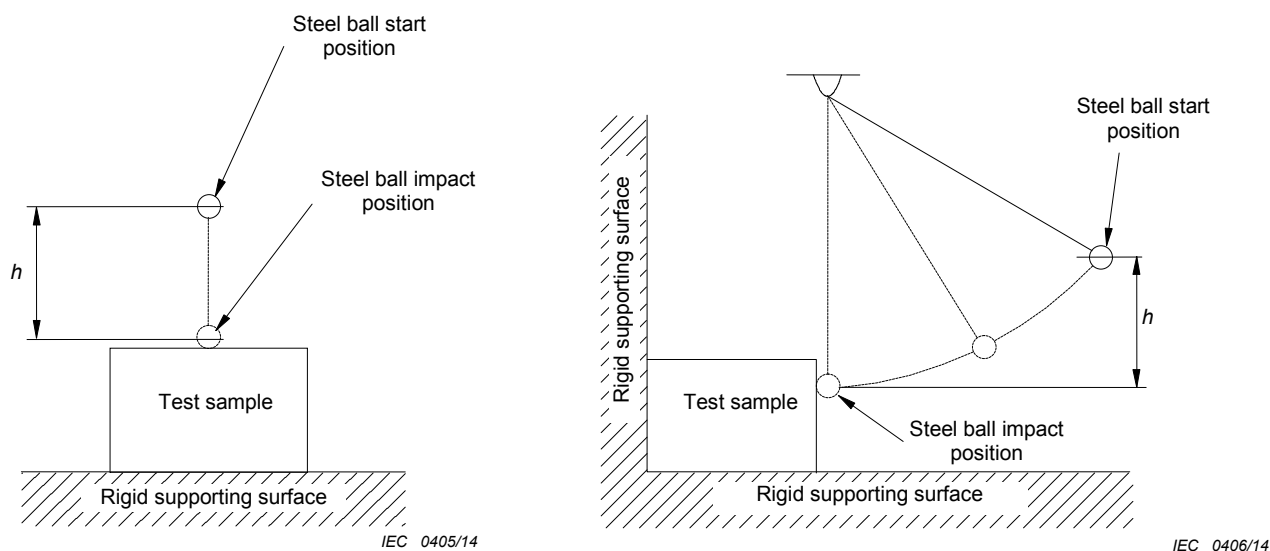

Figure T.1 – Impact test using sphere

T.7 Drop test

A sample of the complete equipment is subjected to three impacts that result from being dropped onto a horizontal surface in positions likely to produce the most adverse results.

The height of the drop shall be:

- 750 mm ± 10 mm for desk-top or table-top equipment and **moveable equipment**;
- 1 000 mm ± 10 mm for **hand-held equipment, direct plug-in equipment and transportable equipment**.
- 500 mm ± 10 mm for a part acting as a **fire enclosure only** of desk-top equipment and **moveable equipment**;
- 350 mm ± 10 mm for a part acting as a **fire enclosure only** of **hand-held equipment, direct plug-in equipment and transportable equipment**.

The horizontal surface consists of hardwood at least 13 mm thick, mounted on two layers of plywood each 18 mm ± 2 mm thick, all supported on a concrete or equivalent non-resilient floor.

T.8 Stress relief test

Stress relief is checked by the mould stress relief test of IEC 60695-10-3 or by the test procedure described below or by the inspection of the construction and the available data where appropriate.

One sample consisting of the complete equipment, or of the complete **enclosure** together with any supporting framework, is placed in a circulating air oven at a temperature 10 K higher than the maximum temperature observed on the sample during the heating test of 5.4.1.4.2, but not less than 70 °C, for a period of 7 h, then cooled to room temperature.

For large equipment where it is impractical to condition a complete **enclosure**, a portion of the **enclosure** representative of the complete assembly with regard to thickness and shape, including any mechanical support members, may be used.

NOTE Relative humidity need not be maintained at a specific value during this test.

T.9 Impact test

The test sample is supported over its whole area and shall be subjected to a single impact, specified in Table T.1. If the sample is made of glass, the impact shall be applied in a location representing the centre of the glass.

The impact specified shall be caused by allowing a solid, smooth, steel ball of $50 \text{ mm} \pm 1 \text{ mm}$ in diameter and with the mass of $500 \text{ g} \pm 25 \text{ g}$ to fall freely from rest through a vertical distance not less than specified in Table T.1, as shown in Figure T.1, and strike the sample with the specified impact in a direction perpendicular to the surface of the sample.

Table T.1 – Impact force

Part	Result	Impact J	Height mm
Unless otherwise specified below, any glass used as a safeguard against class 3 energy sources	Class 3 energy sources	3,5	714
Glass on floor standing equipment	Skin-lacerations	3,5	714
Glass on portable equipment, table-top equipment and on fixed mounted equipment	Skin-lacerations	2	408
Glass serving only as a fire enclosure	PS energy source	1	204
Glass lenses that are provided for the attenuation of UV radiation	Exposure to UV radiation	0,5	102
To apply the required impact, the height is calculated by $H = E / (g \times m)$ where H is the vertical distance in metres with a tolerance of $\pm 10 \text{ mm}$; E is the impact energy in Joules; g is the gravitational acceleration of $9,81 \text{ m/s}^2$; m is the mass of the steel ball in kilograms.			

T.10 Glass fragmentation test

The test sample is supported over its whole area and precautions shall be taken to ensure that particles will not be scattered upon fragmentation. Then the test sample is shattered with a centre punch placed approximately 15 mm in from the midpoint of one of the longer edges of the test sample. After a maximum of 5 min of fracture, and without using any aid to vision, except spectacles if normally worn, the particles are counted in a square of 50 mm side located approximately at the centre of the area of coarsest fracture and excluding any area within 15 mm of any edge or hole.

The test sample shall fragment in such a way that the number of particles counted in a square with sides of 50 mm shall not be less than 45.

T.11 Test for telescoping or rod antennas

The end piece of telescoping or rod antennas shall be subjected to a 20 N force along the major axis of the antenna for a period of 1 min. In addition, if the end piece is attached by screw threads, a loosening torque is to be applied to the end pieces of five additional samples. The torque is to be gradually applied with the rod fixed. When the specific torque is reached, it is to be maintained for no more than 15 s. The holding time for any one sample shall be not less than 5 s and the average holding time of the five samples shall be not less than 8 s.

The value of torque is given in Table T.2.

Table T.2 – Torque values for end-piece test

End-piece diameter mm	Torque Nm
< 8,0	0,3
≥ 8,0	0,6

Annex U (normative)

Mechanical strength of CRTs and protection against the effects of implosion

U.1 General

This annex specifies mechanical strength of CRTs, how to protect against the effects of implosion and how a protective screen can withstand mechanical forces.

CRTs with a maximum face dimension exceeding 160 mm shall be either intrinsically protected with respect to effects of implosion and to mechanical impact, or the **enclosure** of the equipment shall provide adequate protection against the effects of an implosion of the CRT.

The face of a non-intrinsically protected CRT shall be provided with an effective screen that cannot be removed by hand. If a separate screen of glass is used, it shall not contact the surface of the CRT.

The CRT, other than the face of an intrinsically protected CRT, shall not be **accessible** to an **ordinary person**.

A protective film attached to the faceplate of the picture tube as part of the implosion protection system shall be covered on all edges by the **enclosure** of the equipment.

If the equipment is provided with a CRT with protective film attached to the faceplate as part of the safety implosion system, an **instructional safeguard** shall be provided in accordance with Clause F.5:

- element 1a: not available
- element 2: “Warning” or equivalent word or text
- element 3: “Risk of injury” or equivalent text
- element 4: “The CRT in this equipment uses a protective film on the face. This film shall not be removed as it serves a safety function and removal will increase the risk of injury” or equivalent text

The **instructional safeguard** shall be provided in the instructions.

Compliance is checked by inspection, by measurement, and by the tests of

- *IEC 61965 for intrinsically protected CRTs, including those having integral protective screens;*
- *Clauses U.2 and U.3 for equipment having non-intrinsically protected CRTs;*
- *Annex V for application of probes for the enclosure.*

NOTE 1 A picture tube CRT is considered to be intrinsically protected with respect to the effects of implosion if, when it is correctly mounted, no additional protection is necessary.

NOTE 2 To facilitate the tests, the CRT manufacturer is requested to indicate the most vulnerable area on the CRTs to be tested.

U.2 Test method and compliance criteria for non-intrinsically protected CRTs

The equipment, with the CRT and the protective screen in position, is placed on a horizontal support at a height of (750 ± 50) mm above the floor, or directly on the floor if the equipment is obviously intended to be positioned on the floor.

*The CRT is imploded inside the **enclosure** of the equipment by the following method.*

Cracks are propagated in the envelope of each CRT. An area on the side or on the face of each CRT is scratched with a diamond stylus and this area is repeatedly cooled with liquid nitrogen or the like until a fracture occurs. To prevent the cooling liquid from flowing away from the test area, a dam of modelling clay or the like should be used.

NOTE Suitable scratch patterns are found in Figure 6 of IEC 61965:2003.

After this test, within 5 s of the initial fracture, no particle (a single piece of glass having a mass greater than 0,025 g) shall have passed a 250 mm high barrier, placed on the floor, 500 mm from the projection of the front of the equipment.

U.3 Protective screen

A protective screen shall be adequately secured and resistant to mechanical forces.

Compliance is checked by the tests of Clause T.3, without cracking of the protective screen or loosening of its mounting.

Annex V (normative)

Determination of accessible parts

V.1 Accessible parts of equipment

V.1.1 General

An **accessible** part of an equipment is a part that can be touched by a body part. For the purposes of determining an **accessible** part, a body part is represented by one or more of the specified probes.

Accessible parts of an equipment may include parts behind a door, panel, removable cover, etc. that can be opened without the use of a **tool**.

Accessible parts do not include those that become **accessible** when floor standing equipment having a mass exceeding 40 kg is tilted.

For equipment intended for building-in or rack-mounting, or for subassemblies and the like for incorporation in larger equipment, **accessible** parts do not include those that are not **accessible** when the equipment or subassembly is installed according to the method of mounting or installation specified in the installation instructions.

A part is considered **accessible** if the instructions or markings intended to be followed require that a person physically contacts that part. This applies without test and irrespective of whether a **tool** is required to gain access.

V.1.2 Test method 1 – Surfaces and openings tested with jointed test probes

For surfaces and openings, the following jointed test probe is applied, without appreciable force and in any possible position, to the surfaces and openings of the equipment:

- *the test probe of Figure V.1 for equipment that is likely to be **accessible** to children;*

NOTE 1 Equipment intended for use in homes, schools, public and similar locations is equipment generally considered to be **accessible** to children, see also Clause F.4.

- *the test probe of Figure V.2 for equipment that is not likely to be **accessible** to children.*

*Where entry behind a door, panel, removable cover, etc. is possible without the use of a **tool**, or entry is directed by manufacturer instructions or marking, with or without the use of a **tool**, the test probe is applied to surfaces and openings in those areas.*

*Where the entire probe passes through a large opening (allowing entry of an arm but not of a shoulder), the probe shall be applied to all parts within a hemisphere with radius of 762 mm. The probe handle shall point along a path towards the large opening to simulate the hand on the end of the arm extending through the large opening. The plane of the hemisphere shall be the outside plane of the opening. Any part outside the 762 mm radius hemisphere is deemed not **accessible**.*

NOTE 2 The equipment can be dismantled to perform this test.

V.1.3 Test method 2 – Openings tested with straight unjointed test probes

Openings preventing access to a part by the applicable jointed test probe of Figure V.1 or Figure V.2 are further tested by means of a straight unjointed version of the respective test probe applied with a force of 30 N. If the unjointed probe enters the openings, test method 1

is repeated, except that the applicable jointed version of the test probe is pushed through the opening using any necessary force up to 30 N.

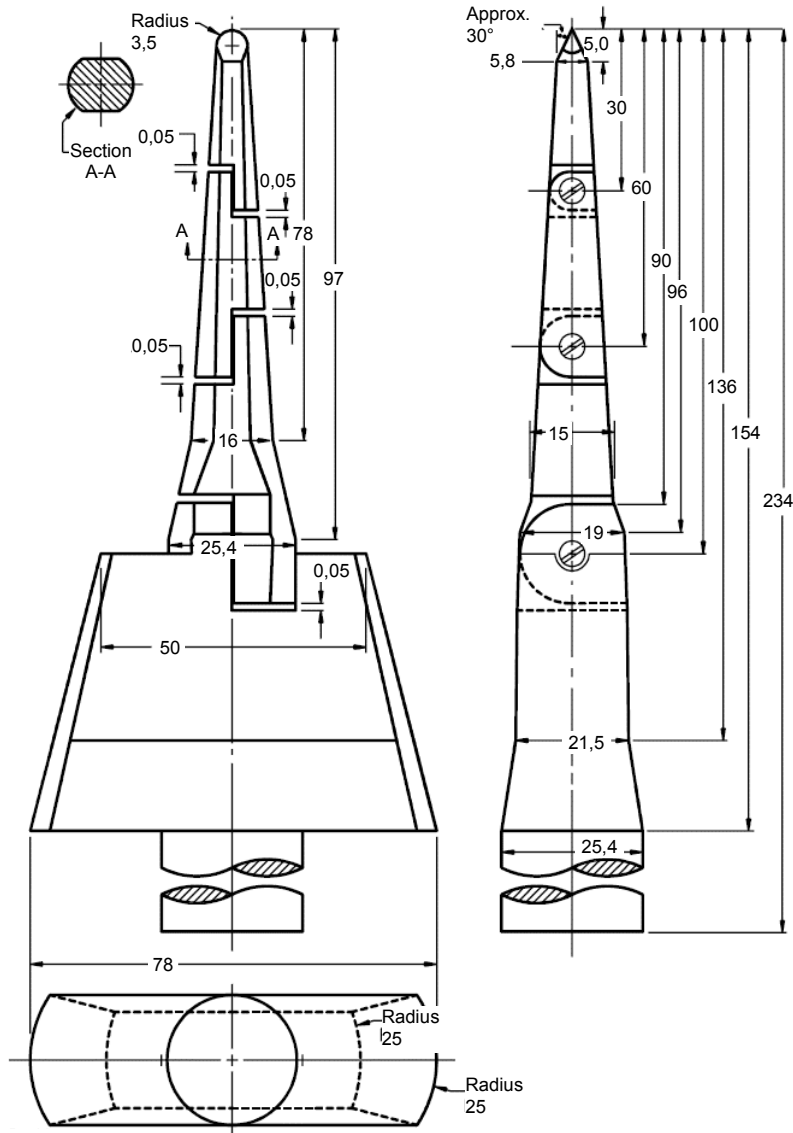

IEC 0407/14

Dimensions in millimetres

Tolerances on dimensions without specific tolerances:

angles: $\pm 15'$

on radii: $\pm 0,1$ mm

Tolerances on linear dimensions without specific tolerances:

≤ 15 mm: $\begin{matrix} 0 \\ -0,1 \end{matrix}$ mm

> 15 mm ≤ 25 mm: $\pm 0,1$ mm

> 25 mm: $\pm 0,3$ mm

Material of finger: heat-treated steel, for example.

Figure V.1 – Jointed test probe for equipment likely to be accessible to children

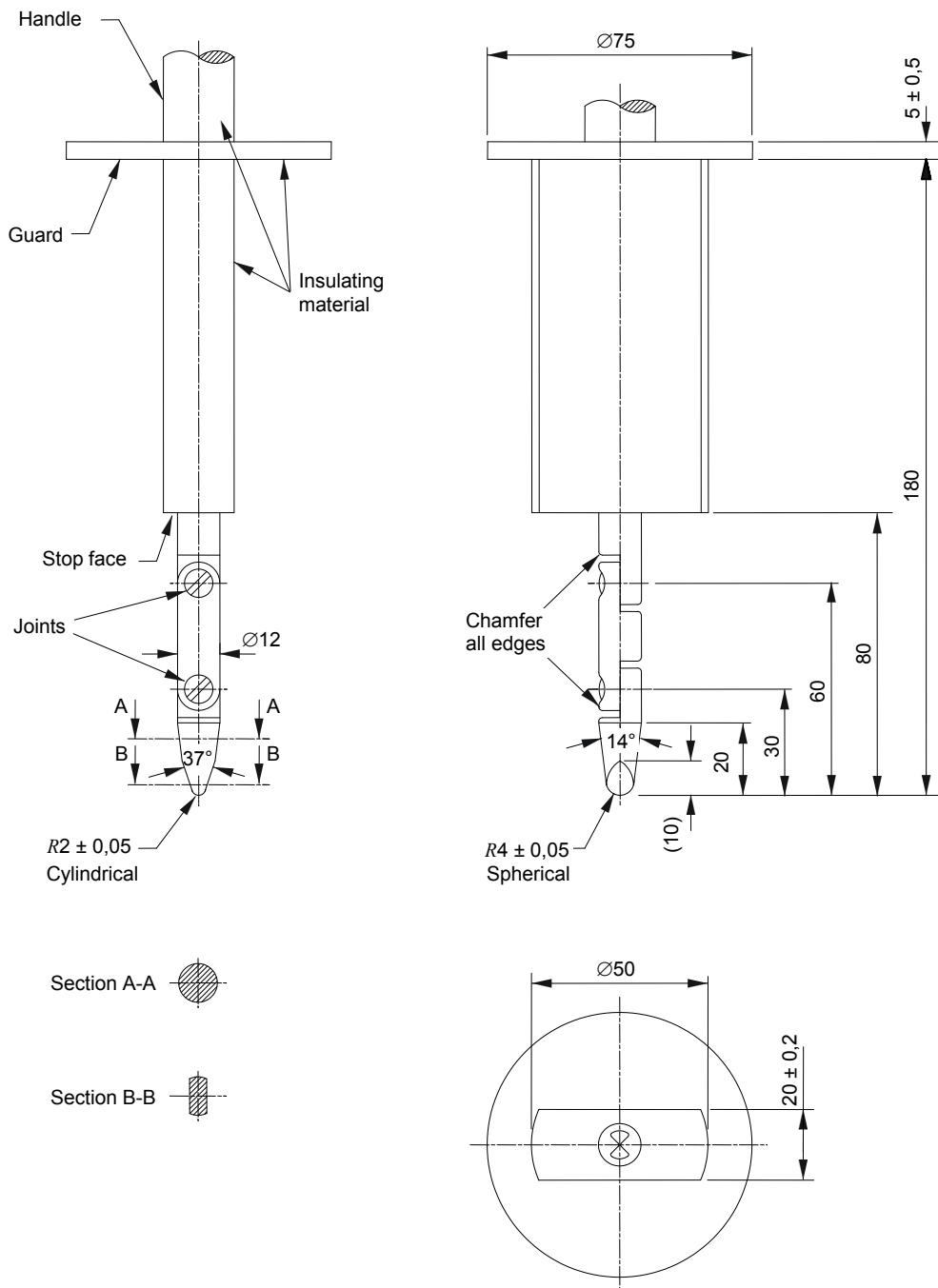

IEC 0408/14

Linear dimensions in millimetres

Tolerances on dimensions without specific tolerances:

14° and 37° angles: ± 15'

on radii: ± 0,1 mm

on linear dimensions:

≤ 15 mm: $\begin{matrix} 0 \\ -0,1 \end{matrix}$ mm

> 15 mm ≤ 25 mm: ± 0,1 mm

> 25 mm: ± 0,3 mm

NOTE This jointed test probe is taken from Figure 2, test probe B of IEC 61032:1997.

Figure V.2 – Jointed test probe for equipment not likely to be accessible to children

V.1.4 Test method 3 – Plugs, jacks, connectors

The blunt probe of Figure V.3 is applied without appreciable force and in any possible position to specified parts.

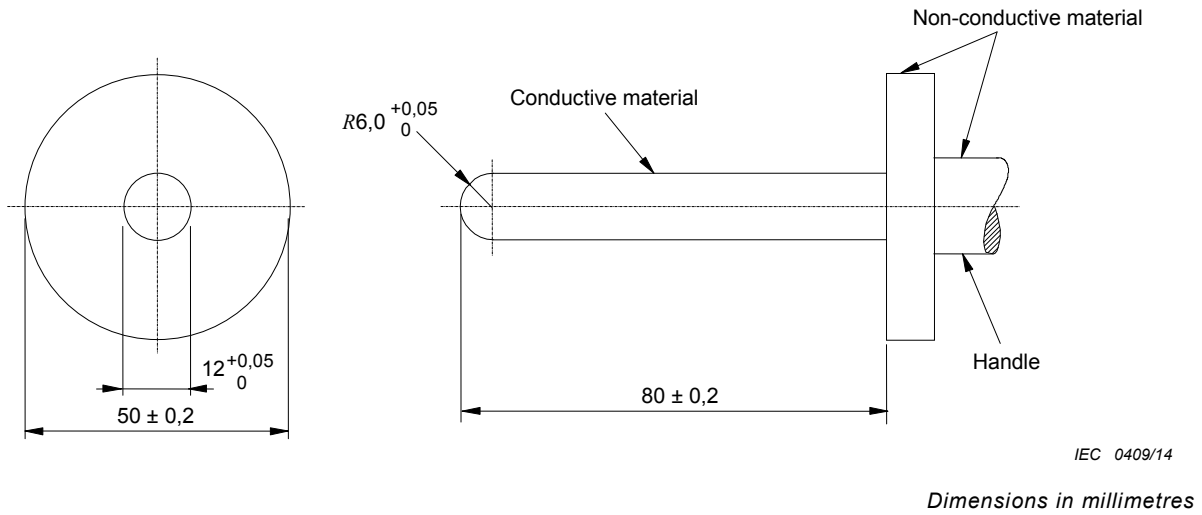
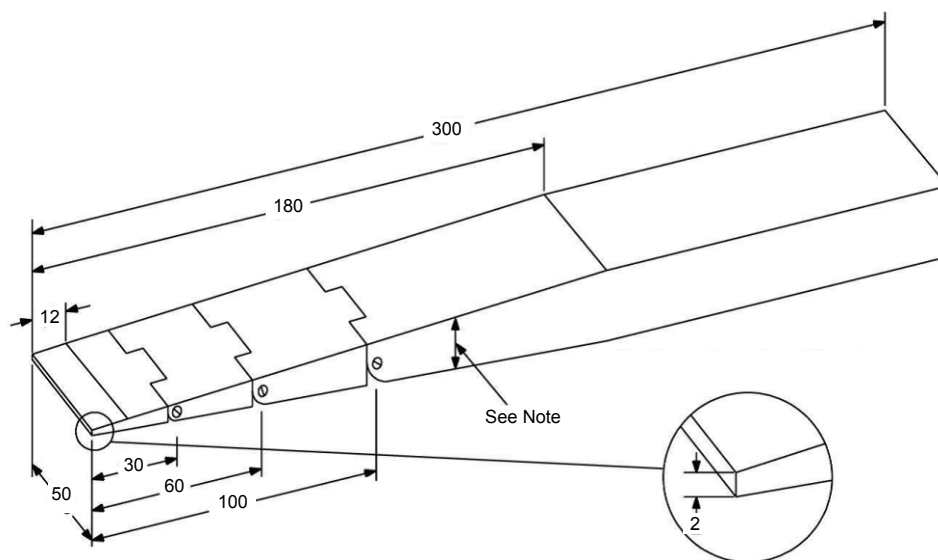

Figure V.3 – Blunt probe

V.1.5 Test method 4 – Slot openings

The wedge probe of Figure V.4 is applied as specified.



IEC 0410/14

Dimensions in millimetres

Tolerances on linear dimensions without specific tolerances:

≤ 25 mm: ± 0,13 mm

> 25 mm: ± 0,3 mm

NOTE The thickness of the probe varies linearly, with slope changes at the following points along the probe:

Distance from probe tip mm	Probe thickness mm
0	2
12	4
180	24

Figure V.4 – Wedge probe

V.1.6 Test method 5 – Terminals intended to be used by an ordinary person

The rigid test wire of the test probe of Figure V.5 is inserted into the applicable opening with a force up to $1\text{ N} \pm 0,1\text{ N}$ and with the length limited to $20\text{ mm} \pm 0,2\text{ mm}$. While inserted, the probe is moved in any angle with minimal force.

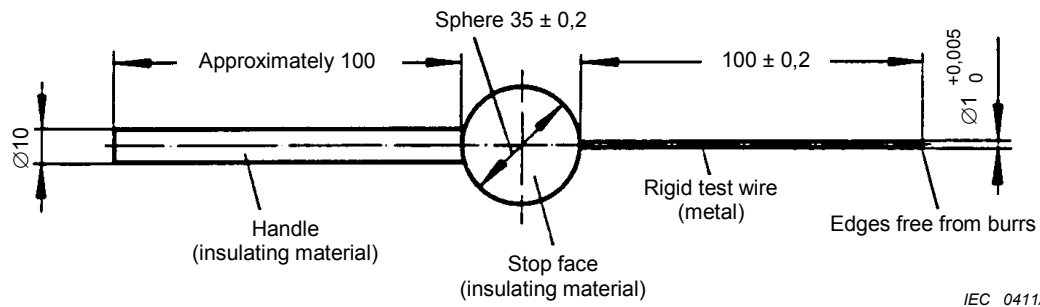

IEC 0411/14

Dimensions in millimetres

NOTE This probe is taken from Figure 4, IEC 61032:1997.

Figure V.5 – Terminal probe

V.2 Accessible part criterion

*If a part can be touched by the specified probe, then the part is **accessible**.*

Annex W (informative)

Comparison of terms introduced in this standard

W.1 General

This standard introduces new safety terms associated with the new safety concepts.

This annex identifies the relevant terms in this standard and, where different, compare them to the equivalent IEC/TC 64⁵ basic safety publications and other relevant safety publications.

Terms not in the tables below are either the same or substantially the same as in other IEC standards.

W.2 Comparison of terms

In the tables below, the text quoted from an IEC standard is in normal font. Remarks about IEC 62368-1 are in *italic font*.

Table W.1 – Comparison of terms and definitions in IEC 60664-1:2007 and IEC 62368-1

IEC 60664-1:2007	IEC 62368-1
3.2 clearance shortest distance in air between two conductive parts	3.3.12.1 clearance shortest distance in air between two conductive parts
3.3 creepage distance shortest distance along the surface of a solid insulating material between two conductive parts	3.3.12.2 creepage distance shortest distance along the surface of an insulating material between two conductive parts
3.4 solid insulation solid insulating material interposed between two conductive parts	3.3.5.5 solid insulation solid insulating material placed between two conductive parts or between a conductive part and a body part
3.5 working voltage highest r.m.s. value of the a.c. or d.c. voltage across any particular insulation which can occur when the equipment is supplied at rated voltage	3.3.14.9 working voltage highest voltage across any particular insulation that can occur when the equipment is supplied at rated voltage or any voltage in the rated voltage range under normal operating conditions
3.9 rated voltage value of voltage assigned by the manufacturer, to a component, device or equipment and to which operation and performance characteristics are referred	3.3.10.4 rated voltage value of voltage assigned by the manufacturer to a component, device or equipment and to which operation and performance characteristics are referred

⁵ IEC/TC 64: Electrical installations and protection against electric shock. Click on the IEC website for a list of publications issued by TC 64.

IEC 60664-1:2007	IEC 62368-1
<p>3.13 pollution degree numeral characterizing the expected pollution of the micro-environment</p>	<p>3.3.6.5 pollution degree numeral characterising the expected pollution of the micro-environment</p>
<p>3.19.1 type test test of one or more devices made to a certain design to show that the design meets certain specifications</p>	<p>3.3.6.11 type test test on a representative sample with the objective of determining if, as designed and manufactured, it can meet the requirements of this standard</p>
<p>3.9.2 rated impulse voltage impulse withstand voltage value assigned by the manufacturer to the equipment or to a part of it, characterizing the specified withstand capability of its insulation against transient overvoltages</p>	<p>3.3.14.2 mains transient voltage highest peak voltage expected at the power input to the equipment, arising from external transients on the mains</p>
<p>3.17.1 functional insulation insulation between conductive parts which is necessary only for the proper functioning of the equipment</p>	<p>3.3.5.3 functional insulation insulation between conductive parts which is necessary only for the proper functioning of the equipment</p>
<p>3.17.2 basic insulation insulation of hazardous-live-parts which provides basic protection</p>	<p>3.3.5.1 basic insulation insulation to provide basic safeguard against electric shock</p>
<p>3.17.3 supplementary insulation independent insulation applied in addition to basic insulation for fault protection</p>	<p>3.3.5.6 supplementary insulation independent insulation applied in addition to basic insulation to provide supplementary safeguard for fault protection against electric shock</p>
<p>3.17.4 double insulation insulation comprising both basic insulation and supplementary insulation</p>	<p>3.3.5.2 double insulation insulation comprising both basic insulation and supplementary insulation</p>
<p>3.17.5 reinforced insulation insulation of hazardous-live-parts which provides a degree of protection against electric shock equivalent to double insulation</p>	<p>3.3.5.4 reinforced insulation single insulation system that provides a degree of protection against electric shock equivalent to double insulation</p>
<p>3.19.2 routine test test to which each individual device is subjected during or after manufacture to ascertain whether it complies with certain criteria</p>	<p>3.3.6.7 routine test test to which each individual device is subjected during or after manufacture to ascertain whether it complies with certain criteria</p>
<p>3.19.3 sampling test test on a number of devices taken at random from a batch</p>	<p>3.3.6.8 sampling test test on a number of devices taken at random from a batch</p>

Table W.2 – Comparison of terms and definitions in IEC 61140:2001 and IEC 62368-1

IEC 61140:2001 terms	IEC 62368-1 terms
<p>3.1.1 basic protection</p> <p>protection against electric shock under fault-free conditions</p>	<p><i>For consistency throughout the standard the term "safeguard" is used to describe the device or scheme that provides protection against an energy source.</i></p> <p>3.3.11.1 basic safeguard</p> <p>safeguard that provides protection under normal operating conditions and under abnormal operating conditions whenever an energy source capable of causing pain or injury is present in the equipment</p>
<p>3.10.2 supplementary insulation</p> <p>Independent insulation applied in addition to basic insulation, for fault protection</p>	<p>3.3.11.15 supplementary safeguard</p> <p>safeguard applied in addition to the basic safeguard that is or becomes operational in the event of failure of the basic safeguard</p>
<p>3.4 live part</p> <p>conductor or conductive part intended to be energized in normal operation, including a neutral conductor, but by convention not a PEN conductor or PEM conductor or PEL conductor</p> <p>NOTE 1 This concept does not necessarily imply a risk of electric shock.</p> <p>NOTE 2 For definitions of PEM and PEL see IECV 195-02-13 and 195-02-14.</p>	<p><i>The term live part is not used.</i></p> <p><i>In accordance with the IEC 61140 definition, ES1, ES2 and ES3 are all live parts</i></p>
<p>3.5 hazardous-live-part</p> <p>live part that, under certain conditions, can give a harmful electric shock</p> <p>NOTE In case of high voltage, a hazardous voltage may be present on the surface of solid insulation. In such a case the surface is considered to be a hazardous-live-part.</p>	<p><i>The term hazardous-live-part is not used.</i></p> <p><i>In accordance with the IEC 61140 definition, an ES3 source is a hazardous-live-part.</i></p>
<p>3.26 extra-low-voltage (ELV)</p> <p>any voltage not exceeding the relevant voltage limit specified in IEC/TS 61201</p>	<p><i>No equivalent term. See ES1.</i></p>
<p>3.26.1 SELV system</p> <p>an electrical system in which the voltage cannot exceed ELV:</p> <ul style="list-style-type: none"> – under normal conditions; and – under single-fault conditions, including earth faults in other circuits 	<p>ES1</p> <p><i>ES1 is a voltage not exceeding the relevant voltage limit specified in IEC/TS 61201 or a current not exceeding the relevant current limit specified in IEC/TS 60479-1</i></p> <ul style="list-style-type: none"> – under normal conditions; and – under single fault conditions

IEC 61140:2001 terms	IEC 62368-1 terms
<p>3.28 limited-current-source</p> <p>device supplying electrical energy in an electric circuit</p> <ul style="list-style-type: none"> – with protective-separation from hazardous-live-parts, and – that ensures that the steady-state touch current and charge are limited to non-hazardous levels, under normal and fault conditions 	<p>ES1 <i>ES1 is a voltage not exceeding the relevant voltage limit specified in IEC/TS 61201 or a current not exceeding the relevant current limit specified in IEC/TS 60479-1</i></p> <ul style="list-style-type: none"> – under normal conditions; and – under single fault conditions.
<p>5.1.6 Limitation of steady-state touch current and charge</p> <p>Limitation of steady-state touch current and charge shall prevent persons or animals from being subjected to values of steady-state touch current and charge liable to be hazardous or perceptible.</p> <p>NOTE For persons, the following values (a.c. values for frequencies up to 100 Hz) are given as guidance:</p> <ul style="list-style-type: none"> – A steady-state current flowing between simultaneously accessible conductive parts through a pure resistance of 2 000 Ω not exceeding the threshold of perception, a.c. 0,5 mA or d.c. 2 mA are recommended. – Values not exceeding the threshold of pain a.c. 3,5 mA or d.c. 10 mA may be specified. 	<p><i>ES1 current limit is 0,5 mA a.c. and 2 mA d.c.</i></p> <p><i>ES2 current limit is 5 mA a.c., 25 mA d.c. (these values are taken from IEC/TS 60479-1)</i></p>
<p>No equivalent term</p>	<p>3.3.11.12 safeguard physical part or system or instruction specifically provided to reduce the likelihood of injury, or, for fire, to reduce the likelihood of ignition or spread of fire</p>
<p>No equivalent term. Based on double insulation</p>	<p>3.3.11.2 double safeguard safeguard comprising both a basic safeguard and a supplementary safeguard</p>
<p>No equivalent term. Based on reinforced insulation</p>	<p>3.3.11.11 reinforced safeguard single safeguard that is operational under</p> <ul style="list-style-type: none"> – normal operating conditions, – abnormal operating conditions, and – single fault conditions.
<p>No equivalent term. Roughly equivalent to a warning</p>	<p>3.3.11.5 instructional safeguard an instruction invoking specified behaviour to avoid contact with or exposure to a class 2 or class 3 energy source</p>

IEC 61140:2001 terms	IEC 62368-1 terms
No equivalent term	3.3.11.7 precautionary safeguard instructed person behaviour to avoid contact with or exposure to a class 2 energy source based on supervision or instructions given by a skilled person
No equivalent term	3.3.11.14 skill safeguard skilled person behaviour to avoid contact with or exposure to a class 2 or class 3 energy source based on education and experience
The term normal condition is used in IEC 61140, but not defined	3.3.7.4 normal operating condition mode of operation that represents as closely as possible the most severe conditions of normal use that can reasonably be expected
No equivalent term	3.3.7.1 abnormal operating condition temporary operating condition that is not a normal operating condition and is not a single fault condition of the equipment itself
The term single fault is used in IEC 61140, but not defined	3.3.7.10 single fault condition fault under normal operating condition of a single safeguard (but not a reinforced safeguard) or of a single component or a device

Table W.3 – Comparison of terms and definitions in IEC 60950-1:2005 and IEC 62368-1

IEC 60950-1:2005 terms	IEC 62368-1 terms
<p>1.2.8.8 SELV circuit</p> <p>secondary circuit that is so designed and protected that under normal operating conditions and single fault conditions, its voltages do not exceed a safe value</p>	<p>5.2.1.1 ES1</p> <p>ES1 is a class 1 electrical energy source with levels not exceeding ES1 limits under normal operating conditions and abnormal operating conditions that do not lead to a single fault conditions and not exceeding ES2 limits under single fault conditions.</p> <p>NOTE ES1 may be accessible to an ordinary person.</p>
<p>1.2.8.11 TNV circuit</p> <p>circuit that is in the equipment and to which the accessible area of contact is limited and that is so designed and protected that, under normal operating conditions and single fault conditions (see 1.4.14 of IEC 60950-1:2005), the voltages do not exceed specified limit values.</p> <p>A TNV circuit is considered to be a secondary circuit in the meaning of this standard</p>	<p>5.2.1.2 ES2</p> <p>ES2 is a class 2 electrical energy source with levels not exceeding ES2 limits under normal operating conditions, abnormal operating conditions, and single fault conditions, but is not ES1.</p> <p>NOTE ES2 may be accessible to an instructed person.</p>
<p>1.2.8.12 TNV-1 circuit</p> <p>TNV circuit</p> <ul style="list-style-type: none"> – whose normal operating voltages do not exceed the limits for an SELV circuit under normal operating conditions and – On which overvoltages from telecommunication networks and cable distribution systems are possible 	<p>ES 1 on which transients according to Table 14, ID numbers 1, 2 and 3 are possible</p> <p>NOTE The electrical characteristics are not identical to TNV circuits but will give equivalent level of safety.</p>
<p>1.2.8.13 TNV-2 circuit</p> <p>TNV circuit</p> <ul style="list-style-type: none"> – whose normal operating voltages exceed the limits for an SELV circuit under normal operating conditions and – which is not subject to overvoltages from telecommunication networks 	<p>ES2</p> <p>NOTE The electrical characteristics are not identical to TNV circuits but will give equivalent level of safety.</p>

IEC 60950-1:2005 terms	IEC 62368-1 terms
<p>1.2.8.14 TNV-3 circuit</p> <p>TNV circuit</p> <ul style="list-style-type: none"> – whose normal operating voltages exceed the limits for an SELV circuit under normal operating conditions and – on which overvoltages from telecommunication networks and cable distribution systems are possible 	<p>ES 2 on which transients according to Table 14, ID numbers 1, 2 and 3 are possible</p> <p>NOTE The electrical characteristics are not identical to TNV circuits but will give equivalent level of safety.</p>
<p>1.2.13.6 USER</p> <p>any person, other than a service person The term user in this standard is the same as the term operator and the two terms can be interchanged</p>	<p>3.3.8.2 ordinary person</p> <p>person who is neither a skilled person nor an instructed person</p>
<p>1.2.13.7 operator</p> <p>see user (1.2.13.6 of IEC 60950-1:2005)</p>	<p>See 3.3.8.2</p>
<p>1.2.13.8 telecommunication network</p> <p>metallically terminated transmission medium intended for communication between equipment that may be located in separate buildings, excluding:</p> <ul style="list-style-type: none"> – the mains system for supply, transmission and distribution of electrical power, if used as a telecommunication transmission medium; – cable distribution systems; – SELV circuits connecting units of information technology equipment <p>NOTE 1 The term telecommunication network is defined in terms of its functionality, not its electrical characteristics. a telecommunication network is not itself defined as being either an SELV circuit or a TNV circuit. Only the circuits in the equipment are so classified.</p> <p>NOTE 2 A telecommunication network may be:</p> <ul style="list-style-type: none"> – publicly or privately owned; – subject to transient overvoltages due to atmospheric discharges and faults in power distribution systems: – subject to longitudinal (common mode) voltages induced from nearby power lines or electric traction lines. <p>NOTE 3 Examples of telecommunication networks are:</p> <ul style="list-style-type: none"> – a public switched telephone network; – a public data network; – an integrated Services Digital Network (ISDN); – a private network with electrical interface characteristics similar to the above. 	<p>3.3.1.1 external circuit</p> <p>electrical circuit that is external to the equipment and is not mains</p> <p>NOTE The relevant external circuits are identified in Table 14</p>

IEC 60950-1:2005 terms	IEC 62368-1 terms
<p><i>None</i></p>	<p>3.3.8.1 instructed person a person instructed or supervised by a skilled person as energy sources and who can responsibly use equipment and precautionary safeguards with respect to those energy sources</p>
<p>1.2.13.5 service person person having appropriate technical training and experience necessary to be aware of hazards to which that person may be exposed in performing a task and of measures to minimize the risks to that person or other persons</p>	<p>3.3.8.3 skilled person person with relevant education or experience to enable him or her to avoid dangers and to reduce the likelihood of risks that may be created by the equipment</p>
<p>1.2.13.14 cable distribution system metallically terminated transmission medium using coaxial cable, mainly intended for transmission of video and/or audio signals between separate buildings or between outdoor antennas and buildings, excluding:</p> <ul style="list-style-type: none"> – the mains system for supply, transmission and distribution of electric power, if used as a communication transmission medium; – telecommunication networks; – SELV circuits connecting units of information technology equipment <p>NOTE 1 Examples Of cable distribution systems are:</p> <ul style="list-style-type: none"> – local area cable networks, community antenna television systems and master antenna television systems providing video and audio signal distribution; – outdoor antennas including satellite dishes, receiving antennas, and other similar devices. <p>NOTE 2 cable distribution systems may be subjected to greater transients than telecommunication networks.</p>	<p>3.3.1.1 external circuit electrical circuit that is external to the equipment and is not mains</p> <p>NOTE The relevant external circuits are identified in Table 14.</p>

Table W.4 – Comparison of terms and definitions in IEC 60728-11 and IEC 62368-1

IEC 60728-11 terms	IEC 62368-1 terms
<p>3.1.3 cable networks (for television signals, sound signals and interactive services) general overall term used to define CATV-networks, MATV-networks. SMATV-networks and individual receiving networks; these networks can be used in downstream and upstream directions</p> <p>3.1.4 CATV network or community antenna television network network designed to provide sound and television signals as well as signals for interactive services to communities</p> <p>3.1.20 MATV network or master antenna television network network designed to provide sound and television signals as well as signals for interactive services to households in one or more buildings</p> <p>3.1.31 SMATV network or satellite master antenna television network network designed to provide sound and television signals as well as signals for interactive services, received by satellite receiving antenna eventually combined with terrestrial TV and/or radio signals, to households in one or more buildings</p>	<p>3.3.1.1 external circuit electrical circuit that is external to the equipment and is not mains</p> <p>NOTE The relevant external circuits are identified in Table 14.</p>

Table W.5 – Comparison of terms and definitions in IEC 62151 and IEC 62368-1

IEC 62151 terms	IEC 62368-1 terms
<p>3.1.3 telecommunication network a metallicly terminated transmission medium intended for communication between equipments that may be located in separate buildings, excluding:</p> <ul style="list-style-type: none"> – the mains systems for supply, transmission and distribution of electrical power, if used as a telecommunication transmission medium; – television distribution systems using cable. <p>NOTE 1 The term telecommunication network is defined in terms of its functionality, not its electrical characteristics. a telecommunication network is not itself defined as being a TNV circuit. Only the circuits in equipment are so classified.</p> <p>NOTE 2 A telecommunication network may be</p> <ul style="list-style-type: none"> – publicly or privately owned; – subject to transient overvoltages due to atmospheric discharges and faults in power distribution systems; – subject to permanent longitudinal (common mode) voltages induced from nearby power lines or electric traction lines. <p>NOTE 3 Examples of telecommunication networks are</p> <ul style="list-style-type: none"> – a public switched telephone network; – a public data network; – an ISDN network; – a private network with electrical interface characteristics similar to the above. 	<p>3.3.1.1 external circuit electrical circuit that is external to the equipment and is not mains</p> <p>NOTE The relevant external circuits are identified in Table 14.</p>
<p>3.5.4 TNV-0 circuit a TNV circuit:</p> <ul style="list-style-type: none"> – whose normal operating voltages do not exceed a safe value under normal operating conditions and under single fault conditions; – which is not subject to overvoltages from telecommunication networks <p>NOTE The limiting values of voltage under normal operating and single fault conditions are specified in 4.1.</p>	<p>5.2.1.1 ES1 ES1 is a class 1 electrical energy source with levels not exceeding ES1 limits under normal operating conditions and abnormal operating conditions and not exceeding ES2 limits under single fault conditions.</p> <p>NOTE 1 ES1 may be accessible to an ordinary person.</p> <p>NOTE 2 The electrical characteristics are not identical but will give equivalent level of safety</p>

IEC 62151 terms	IEC 62368-1 terms
<p>3.5.3 TNV circuit a circuit which is in the equipment and to which the accessible area of contact is limited (except for a TNV-0 circuit) and that is so designed and protected that, under normal operating and single fault conditions, the voltages do not exceed specified limiting values A TNV circuit is considered to be a secondary circuit in the meaning of this standard. NOTE The voltage relationships between TNV CIRCUITS are shown in table 1.</p>	<p>5.2.1.2 ES2 ES2 is a class 2 electrical energy source with levels not exceeding ES2 limits under normal operating conditions, abnormal operating conditions, or single fault conditions, but is not ES1. NOTE 1 ES2 may be accessible to an instructed person. NOTE 2 The electrical characteristics are not identical to TNV circuits but will give an equivalent level of safety.</p>

Table W.6 – Comparison of terms and definitions in IEC 60065 and IEC 62368-1

IEC 60065 terms	IEC 62368-1 terms
<p>2.2.12 professional apparatus apparatus for use in trades, professions or industries and which is not intended for sale to the general public NOTE The designation should be specified by the manufacturer</p>	<p>No equivalent term.</p>
<p>2.4.3 directly connected to the mains electrical connection with the mains in such a way that a connection to either pole of the mains causes in that connection a permanent current equal to or greater than 9 A, protective devices in the apparatus being not short-circuited NOTE A current of 9 A is chosen as the minimum breaking current of a 6 A fuse</p>	<p>No equivalent term. In accordance with the IEC 60065 definition, an ES3 source would be considered directly connected to the mains.</p>
<p>2.4.4 conductively connected to the mains electrical connection with the mains in such a way that a connection through a resistance of 2 000 Ω to either pole of the mains causes in that resistance a permanent current greater than 0,7 mA (peak), the apparatus not being connected to earth</p>	<p>No equivalent term. In accordance with the IEC 60065 definition, an ES3 or ES2 source could be considered conductively connected to the mains.</p>

IEC 60065 terms	IEC 62368-1 terms
<p>2.4.7 telecommunication network metallic-terminated transmission medium intended for communication between apparatus that may be located in separate buildings, excluding:</p> <ul style="list-style-type: none"> - the mains systems for supply, transmission and distribution of electrical power, if used as a telecommunication transmission medium; television - distribution systems using cable <p>NOTE 1 The term telecommunication network is defined in terms of its functionality, not its electrical characteristics. a telecommunication network is not itself defined as being either a TNV circuit. Only the circuits in the apparatus are so classified.</p> <p>NOTE 2 A telecommunication network may be:</p> <ul style="list-style-type: none"> - publicly or privately owned; - subject to transient overvoltages due to atmospheric discharges and faults in power distribution systems; - subject to longitudinal (common mode) voltages induced from nearby power lines or electric traction lines. <p>NOTE 3 Examples of telecommunication networks are:</p> <ul style="list-style-type: none"> - a public switched telephone network; - a public data network; - an ISDN network; - a private network with electrical interface characteristics similar to the above. 	<p>3.3.1.1 external circuit electrical circuit that is external to the equipment and is not mains</p> <p>NOTE The relevant external circuits are identified in Table 14</p>
<p>2.6.10 hazardous live electrical condition of an object from which a hazardous touch current (electric shock) could be drawn (see 9.1.1)</p>	<p>The term hazardous-live is not used.</p> <p>In accordance with the IEC 60065 definition, an ES3 source is hazardous live.</p>
<p>2.8.6 instructed person person adequately advised or supervised by skilled persons to enable him or her to avoid dangers and to prevent risks which electricity may create</p>	<p>3.3.8.1 instructed person person instructed or supervised by a skilled person as to energy sources and who can responsibly uses equipment safeguards and precautionary safeguards with respect to those energy sources [IEV 826-18-02, modified]</p> <p>NOTE Supervised, as used in the definition, means having the direction and oversight of the performance of others.</p>

IEC 60065 terms	IEC 62368-1 terms
<p>2.8.11 potential ignition source possible fault which can start a fire if the open-circuit voltage measured across an interruption or faulty contact exceeds a value of 50 V (peak) a.c. or d.c. and the product of the peak value of this voltage and the measured r.m.s. current under normal operating conditions exceeds 15 VA.</p> <p>Such a faulty contact or interruption in an electrical connection includes those which may occur in conductive patterns on printed boards.</p> <p>NOTE An electronic protection circuit may be used to prevent such a fault from becoming a potential ignition source.</p>	<p>3.3.9.2 arcing PIS location where an arc may occur due to the opening of a conductor or contact</p> <p>NOTE 1 An electronic protection circuit or additional constructional measures may be used to prevent a location from becoming an arcing PIS.</p> <p>NOTE 2 A faulty contact or interruption in an electric connection that may occur in conductive patterns on printed boards is considered to be within the scope of this definition.</p>

Bibliography

IEC 60050 (all parts), *International Electrotechnical Vocabulary* (available at <http://www.electropedia.org>)

IEC 60130-2, *Connectors for frequencies below 3 MHz – Part 2: Connectors for radio receivers and associated sound equipment*

IEC 60130-9, *Connectors for frequencies below 3 MHz – Part 9: Circular connectors for radio and associated sound equipment*

IEC 60169-3, *Radio-frequency connectors – Two pin connector for twin balanced aerial feeders*

IEC 60269-2, *Low-voltage fuses – Part 2: Supplementary requirements for fuses for use by authorized persons (fuses mainly for industrial application) – Examples of standardized systems of fuses A to I*

IEC 60309-1, *Plugs, socket-outlets and couplers for industrial purposes – Part 1: General requirements*

IEC 60364 (all parts), *Low-voltage electrical installations*

IEC 60364-4-44:2007, *Low-voltage electrical installations – Part 4-44: Protection for safety – Protection against voltage disturbances and electromagnetic disturbances*

IEC/TS 60479-1:2005, *Effects of current on human beings and livestock – Part 1: General aspects*

IEC 60601-2-4, *Medical electrical equipment – Part 2-4: Particular requirements for the safety of cardiac defibrillators*

IEC 60664-4:2005, *Insulation coordination for equipment within low-voltage systems – Part 4: Consideration of high-frequency voltage stress*

IEC 60664-5, *Insulation coordination for equipment within low-voltage systems – Part 5: Comprehensive method for determining clearances and creepage distances equal to or less than 2 mm*

IEC 60906-3, *IEC System of plugs and socket-outlets for household and similar purposes – Part 3: SELV plugs and socket-outlets, 16 A 6V, 12 V, 24 V, 48 V, a.c. and d.c.*

IEC 61032:1997, *Protection of persons and equipment by enclosures – Probes for verification*

IEC 61508-1, *Functional safety of electrical/electronic/programmable electronic safety-related systems – Part 1: General requirements*

IEC 61558-2-1, *Safety of power transformers, power supplies, reactors and similar products – Part 2-1: Particular requirements and tests for separating transformers and power supplies incorporating separating transformers for general applications*

IEC 61558-2-4, *Safety of transformers, reactors, power supply units and similar products for supply voltages up to 1 100 V – Part 2-4: Particular requirements and tests for isolating transformers and power supply units incorporating isolating transformers*

IEC 61558-2-6, *Safety of transformers, reactors, power supply units and similar products for voltages up to 1 100 V – Part 2-6: Particular requirements and tests for safety isolating transformers and power supply units incorporating isolating transformers*

IEC 61643-1, *Low-voltage surge protective devices – Part 1: Surge protective devices connected to low-voltage power distribution systems – Requirements and tests*

IEC 61643-21, *Low voltage surge protective devices – Part 21: Surge protective devices connected to telecommunications and signalling networks – Performance requirements and testing methods*

IEC 61643-311, *Components for low-voltage surge protective devices – Part 311: Specification for gas discharge tubes (GDT)*

IEC 61643-321, *Components for low-voltage surge protective devices -Part 321: Specifications for avalanche breakdown diode (ABD)*

IEC 61643-331, *Components for low-voltage surge protective devices -Part 331: Specification for metal oxide varistors (MOV)*

IEC 62151:2000, *Safety of equipment electrically connected to a telecommunication network*

IEC/TR 62368-2, *Audio/video, information and communication – Technology equipment – Part 2: Explanatory information (under consideration)*

ISO/IEC Guide 37, *Instructions for use of products of consumer interest*

ISO/IEC Guide 51, *Safety aspects – Guidelines for their inclusion in standards*

ITU-T Recommendation K.27, *Bonding configurations and earthing inside a telecommunication building*

ITU-T Recommendation K.44, *Resistibility tests for telecommunication equipment exposed to overvoltages and overcurrents – Basic Recommendation*

ITU-T P.360, *Efficiency of devices for preventing the occurrence of excessive acoustic pressure by telephone receivers*

ACIF G624:2005 – *Network interface voltage levels, Australia*

AS/NZS 3112, *Approval and test specification—Plugs and socket outlets*

BS 1363, *13 A plugs, socket-outlets, adaptors and connection units. Specification for rewirable and non-rewirable 13 A fused plugs*

CFR 21, Part 1020: Code of Federal Regulations (USA) Part 1020: Performance standards for ionizing radiation emitting products

Consolidated Regulations of Canada (CRC), c.1370, *Radiation Emitting Devices*

EN 71-1:2011, *Safety of toys – Part 1: Mechanical and physical properties*

EN 50491-3:2009, *General requirements for Home and Building Electronic Systems (HBES) and Building Automation and Control Systems (BACS) – Part 3: Electrical safety requirements*

EN 60728-11 – *Cable networks for television signals, sound signals and interactive services – Part 11: Safety*

European Council Directive 96/29/Euratom of 13 May 1996 Laying down Basic Safety Standards for the Protection of the Health of Workers and the General Public against the Danger Arising from Ionising Radiation

International Commission on Radiological Protection (ICRP) Publication 60: Recommendations of ICRP

SOMMAIRE

AVANT-PROPOS	346
INTRODUCTION	349
0 Principes de la présente norme relative à la sécurité des produits	349
0.1 Objectif	349
0.2 Personnes	349
0.2.1 Généralités	349
0.2.2 Personne ordinaire	349
0.2.3 Personne avertie	349
0.2.4 Personne qualifiée	349
0.3 Modèle pour les douleurs et les blessures	350
0.4 Sources d'énergie	350
0.5 Protections	351
0.5.1 Généralités	351
0.5.2 Protection de l'équipement	352
0.5.3 Protection de l'installation	352
0.5.4 Protection individuelle	353
0.5.5 Protections de comportement	353
0.5.6 Protection dans des conditions d'entretien par une personne ordinaire ou avertie	354
0.5.7 Protections dans des conditions d'entretien par une personne qualifiée	354
0.5.8 Exemples de caractéristiques de protection	354
0.6 Douleurs ou blessures dues à l'électricité (choc électrique)	355
0.6.1 Modèles pour des douleurs ou blessures dues à l'électricité	355
0.6.2 Modèles pour se protéger contre les douleurs ou blessures dues à l'électricité	356
0.7 Incendie d'origine électrique	357
0.7.1 Modèles pour les incendies d'origine électrique	357
0.7.2 Modèles pour se protéger contre les incendies d'origine électrique	358
0.8 Blessures dues à des substances dangereuses	359
0.9 Blessures dues à un choc mécanique	359
0.10 Blessures dues à la chaleur (brûlure de la peau)	360
0.10.1 Modèles pour les blessures dues à la chaleur	360
0.10.2 Modèles pour se protéger contre les douleurs ou blessures dues à la chaleur	361
0.11 Blessures dues à des rayonnements	362
1 Domaine d'application	363
2 Références normatives	364
3 Termes, définitions et abréviations	370
3.1 Abréviations des sources d'énergie	370
3.2 Autres abréviations	370
3.3 Termes et définitions	371
3.3.1 Termes relatifs aux circuits	373
3.3.2 Termes relatifs à l'enveloppe	373
3.3.3 Termes relatifs à l'équipement	374